

Programmable Electronic Thermostat
 1 Heat/1 Cool, Auto Changeover, Fan Speed Control, Hardwire
 Part No. 668811301



- 7-Day, 5-2-Day or 5-1-1-Day Programmable
- Configurable
- Single-Stage Heat/Cool Systems
- Single-Stage Heat Pump Systems
- Two-Speed Fan Speed Selection
- Large Display With Backlight
- Selectable Fahrenheit or Celsius
- Compatible with Gas, Oil, or Electric
- SimpleSet™ Field Programming
- Status Indicator Light
- Relay Outputs (minimum voltage drop in thermostat)
- Remote Sensor Compatible
- Ideally Suited for:
 - Residential (New Construction/Replacement)
 - Light Commercial



Parts Diagram

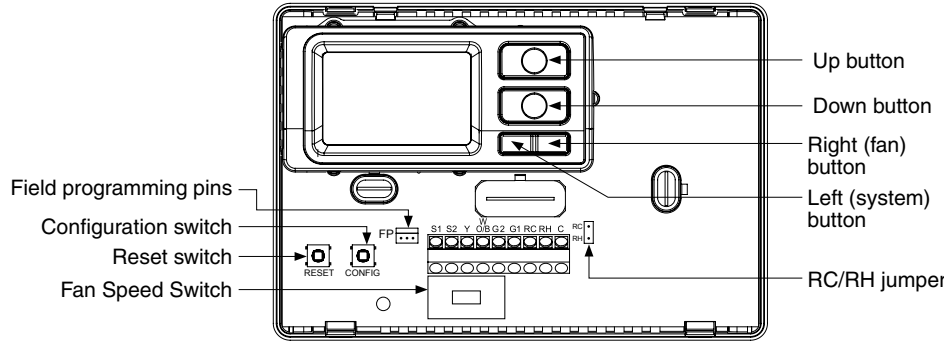

Icon Descriptions

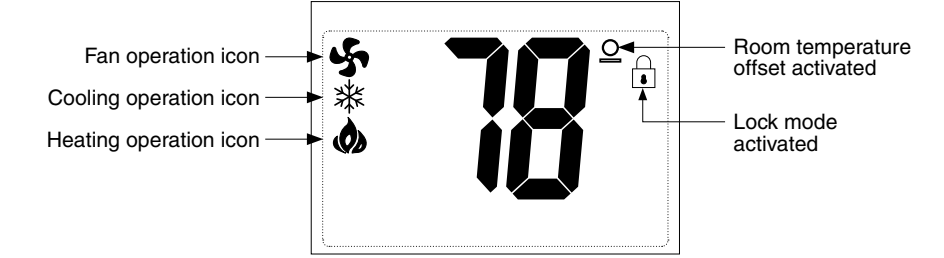

Specifications

Electrical rating: • 24 VAC (18-30 VAC)
 • 1 amp maximum per terminal
 • 3 amp maximum total load

Temperature control range: 45°F to 90°F (7°C to 32°C) **Accuracy:** ± 1°F (± 0.5°C)

System configurations: 1-stage heat, 1-stage cool, heat pump, gas, oil, electric

Timing: *Anti-short Cycle:* 4 minutes
 Backlight Operation

Terminations: S1, S2, Y, W/O/B, G2, G1, RC, RH, C

Important Safety Information

WARNING
Always turn off power at the main power supply before installing, cleaning, or removing thermostat.

- This thermostat is for 24 VAC applications only; do not use on voltages over 30 VAC
- Do not short across terminals of gas valve or system control to test operation; this will damage your thermostat and void your warranty
- All wiring must conform to local and national electrical and building codes
- Use this thermostat only as described in this manual

Package Contents/Tools Required

Package includes: Daikin thermostat on base, thermostat cover, wiring labels, screws and wall anchors, Installation, Operation and Application Guide

Tools required for installation: Drill with 3/16" bit, hammer, screwdriver

To Remove Existing Thermostat

WARNING
ELECTRICAL SHOCK HAZARD – Turn off power at the main service panel by removing the fuse or switching the appropriate circuit breaker to the OFF position before removing the existing thermostat.

1. Turn off power to the heating and cooling system by removing the fuse or switching the appropriate circuit breaker off.
2. Remove cover of old thermostat. This should expose the wires.
3. Label the existing wires with the enclosed wire labels before removing wires.
4. After labeling wires, remove wires from wire terminals.
5. Remove existing thermostat base from wall.
6. Refer to the following section for instructions on how to install this thermostat.

To Install Thermostat

WARNING
ELECTRICAL SHOCK HAZARD – Turn off power at the main service panel by removing the fuse or switching the appropriate circuit breaker to the OFF position before removing the existing thermostat.

IMPORTANT: Thermostat installation must conform to local and national building and electrical codes and ordinances.

❖ **Note:** Mount the thermostat about five feet above the floor. Do not mount the thermostat on an outside wall, in direct sunlight, behind a door, or in an area affected by a vent or duct.

1. Turn off power to the heating and cooling system by removing the fuse or switching the appropriate circuit breaker off.
2. To remove cover, pull gently at the seam at the top.
3. Put thermostat base against the wall where you plan to mount it (Be sure wires will feed through the wire opening in the base of the thermostat).
4. Mark the placement of the mounting holes.
5. Set thermostat base and cover away from working area.
6. Using a 3/16" drill bit, drill holes in the places you have marked for mounting.
7. Use a hammer to tap supplied anchors in mounting holes.
8. Align thermostat base with mounting holes and feed the control wires through slit in thermal intrusion barrier and into wire opening.
9. Use supplied screws to mount thermostat base to wall.
10. Insert stripped, labeled wires in matching wire terminals.

WARNING
Be sure exposed portion of wires does not touch other wires.

11. Gently tug wire to be sure of proper connection. Double check that each wire is connected to the proper terminal.
12. Turn on power to the system at the main service panel.
13. Configure thermostat (see Page 12) to match the type of system you have.
14. Replace cover on thermostat by snapping it in place.
15. Test thermostat operation as described in "Testing the Thermostat" (Page 19).

Wiring Diagrams

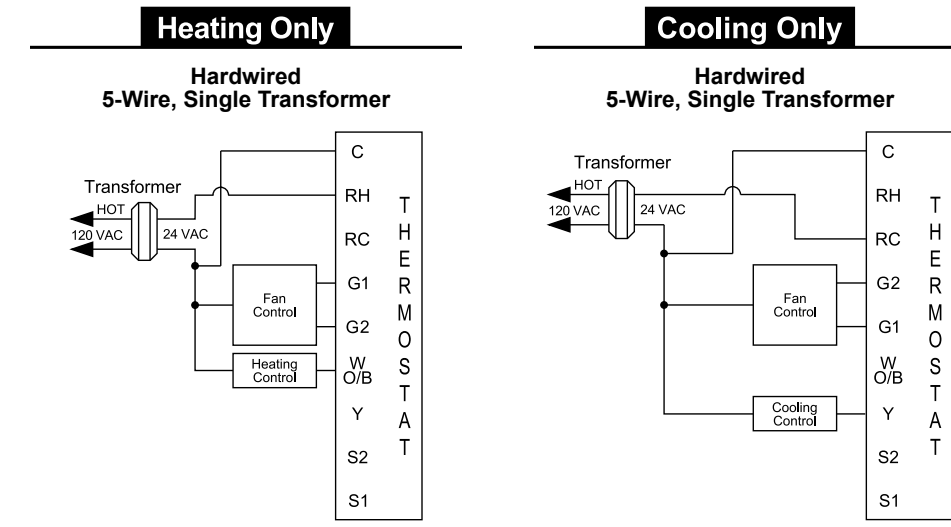

Heating/Cooling

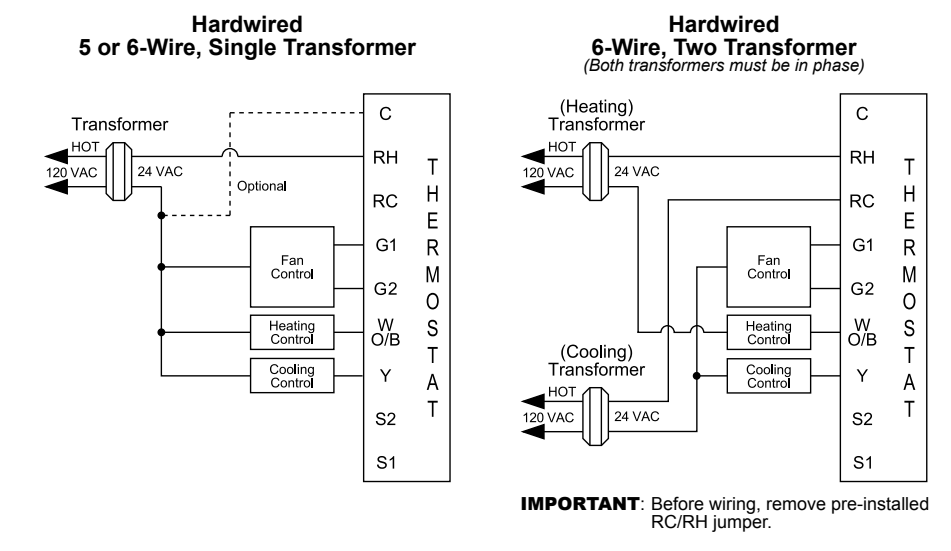

Heat Pump

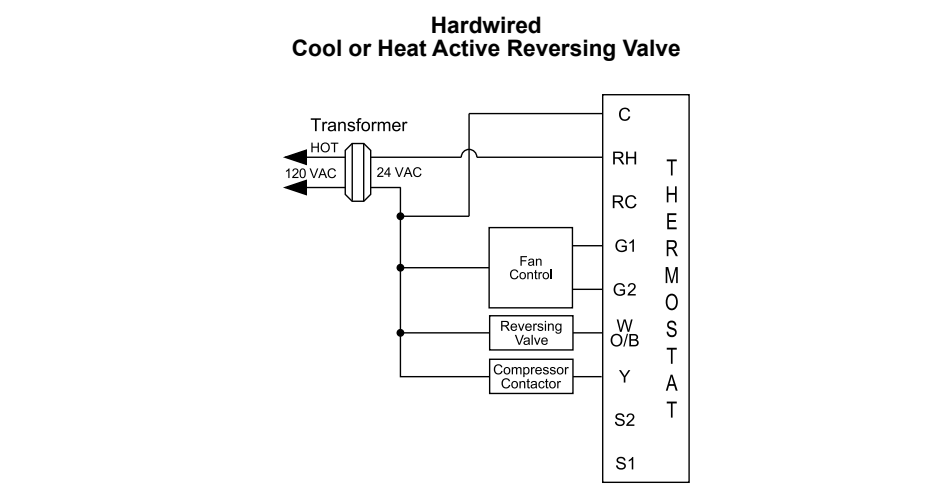

Remote or Outdoor Sensor Installation (Optional)

1. Remove cover from remote sensor housing.
2. Select an appropriate location for mounting the remote sensor.
3. Mount remote sensor unit using hardware provided.
4. Install two strand shielded wire between remote sensor and thermostat. Shielded wire must be used. **Do not** run remote sensor wire in conduit with other wires.
 - **Wire 1** should run between the S1 terminal on the thermostat and the S1 terminal on the remote sensor
 - **Wire 2** should run between the S2 terminal on the thermostat and the S2 terminal on the remote sensor
 - Connect the shielding of the wire to the S2 terminal on the thermostat
5. Configure the thermostat to operate with the remote sensor (see Configuration Mode setting 10).

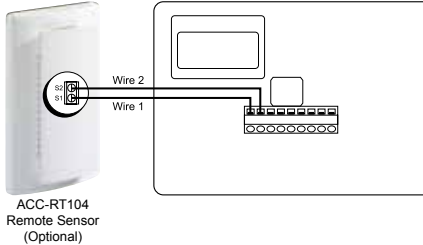

❖ **Note:** Remote or outdoor sensor reading can be displayed by simultaneously pressing the **Down** and **SYS** buttons.

Configuration Mode

The configuration mode is used to set the Daikin thermostat to match your heating/cooling system. The Daikin thermostat functions with heat pump, air conditioning, gas, oil or electric heat systems. To configure the Daikin thermostat, perform the following steps:

1. Verify the Daikin thermostat is in the **OFF** mode. Press the **SYS** (left) button until off mode displays.
2. Remove the cover of the thermostat by gently pulling near one of the corners at the top of the thermostat.
3. Press the **CONFIG** button for 1 second while the Daikin thermostat is in **OFF** mode.

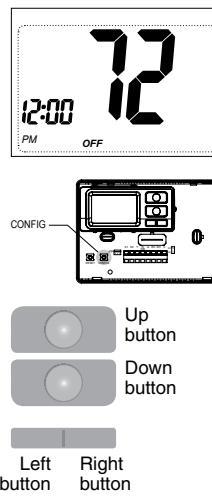

Press the up or down button to change settings within each screen.

Press the right button to advance to the next screen.
 ❖ **Note:** Pressing the **left** button will return you to the previous screen.

To exit configuration mode, press the **CONFIG** switch for 1 second.

Configuration Mode Settings

The setup screens for Configuration Mode are as follows:

1. **Temperature Scale** (F or C)
 Choose Fahrenheit or Celsius. Press the **up** or **down** button to select. Press the **right** button to advance to the next screen.
2. **Temperature Differential** (1°F to 5°F) (0.5°C to 2.5°C)
 Set the number of degrees between your "setpoint" temperature and your "turn on" temperature. Press the **up** or **down** button to set differential value. Press the **right** button to advance to the next screen.

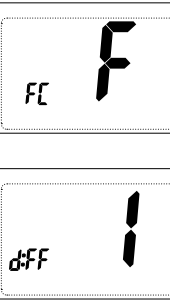

3. **Deadband** (1°F - 9°F) (1°C - 5°C)
 Set the minimum number of degrees between your heat setpoint and your cool setpoint in Autochangeover mode. Press the **up** or **down** button to set deadband value. Press the **right** button to advance to the next screen.

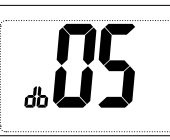

4. **System** – Set for heat pump, non-heat pump, reversing valve operation and number of compressors in your system. Choose between two heat pump settings or gas/oil or electric.

Choose	System	Reversing Valve Active	Number of Compressors or Compressor Stages	Type of Heat
Heat Pump	HP	O – Cool Active	1	
	HP	b – Heat Active	1	
Non-Heat Pump	Heat			Gas/Oil
	Heat			Electric

Press the **up** or **down** button to select.
 Press the **right** button to advance to the next screen.

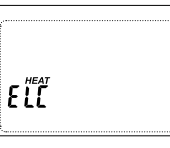

5. **Lockout** (0-8°, NITE, COOL-HEAT)
 Select the number of degrees set temperature can be changed during keypad lockout or select to lockout during NITE period only. COOL-HEAT lockout allows adjustment of the set temperatures to the maximum heat set temperature selected in Step 6 and minimum cool set temperature selected in Step 7.
 ❖ **Note:** The mode cannot be changed when the thermostat is locked. Press the **up** or **down** button to select. Press the **right** button to advance to the next screen.



6. **Maximum Heat Setpoint** (45°F to 90°F) (7°C to 32°C)
 Adjust to control the maximum heat set temperature allowed. Press the **up** or **down** button to select. Press the **right** button to advance to the next screen.



7. **Minimum Cool Setpoint** (45°F to 90°F) (7°C to 32°C)
 Adjust to control the minimum cool set temperature allowed. Press the **up** or **down** button to select. Press the **right** button to advance to the next screen.



8. **Room Temperature Offset** (+9°F to -9°F) (+5°C to -5°C)
 Adjust to calibrate displayed room temperature to match actual room temperature. ❖ **Note:** When not set to 0, 0 will display. Press the **up** or **down** button to select. Press the **right** button to advance to the next screen.



9. **Maximum Cycles Allowed Per Hour** (-, 2-6)
 - - = as many as needed, 2-6 = maximum cycles/hour. Press the **up** or **down** button to select. Press the **right** button to advance to the next screen.

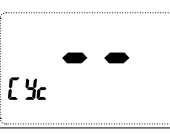

10. **Temperature Sensor** (1-4)
 1. Only on-board sensor determines room temperature.
 2. Only remote sensor determines room temperature.
 3. Average temperature of on-board and remote sensor.
 4. Only on-board sensor will be used until NITE period, and then only remote sensor is used.
 Press the **up** or **down** button to select. Press the **right** button to advance to the next screen.

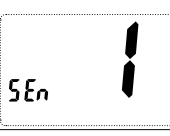

11. **Cooling Fan Delay Off Time** (0, 30, 60, 90 seconds)
 Select the fan purge time for cooling. Press the **up** or **down** button to select. Press the **right** button to advance to the next screen.
 ❖ **Note:** The Daikin control board provides a minimum Fan Off delay of 30 seconds, even if the thermostat is set for a 0 second delay.

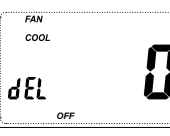

12. **Status Indicator Light** (Led 0 or 1)
 0 = Status indicator never on
 1 = Status indicator on with first stage
 Press the **up** or **down** button to select. Press the **CONFIG** button for 2 seconds to exit configuration.

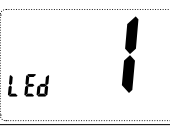

Mode of Operation

The Daikin thermostat is a programmable, manual or auto changeover, single-stage heat, single-stage cool thermostat. It functions with air conditioning, heat pumps, gas, oil or electric heat systems.

The thermostat activates the heating appliance when the room temperature is below the set heat temperature (by the differential temperature) and the red indicator light (configurable) on the thermostat will light. The Daikin thermostat will stop outputting and the red light will turn off when the call for heat has been satisfied. With heat pumps, the thermostat will not let the compressor come on for 4 minutes after it turns off. This protects your compressor.

When the room temperature is greater than the set cool temperature (by the differential temperature), the cooling device is activated and the green indicator light (configurable) on the thermostat will turn on. The Daikin thermostat will stop outputting and the green light will turn off when the call for cooling is satisfied. The thermostat will not let the compressor come on for 4 minutes after it turns off. This protects your compressor.

The Daikin thermostat has five possible operating modes: **OFF**, **Heat**, **Cool**, **Heat & Cool**, and **Program** mode. In off mode, the thermostat will not turn on heating or cooling devices. The manual fan can be turned on in all operating modes using the fan button, and the fan speed can be set in all operating modes using the fan speed switch. In heat mode, the thermostat controls the heating system. In the cool mode, the thermostat controls the cooling system. In heat & cool mode, the thermostat controls both the heating and cooling systems. In program mode, the thermostat will automatically be controlled by the set program. Program mode can function with heat mode, cool mode, or heat & cool mode. The clock display alternates with the set temperature display for heat & cool mode.

The program schedule can be overridden by changing the set temperature (up or down button). This puts the Daikin thermostat thermostat into a 2-hour temporary hold. After 2 hours, it will automatically return to the program schedule.

The programmable fan feature can be used to recirculate air while in **Program** mode. It is activated during the program schedule set up.

The Daikin thermostat also has a button lockout feature. This enables the thermostat to be set to the proper mode and temperature and locked so it cannot be tampered with.

Operating Modes

There are five possible operating modes for the Daikin thermostat. Off, Cool, Heat, and Cool & Heat modes are accessed by pressing the **SYS** (left) button. Program mode is accessed by pressing the **SYS** (left) and **FAN** (right) buttons simultaneously.

OFF Mode

- In this mode, the thermostat will not turn on the heating or cooling devices
- ** **Note:** The fan speed can be set in all operating modes using the fan speed switch.



Heat Mode

- In this mode, the thermostat controls the heating system. When the heat outputs, the flame icon  appears on the display.
- ** **Note:** For heat pumps, there is a four minute delay for your compressor to restart after it has turned off.

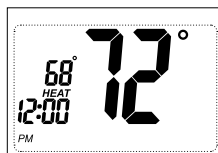

Cool Mode

- In this mode, the thermostat controls the cooling system. When the cooling outputs, the snowflake icon  appears on the display.
- ** **Note:** There is a four minute delay for your compressor to restart after it has turned off.

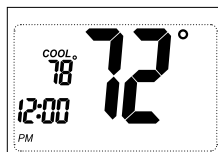

Cool and Heat Mode (Auto Changeover)

- In this mode, the thermostat controls the cooling and heating systems, automatically changing over from one to the other as needed.
- The timing display alternates with the set temperature every 10 seconds in the cool and heat mode.

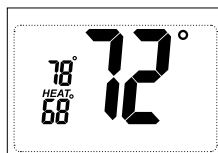

Program Mode

- In this mode, the program function is on (PROG displays), and the thermostat will automatically be controlled by the set program schedule. Program mode can function with heat mode, cool mode, or heat & cool mode. The program schedule can be overridden by changing the set temperature (up or down button). After 2 hours, the program schedule will automatically be resumed. To manually return to the program schedule, press the PROG button twice.

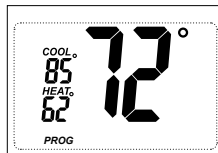
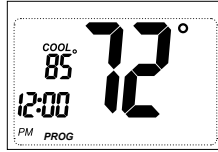
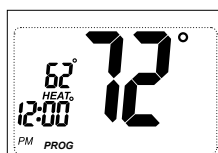

Testing the Thermostat

Once the thermostat is configured, it should be thoroughly tested.

CAUTION

Do not energize the air conditioning system when the outdoor temperature is below 50 degrees. It can result in equipment damage or personal injury.

Heat Test

- Press **SYS** (left) button until heat mode is displayed.
- Adjust the set temperature so it is 5 degrees above the room temperature.
- Heat should come on within a few seconds. Red LED may turn on.
- Adjust the set temperature 2 degrees below the room temperature and the heat should turn off. There may be a fan delay on your system.

** **Note:** For heat pumps, there is a four-minute delay to protect your compressor after it turns off. To bypass the compressor time delay, go to **OFF** mode for 5 seconds.



Cool Test

- Press **SYS** (left) button until cool mode is displayed.
- Adjust set temperature so it is 5 degrees below room temperature.
- A/C should come on within a few seconds. Green LED may turn ON.
- Adjust the set temperature 2 degrees above the room temperature and the A/C should turn off. There may be a fan delay on your system.

** **Note:** There is a four-minute time delay to protect the compressor after it turns off. To bypass the compressor time delay, go to **OFF** mode for 5 seconds.

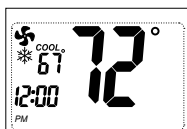

Fan Test

- Press **FAN** (right) button. Fan displays. Indoor fan turns ON.
- Press **FAN** (right) button. Indoor fan turns OFF.

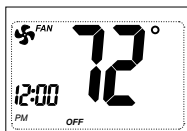

Setting the Time and Day of the Week

The time and day of the week must be set for your program schedule to operate correctly.

- Press the **SYS** (left) button until you are in the OFF mode.
- Press and hold the **PROG** button (**SYS** (left) and **FAN** (right) buttons pressed simultaneously) in for 6 seconds.
- Time displays (hour flashing).
Press the **up** or **down** button to adjust the hour.
- Press the **FAN** (right) button once to select minutes (minutes flashing).
Press the **up** or **down** button to adjust the minutes.



- Press the **FAN** (right) button once to select day of the week (TODAY flashing).
Press the **up** or **down** button to select current day of the week.

** **Note:** At any time, press the **SYS** (left) button to return to the previous screen or press the **FAN** (right) button to advance to the next screen.

Press the **PROG** button in for 2 seconds to lock values into memory and return to the OFF mode or press the **FAN** (right) button once to enter programming.

Programming

Program Overview

The Daikin programmable thermostat has four periods (MORN, DAY, EVE, NITE) that are customizable for each day of the week. Each period will have a start time, heat temperature, cool temperature and programmable fan option. The Daikin thermostat monitors the day and time, while maintaining the specific conditions you have chosen for each period in your program.

Setting the program schedule:

- Press the **SYS** (left) button until you are in **OFF** mode.
- Press and hold the **PROG** button (**SYS** and **FAN** buttons pressed simultaneously) for 6 seconds.
- Press the **FAN** (right) button 3 times.
- SUN thru SAT are blinking.



From this screen you have 2 options:

- Press the **FAN** (right) button to begin programming all 7 days at one time, or
- Press the up button to see the other programming options.

** **Note:** The days of the week shown on the display will be programmed simultaneously.

The screens are listed below.

Screen 1	SUN	MON	TUE	WED	THU	FRI	SAT
Screen 2		MON	TUE	WED	THU	FRI	SAT
Screen 3		MON					
Screen 4			TUE				
Screen 5				WED			
Screen 6					THU		
Screen 7						FRI	
Screen 8	SUN						SAT
Screen 9							SAT
Screen 10	SUN						

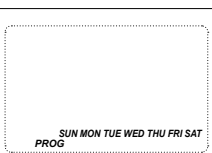

From any of the screens on Page 21, you can press the **FAN** (right) button to begin entering your program schedule. The days shown on the display will all be programmed simultaneously.

Once the **FAN** (right) button is pressed, **MORN** blinks. Use the **up** or **down** button to select a different period (**MORN**, **DAY**, **EVE**, **NITE**).

Press **FAN** (right) button to advance to the next screen. Transition time **hour** blinks. Use the **up** or **down** button to select a different hour.

Press **FAN** (right) button to advance to the next screen. Transition time **minutes** blink. Use the **up** or **down** button to select different minutes.

Press **FAN** (right) button to advance to the next screen. **Heat set temperature** displays. Use the **up** or **down** button to adjust the heat set temperature.

Press **FAN** (right) button to advance to the next screen. **Cool set temperature** displays. Use the **up** or **down** button to adjust the cool set temperature.

Press **FAN** (right) button to advance to the next screen. **Programmable fan** screen displays. Use the **up** or **down** button to select:

- Choose **Off** – Programmable fan disabled
- On** – Indoor fan on continuously

** **Note:** Programmable fan operates in Program mode only.

Repeat above steps to program the four periods per day.

When the program schedule is complete, press and hold the **PROG** button (**SYS** and **FAN** buttons pressed simultaneously) in for 2 seconds to return to the **OFF** mode.

Lockout Feature

The Daikin thermostat has a button lockout feature so the mode cannot be changed and the temperature adjustment is limited. Select the appropriate lockout from Configuration Mode Settings (Step 5, Page 13) of this guide.

To activate the LOCK feature:

- Simultaneously press the **SYS**, **FAN** and **UP** buttons for 10 seconds.
-  will display and the lockout function will be enabled.

To deactivate the LOCK feature, repeat steps 1 and 2 above.

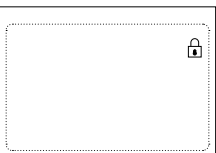

Factory Preprogramming

The Daikin thermostat comes preprogrammed with the following schedule:

	MORN	6:00 AM	DAY	8:00 AM	EVE	6:00 PM	NITE	10:00 PM
MONDAY thru SUNDAY	HEAT	70°F	HEAT	62°F	HEAT	70°F	HEAT	62°F
	COOL	78°F	COOL	85°F	COOL	78°F	COOL	82°F
	FAN	Off	FAN	Off	FAN	Off	FAN	Off

Personal Program Schedule

Use the following personal program schedule to record your settings:

	MORN	DAY	EVE	NITE
MONDAY 1	HEAT COOL FAN	HEAT COOL FAN	HEAT COOL FAN	HEAT COOL FAN
TUESDAY 2	HEAT COOL FAN	HEAT COOL FAN	HEAT COOL FAN	HEAT COOL FAN
WEDNESDAY 3	HEAT COOL FAN	HEAT COOL FAN	HEAT COOL FAN	HEAT COOL FAN
THURSDAY 4	HEAT COOL FAN	HEAT COOL FAN	HEAT COOL FAN	HEAT COOL FAN
FRIDAY 5	HEAT COOL FAN	HEAT COOL FAN	HEAT COOL FAN	HEAT COOL FAN
SATURDAY 6	HEAT COOL FAN	HEAT COOL FAN	HEAT COOL FAN	HEAT COOL FAN
SUNDAY 7	HEAT COOL FAN	HEAT COOL FAN	HEAT COOL FAN	HEAT COOL FAN

SimpleSet™ Field Programming

Requires SimpleSet™ Transfer Cable (68817901)

This feature is used for transferring configuration and program schedule from the master to the target thermostat. All thermostats for a job can be mounted and powered up. Configure and program one thermostat. This will be the master. The master will be used to copy the program to the rest of the thermostats.

Preparing the master to Send:

- The master must be powered with 24 VAC.
- Verify the master thermostat is in **OFF** mode.
- Press **SYS** (left) button until **OFF** mode displays.
- Remove cover of the master thermostat by gently pulling near one of the corners at the top of the thermostat.
- Press the **up** and **down** buttons and **CONFIG** switch simultaneously for 5 seconds.
- The **OUT** screen displays indicating the master thermostat is ready to transfer data.

** **Note:** Press the **up** and **down** buttons and **CONFIG** switch simultaneously for 5 seconds to exit from data transfer mode and to return the master to the **OFF** mode.

- Turn off power to the master and remove it from the wall.
- Connect the master to the target using the 3 wire connector. Attach one end to the Master's FP pins and the other end to the Target's FP pins.

** **Note:** Target thermostat must be powered with 24 VAC for field programming to occur

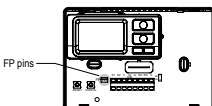
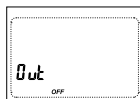

When the connection has been made correctly, the master thermostat will power up and the target will count from 5 down to 1. It will then display the **LOCK** confirming the data has been saved in memory.

When all target thermostats have been completed, reinstall the master thermostat.

Press the **up** and **down** buttons and the **CONFIG** switch simultaneously for 5 seconds to exit from the data transfer mode and to return the master thermostat to the **OFF** mode.

Troubleshooting

Symptom	Remedy
No display	Check for 24 VAC at thermostat; display is blank when 24 VAC is not present Time and day of week must be reset after extended power loss
System fan does not come on properly	Verify wiring is correct, check Gas/Electric Configuration (see Setting 4, Page 12)
All thermostat buttons are inoperative	Verify 24 VAC is present; unit locks out when 24 VAC is not present
No response with first button press	First button press activates backlight only
Program schedule activates at the wrong time	Check time (AM/PM) set on thermostat (see Setting the Time, Page 20)
Thermostat turns on and off too frequently	Adjust temperature differential (see Configuration Mode Setting 2, Page 11)
Thermostat does not follow program	Verify it is operating in program mode (PROG displays); check time (AM/PM); check if in 2 hour program override
Fan runs continuously	Press FAN (right) button to turn fan off
Fan turns on occasionally	Program Mode: Check programmable fan setting in program schedule (see Page 22)
Status indicator light not on during call	Turn status indicator function on (see Configuration Mode Setting 12, Page 15)
Room temperature is not correct	Calibrate thermostat (see Configuration Mode Setting 8, Page 14) If remote sensor is used, check S1 and S2 terminal connections
 displays when any button is pressed	Thermostat has the button lockout function activated (see Lockout Feature, Page 23 and Configuration Mode Setting 5, Page 13)
Er on display instead of room temp.	Check for a bad connection at S1 and S2 terminals, if used (see Configuration Mode Setting 10, Page 14)
Heat or Cool not coming on	Verify wiring is correct, verify RC/RH jumper is in place (for single transformer system)
Remote or outdoor sensor not accurate	Press SYS and Down buttons simultaneously to display remote or outdoor temperature. Verify connections at S1 and S2 terminals.
Problem not listed above	Press Reset button once*

* **Reset Button Function:** Time and day are reset, configuration and program settings are unchanged.

Daikin Training and Development

Now that you have made an investment in modern, efficient **Daikin** equipment, its care should be a high priority. For training information on all **Daikin** HVAC products, please visit us at www.DaikinApplied.com and click on Training, or call 540-248-9646 and ask for the Training Department.

Warranty

All **Daikin** equipment is sold pursuant to its standard terms and conditions of sale, including Limited Product Warranty. Consult your local **Daikin** Representative for warranty details. Refer to Form 933-430285Y. To find your local **Daikin** Representative, go to www.DaikinApplied.com.

Aftermarket Services

To find your local parts office, visit www.DaikinApplied.com or call **800-37PARTS (800-377-2787)**. To find your local service office, visit www.DaikinApplied.com or call **800-432-1342**. This document contains the most current product information as of this printing. For the most up-to-date product information, please go to www.DaikinApplied.com.

Products manufactured in an ISO certified facility.



www.DaikinApplied.com