



Catalog 1113-18

SmartSource® Single Stage Horizontal & Vertical Water Source Heat Pumps

GSH - Horizontal Ceiling

GSV - Vertical Floor

Unit Sizes 007 – 070 • R-410A Refrigerant

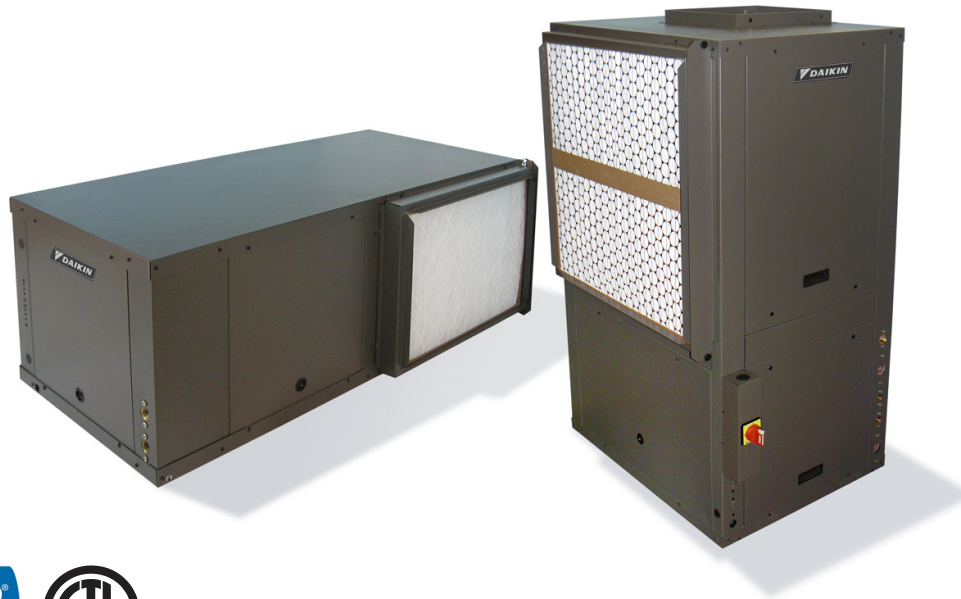

Model Nomenclature	3	Ductwork and Attenuation	22
AHRI Performance Data	5	Piping	24
Introduction	6	Water System Quality	25
SmartSource® Single Stage Horizontal & Vertical Water Source Heat Pumps	6	Condensate Drain	26
SmartSource Unique Features	7	Operating Limits	26
Model GSH-Horizontal & GSV-Vertical Unit	7	Air Limits	26
Hot Gas Reheat Coil	8	Fluid Limits	26
Hydronic Heat	8	Unit Selection	27
Desuperheater	9	Capacity Data	30
Loop Pump(s)	9	Size 007 (250 CFM)	30
Waterside Economizer	9	Size 009 (300 CFM)	32
Electric Heat (internal or external)	10	Size 012 (400 CFM)	34
Designed-in Sound Reduction	10	Size 015 (500 CFM)	36
Cabinet	11	Size 019 (600 CFM)	38
Unit Configurations	11	Size 024 (800 CFM)	40
Field Adjustable EC Fan Motor	12	Size 030 (1000 CFM)	42
Compressors - Double Isolated	12	Size 036 (1250 CFM)	44
Service Connections	12	Size 042 (1400 CFM)	46
Water Connections	12	Size 048 (1600 CFM)	48
2-Way Motorized Water Valve	12	Size 060 (2000 CFM)	50
Horizontal Unit Hanger Bracket	12	Size 070 (2160 CFM)	52
Stainless Steel Drain Pan	12	Performance Data	54
Air-to-Refrigerant Coil	13	Fan Performance – Constant Torque EC Motor	54
Refrigeration System	13	Fan Performance – Constant CFM Type EC Motor	55
Blower Section	13	Jumper Settings on I/O Expansion Module	56
Disconnect Switch (Option)	13	Air Flow Correction Factors	57
Water Pressure Differential Switch (Option)	13	Loop Pump Performance	58
Filter & Filter Rack	13	Desuperheater Performance	58
Unit Control	14	Electric Heat Performance	58
MicroTech® III SmartSource Unit Controller & I/O Expansion Module	14	Waterside Economizer Cooling Capacity - Vertical Unit	59
Built-in Diagnostics	14	Waterside Economizer Cooling Capacity - Horizontal Unit	60
Fan Speed Selector Switch	14	Hydronic Coil Performance	61
Jumper Settings on I/O Expansion Module	15	Electrical Data	63
Variable CFM	15	Correction Factors	64
MicroTech® III SmartSource Controller with LONWORKS® Communication Module	15	Motorized 2-Way Water Valve	64
MicroTech III SmartSource Controller with BACnet® Communication Module	16	Antifreeze	64
Accessories	17	Physical Data	65
Hoses, Hose Kits and Shutoff Ball Valves for SmartSource Water Source Heat Pumps	17	Vertical Units	65
Shutoff Ball Valves with Memory Stop	17	Horizontal Units	66
2 & 3-Way Motorized Water Valves	17	Dimensional Data	68
Supply and Return Hose Kits	17	Horizontal Unit – Size 007, 009 & 012	68
Condensate Hose Kits	18	Horizontal Unit – Sizes 015 through 070	70
Electric Duct Heaters (Horizontal Units)	18	Vertical Unit	72
Filters	18	Thermostats and Remote Indoor Sensor	74
Loop Circulating Pump Modules	19	Room Temperature Sensors	75
Applications	21	Engineering Guide Specifications	76
Typical Vertical Installation	21	Horizontal Unit	76
Typical Horizontal Installation	22	Vertical Unit	82
		Appendix-A	87
		Appendix-B	87
		Appendix-C	87

Note: Text displayed in ***Bold-Italics*** designate standard offering.

Category	Code Item	Code Option	Code Designation & Description (<i>Bold-Italic = Standard</i>)
Product Category	1	1	<i>W</i> = <i>Water Source Heat Pump</i>
Model Type	2	2-3	<i>GS</i> = <i>High Efficiency Single Stage</i>
Configuration	3	4	<i>H</i> = <i>Horizontal</i> <i>V</i> = <i>Vertical</i>
Nominal Capacity	4	5-7	007 = 7,000 Btuh Nominal Cooling 009 = 9,000 Btuh Nominal Cooling 012 = 12,000 Btuh Nominal Cooling 015 = 15,000 Btuh Nominal Cooling 019 = 19,000 Btuh Nominal Cooling 024 = 24,000 Btuh Nominal Cooling 030 = 30,000 Btuh Nominal Cooling 036 = 36,000 Btuh Nominal Cooling 042 = 42,000 Btuh Nominal Cooling 048 = 48,000 Btuh Nominal Cooling 060 = 60,000 Btuh Nominal Cooling 070 = 70,000 Btuh Nominal Cooling
Unit Control	5	8	<i>B</i> = <i>MicroTech III SmartSource unit controller</i>
Design Series (Vintage)	6	9	1 = Revision / Design Series 1
Voltage	7	10	A = 115/60/1 <i>E</i> = <i>208-230/60/1</i> F = 208-230/60/3 J = 265/60/1 K = 460/60/3
Range for Entering Water/Glycol Temp.	8	11-12	GW = Ground Water <i>WL</i> = <i>Water Loop</i> GL = Ground Loop
Return Air Location	9	13	L = Left-Hand Return Air & Right-Hand Piping <i>R</i> = <i>Right-Hand Return Air & Right-Hand Piping</i>
Discharge Air Location	10	14	E = End (Horizontal Unit Only) <i>T</i> = <i>Top (Vertical Unit Only)</i> <i>S</i> = <i>Straight (Horizontal Unit Only)</i>
Fan Motor	11	15	<i>4</i> = <i>ECM Constant CFM</i> 5 = ECM Constant Torque
Dehumidification Option	12	16	B = Hot Gas Reheat Smart Dehumidification (Unit Sizes 007, 009, 015-070) C = Simplified Dehumidification (Lower CFM no HGRH or no Humidistat) D = Humidistat Controlled Dehumidification (No HGRH) E = Humidistat Only <i>Y</i> = <i>None</i>
Sound Package	13	17	<i>Y</i> = <i>None</i> A = Premium
Coaxial Heat Exchanger Construction (Supply Liquid / Refrigerant)	15	19	<i>C</i> = <i>Copper Inner Tube - Steel Outer Tube</i> S = Cupronickel Inner Tube - Steel Outer Tube
Primary Air Coil Option	16	20	<i>S</i> = <i>Standard</i> C = Corrosion Protection
Communication Module	19	24	B = BACnet L = LonWORKS <i>Y</i> = <i>None</i>
Filter Rack	20	25	<i>2</i> = <i>4-Sided, 2" w/Duct Collar & Door</i> 3 = 4-Sided, 2" w/Duct Collar, Door, Hi-Merv Seal 4 = 4-Sided, 4" w/Duct Collar, Door, Hi-Merv Seal Y = None
Filter Type	21	26	<i>A</i> = <i>Disposable</i> E = Merv 8 Factory-Installed G = Merv 13 (4-inch thick) Factory-Installed Y = None
Water Coil - Indoor Air	22	27	E = Waterside Economizer H = Hydronic Heat <i>Y</i> = <i>None</i>
Electric Heating - Indoor Air	23	28	C = 5.0 kW Internal Electric Heater E = 10.0 kW Internal Electric Heater F = 15.0 kW Internal Two Stage Electric Heater G = 20.0 kW Internal Two Stage Electric Heater P = Control for Electric Heat, Single 24V Signal (Field-installed Duct Heater by others) <i>Y</i> = <i>None</i>

Category	Code Item	Code Option	Code Designation & Description (<i>Bold-Italic = Standard</i>)
Control Secondary Heat Type	24	29	B = Boilerless Electric Heat E = Emergency Electric Heat P = Primary Electric Heat (No Heat Pump Heating) S = Supplemental Heat Y = None
Desuperheater (Hot Water Generator)	25	30	D = Desuperheater Y = None
Loop Pump	26	31-32	1S = One Low Head Pump 1L = One High Head Pump 2S = Two Low Head Pumps 2L = Two High Head Pumps YY = None
Coaxial Coil Supply Liquid Flow Control	27	33	B = 2-Way, Motorized - 24v Valve Control, NO Y = None
Coaxial Coil Supply Liquid Auto Flow Reg	28	34	A = Auto Flow Control 1.5 GPM B = Auto Flow Control 2.0 GPM C = Auto Flow Control 2.5 GPM D = Auto Flow Control 3.0 GPM E = Auto Flow Control 4.0 GPM G = Auto Flow Control 5.0 GPM H = Auto Flow Control 6.0 GPM I = Auto Flow Control 8.0 GPM J = Auto Flow Control 9.0 GPM K = Auto Flow Control 10.0 GPM L = Auto Flow Control 11.0 GPM M = Auto Flow Control 12.0 GPM N = Auto Flow Control 13.0 GPM P = Auto Flow Control 15.0 GPM S = Auto Flow Control 18.0 GPM Y = None
Water Pressure Differential Switch	30	36	D = Water Pressure Differential Switch Y = None
Desuperheater Water Flow Options	31	37	Q = Pump - 208-230/60/1 Voltage Y = None
Water Coil Piping Package Options (Hot Water or Waterside Economizer)	35	41	A = 3-Way Motorized - 24V Valve Control, NO to Coax
Primary Drain Pan Material	39	45	S - Stainless Steel
Compressor Insulation	41	47	B = Compressor Insulation Sound Blanket Y = None
Compressor Isolation	42	48	B = Isolated base
Unit Cabinet Insulation	43	49	S = 1/2" Fiberglass Skin-Face in Compressor Section, 1/2" Fiberglass Foil-Face Insulation in Airside Section I = Indoor Air Quality Insulation Package - 3/8" Closed Cell Foam in Compressor Section, 3/8" Closed Cell Foam Insulation in Airside Section R = Sound Reduction Package - 3/4" Sound Insulation in Compressor Section and Air Section (Unit Sizes 007 - 019)* 1/2" Fiberglass Skin-Face in Compressor Section with Compressor Sound Blanket, 3/4" Sound Insulation in Airside Section (Unit Sizes 024 - 070)
Note: *Compressor sound blanket is not recommended on a unit with a rotary compressor			
Insulation - Piping	45	51	A = Insulated Piping Y = None
Cabinet Finish	47	53	A = Powder Coat Y = None
Cabinet Color	48	54	Y = None W = Off White T = Textured Charcoal Bronze
Fan Motor Control	50	56	C = Various Speeds with 4 Adjustment Settings
Disconnect Switch	53	60	Y = None N = Non-Fused
Control Transformer	55	62	1 = 50VA Control Transformer 2 = 75VA Control Transformer
Thermostat/Sensor Control	56	63	T = Thermostat Control S = Sensor Control
Expansion Device	75	82	A = Thermal Expansion Valve Thermal Bulb and Equalizer Tube
Alarm Relay	76	83	A = Alarm Relay (Dry Contacts) Y = None

©2024 Daikin Applied, Minneapolis, MN. All rights reserved throughout the world. This document contains the most current product information as of this printing. Daikin Applied Americas Inc. has the right to change the information, design, and construction of the product represented within the document without prior notice. For the most up-to-date product information, please go to www.DaikinApplied.com.

™ SmartSource, MicroTech, and Daikin Applied are trademarks or registered trademarks of Daikin Applied Americas Inc. The following are trademarks or registered trademarks of their respective companies: BACnet from American Society of Heating, Refrigerating and Air-Conditioning Engineers, Inc.; Echelon, LonWorks, LonMark, and LonTalk from Echelon Corporation; Modbus from Schneider Electric; and Windows from Microsoft Corporation.

Note: Rated in accordance with AHRI/ASHRAE/ISO Standard 13256-1.

Unit Size	GPM	Cooling			Heating		
		CFM	Total Cap.	EER	CFM	Tot Cap.	COP
Water Loop							
007	2.2	250	8000	15.4	250	9800	5.5
009	2.4	300	9700	15.6	300	12000	4.8
012	3.3	400	12700	15.5	400	15700	5.4
015	3.8	500	15300	18.1	500	19100	5.9
019	4.4	600	17500	15.7	600	22600	5.7
024	6.5	800	26200	16.9	800	28900	6.0
030	7.5	1000	30000	17.3	1000	33600	5.8
036	9.0	1250	37300	19.2	1250	40800	6.0
042	10.5	1400	43900	17.5	1400	48600	5.4
048	12.2	1600	50500	17.2	1600	57100	5.4
060	16.0	2000	63700	17.4	2000	74200	5.2
070	17.5	2160	73400	15.9	2160	89000	5.0
Ground Loop							
007	2.2	250	8400	18.1	250	6200	3.9
009	2.4	300	10200	15.0	300	7500	3.3
012	3.3	400	13300	18.1	400	10000	3.9
015	3.8	500	16000	21.2	500	11700	4.1
019	4.4	600	18700	18.7	600	13800	4.1
024	6.5	800	27500	19.9	800	17700	4.1
030	7.5	1000	31300	20.1	1000	21600	4.1
036	9.0	1250	38500	22.0	1250	26200	4.3
042	10.5	1400	45500	20.2	1400	31300	4.0
048	12.2	1600	52700	19.9	1600	36900	4.0
060	16.0	2000	66300	20.0	2000	46500	3.8
070	17.5	2160	75700	18.0	2160	55800	3.7

Legend: COP = Coefficient of Performance
GPM = Gallons per Minute

CFM = Airflow Rate, Cubic Feet per Minute
EER = Energy Efficiency Ratio

Water Loop: 1. Cooling capacity is based on 80.6°F db, 66.2°F wb (27/19°C) EAT and 86°F (30°C) EWT.
2. Heating capacity is based on 68°F db, 59.0°F wb (20/15°C) EAT and 68°F (20°C) EWT.

Ground Loop: 1. Cooling capacity is based on 80.6°F db, 66.2°F wb (27/19°C) EAT and 77°F (25°C).
2. Heating capacity is based on 68°F db, 59.0°F wb (20/15°C) EAT and 32°F (0°C).

SmartSource® Single Stage Horizontal & Vertical Water Source Heat Pumps

Industry Leading Efficiencies, Very Quiet Operation



SmartSource water source heat pumps from Daikin combine industry-leading efficiencies with low-noise operation, high indoor air quality and consistent air temperatures. So now you can do your part to conserve energy and enjoy a quiet and comfortable indoor environment.

Very quiet

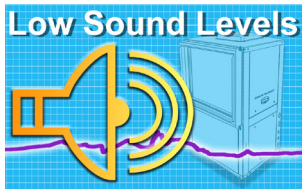

SmartSource water source heat pumps are exceptionally quiet, with published sound ratings as low as 46 dBA. Sound reduction packages are available for even greater attenuation. These units

typically operate at low compressor and fan speeds a majority of the time. The result is even quieter operation, very low energy consumption and very uniform room air temperatures.

EC motors are standard on all units, with field-selectable CFM settings. EC motors are more efficient than traditional PSC motors, which is why most utilities offer rebates for their use. EC motors also provide near-constant fan speeds at static pressures up to one inch. The result is improved air filtration capabilities and more uniform air distribution.

Durable construction

Cabinets on all units feature a rugged, texturized, powder-coat paint finish for exceptional durability. Slotted handles make it easy to remove panels for maintenance and service. Cleanable, foil-faced fiberglass insulation is standard in the air-handling section to minimize sound transmission while preventing fibers in the air stream. High-IAQ options include 3/8-inch, closed-cell insulation in both the compressor and air-handling sections.

Wide range of options



Available options on all units include auxiliary electric heat in both internal (vertical units only) and external configurations. MERV 8 and 13 filters are available, with standard 2 inch filter rack or an optional 4 inch filter rack that accept a two-inch or four-inch cartridge. A desuperheater option takes advantage of

waste heat from the compressor to provide domestic hot water, ideal for apartments and condos. Also available is a waterside economizer to minimize mechanical cooling by using cool loop water to condition the space. A hydronic heat option is available to utilize hot loop water temperatures for heating and minimize mechanical heating.

Several methods of dehumidification options are available, including hot gas reheat. For geothermal applications, a unit-mounted loop pump option reduces system complexity by eliminating the need for a central pumping system.

Typical applications for SmartSource water source heat pumps include schools, clinics, office buildings, government offices, senior living facilities and other projects, both new construction and retrofit, where high efficiency is a key specification.

Model GSH-Horizontal & GSV-Vertical Unit



1 EC fan motor:

- 4 field adjustable fan settings and up to 7 operating mode options, provide a wide range of airflow selection (up to 28) for quieter operation and lower energy consumption.

2 High efficiency scroll or rotary compressor:

- available in a variety of commercial voltages, mounted on a double isolation system for reduced sound and vibration.

3 Refrigerant circuit:

- Utilizes R-410A refrigerant with a bi-flow thermal expansion valve for easy metering and four way solenoid reversing valve.

4 MicroTech® III, SmartSource controls:

- Easy open-protocol integration with optional LONWORKS® or BACnet®.

5 Unit status LED:

- Instant visuals on unit operation for easy troubleshooting and advanced diagnostics.

6 4-sides filter rack with standard 2" or optional 4" filters:

- Designed for easy filter maintenance.
- MERV 8 & 13 filter options with gasketed filter rack meet LEED-NC EQc5 applications with leakage rate at less than 4 CFM per square foot of filter area at 0.5" ESP.

7 Stainless steel drain plan:

- Sloped with lipless drain connection for positive condensate flow, meets ASHRAE 62.1 Section 5.11.

8 Flush mounted fittings:

- Easy one wrench connection, securely fastened to the cabinet corner posts.

9 Blower and motor orifice ring:

- Easy service removal without having to remove the blower housing or disconnecting the unit from the duct work.

10 Durable cabinet construction:

- Heavy gauge steel, available with an optional powder coated textured paint, (charcoal bronze), and lined with cleanable foil-faced insulation on the airside.

Four Unique Dehumidification Options:

- **Smart Dehumidification** – Uses hot gas reheat, humidistat, 1-stage thermostat & smart air flow management for precise humidity control. Available on unit sizes 007, 009, and 015 through 070.
- **Simplified Dehumidification** – Uses a 2-stage thermostat to optimize unit capacity and fan speed for maximum latent capacity while decreasing room humidity levels.
- **Humidistat Controlled Dehumidification** – Uses a humidistat and 1-stage thermostat to control room humidity levels.
- **Dehumidification Only** – Uses a humidistat in cooling only mode.

Hot Gas Reheat Coil

For improved indoor climate control, Daikin Applied offers accurate and cost effective dehumidification control using a hot gas reheat option known as smart dehumidification. Hot gas reheat with smart dehumidification is an excellent solution for applications where maintaining low humidity in a space is crucial. With smart dehumidification, once the space temperature is satisfied, the humidistat signal diverts the high temperature refrigerant gas to the reheat coil located downstream of the cooling coil. The conditioned and reheated air prevents over cooling of the space and maximizes moisture removal for improved indoor comfort. The smart ECM fan system adjusts the air flow for optimal moisture removal, and helps keep sound levels at a minimum. It is especially effective during low load conditions when proper control is critical. Under humid conditions (60%RH) and typical loop water temperatures, the latent capacity is optimized for approximately 90% of the sensible capacity.

With loop water conditions of 85°F, the leaving air temperature is approximately the same as the entering air temperature, resulting in effective dehumidification without over cooling the space.

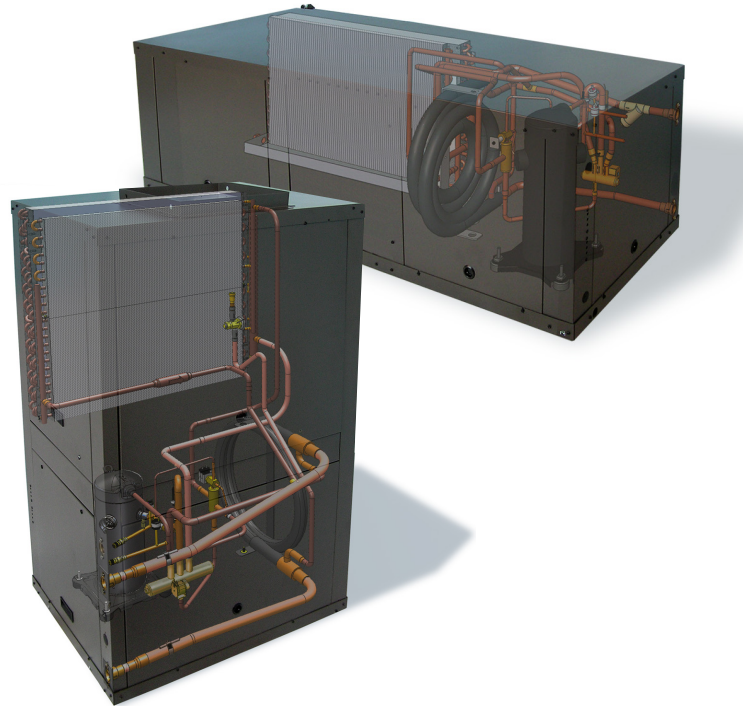

Hydronic Heat

The hydronic heat option helps to reduce energy consumption by using hot loop water temperatures to condition a space without energizing mechanical heating. Hydronic heat can help maximize heat transfer from rooms that require cooling to ones that require heating without the added cost of operating the compressor.

Variable flow pumping systems are recommended for these systems to further reduce energy consumption, while maintaining sufficient water flow during heating operation.

The unit includes a hydronic heating coil located downstream of the unit's evaporator coil and after the filter. When entering water temperatures are between 70° to 120°F, a 3-stage thermostat or room temperature sensor in conjunction with a factory-installed entering water temperature sensor and a 2-position 3-way diverting valve, determine when loop water can be diverted to the hydronic coil and the unit coax coil for hydronic heating. Smart fan controls further reduce energy consumption and sound levels by delivering optimum air flow during hydronic heat operation.

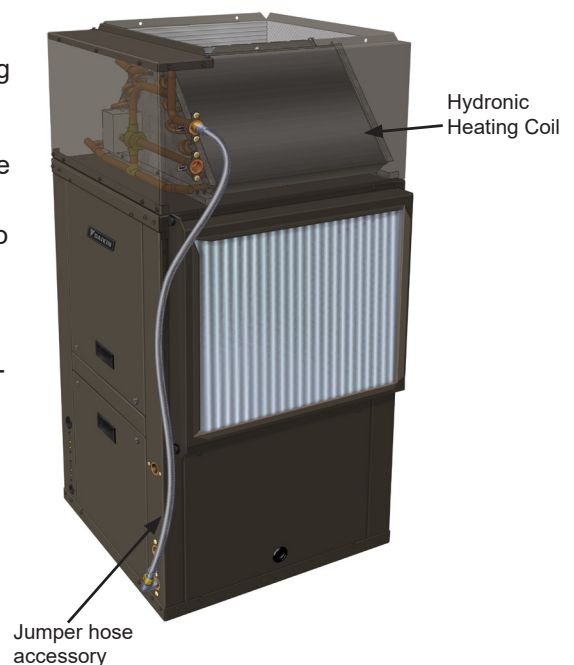

Desuperheater

The factory-installed desuperheater option saves energy by using heat that would otherwise be “wasted” to the water loop, and uses it to supplement the heating of domestic water. The desuperheater has a double-wall, vented coaxial heat exchanger, an optional water pump for 208/230- 1 and 3-phase applications, with controls to temper the make-up water.

Controls include a refrigerant discharge line thermostat, an Entering Water Temperature (EWT) thermostat and an “on-off” switch located on the outside of the unit cabinet to deactivate the desuperheater system during the heating mode.

This option is available on vertical units sizes 2 tons and larger.

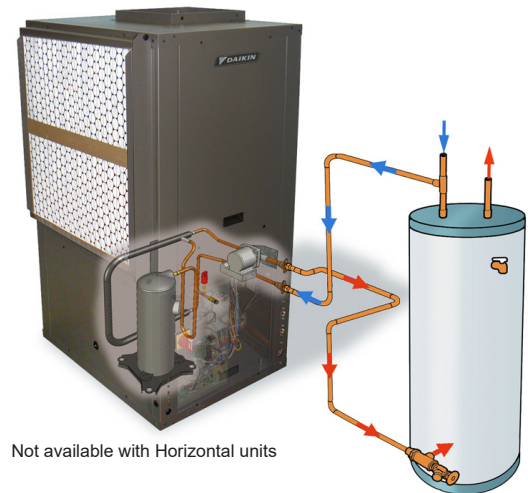

Loop Pump(s)

Unit-mounted loop pump(s), available on horizontal and vertical unit sizes 2 tons and larger, eliminate the need for a central pumping station. Several loop pump options are available to match the system flow and head requirements for most geothermal and water loop applications. Sized for approximately 3 GPM/ton, both low and high head options are available in a single or dual (series flow) configuration. The series configuration essentially doubles the head capabilities. A factory supplied transformer is provided for single-point power supply.

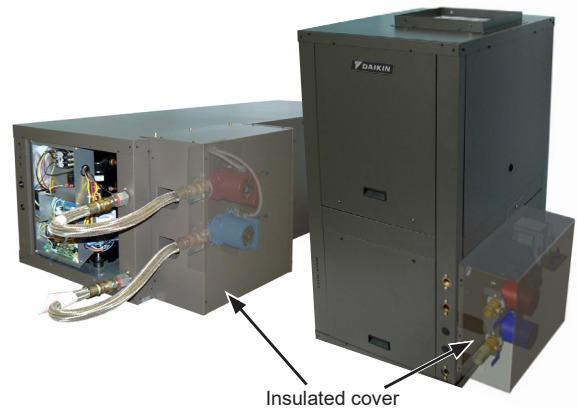

Waterside Economizer

The waterside economizer option helps to reduce energy consumption by using cool loop water temperatures to condition a space without energizing mechanical cooling. Even in the coldest weather a space can experience a build-up of ambient heat from people, equipment, lighting and the sun. Buildings with temperature controlled computer rooms, media/resource rooms or medical equipment rooms, benefit from the waterside economizer when the geothermal loop field or cooling tower temperatures are cool enough to provide air conditioning.

Variable flow pumping systems are recommended for these systems to further reduce energy consumption, while maintaining sufficient water flow during economizer operation.

The waterside economizer includes a hydronic cooling coil located upstream of the unit's evaporator coil and after the filter. When entering water temperatures are between 70° to 50°F, a 3-stage thermostat or room temperature sensor in conjunction with a factory-installed entering water temperature sensor and a 2-position 3-way diverting valve, determine when loop water can be diverted to the hydronic coil and the unit coax coil for economizer cooling. Smart fan controls further reduce energy consumption and sound levels by delivering optimum air flow during economizer operation. The MicroTech III SmartSource controller determines if the economizer and mechanical cooling can be activated together, while optimizing unit airflow. The controller also provides low temperature protection to avoid economizer operation when entering water temperatures are below 35°F.

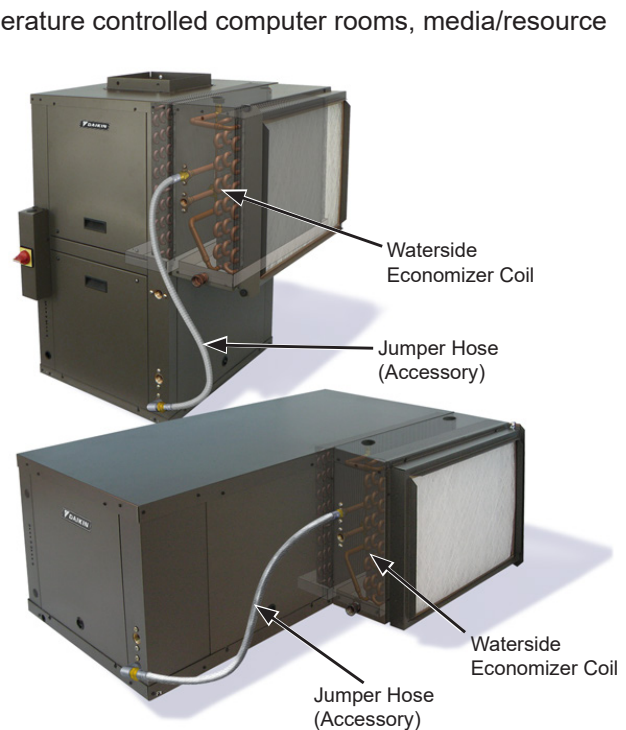

Electric Heat (internal or external)

Factory installed electric heaters are available on vertical units. These heaters are located above the blower housing inside the discharge air plenum. Horizontal units utilize an external duct-mounted electric heater for field-installation. Unit controls are available for boilerless, supplemental, primary or emergency electric heat to serve several different application needs. Boilerless electric heat will be energized when the entering water temperature falls below set point. This will allow electric heat to function while ensuring the compressor remains off. With supplemental electric heat control, the wall thermostat will activate the compressor and heater simultaneously if necessary to maintain room heating conditions. For primary heat applications, only the electric heater will provide heat without energizing the compressor. Emergency heat is activated by a 24V thermostat signal to energize the external duct-mounted electric heat. For available electric heat sizes and voltages see "[Model Nomenclature](#)" on page 3, "[Product Code Index](#)", code item "23".



Horizontal unit external duct-mounted electric heater

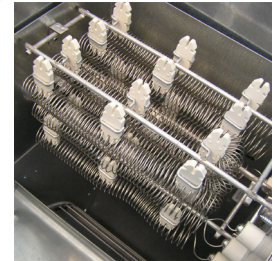

Vertical unit internal factory-installed electric heater

Designed-in Sound Reduction

Provided as standard, the compressor mount has a unique dual-level vibration isolation system. The compressor is mounted on vibration isolation grommets to a heavy gauge mounting plate, then isolated from the cabinet base with rubber grommets to minimize vibration transfer. The compressor is equipped with thermal overload protection and is located in a well-insulated compartment away from the air stream to minimize sound transmission. All access panels have acoustic seals to eliminate panel vibration and minimize radiated sound levels. Fan noise can be minimized at low airflow with field adjustable EC fan motor settings. An optional sound reduction kit adds a 3/4" thick acoustic foam panel of insulation to the fan section and a compressor blanket (unit sizes 024 to 070 only) to help further reduce operating sound levels.



Cabinet

The SmartSource vertical floor and horizontal ceiling cabinet comes with a standard rugged, textured- non-glare, powder-coat charcoal bronze paint. All cabinetry is fabricated from heavy gauge G-60 galvanized sheet metal.

The vertical floor unit offers two cabinet configurations with 6 unique cabinet sizes that make up the 1/2 through 6 ton vertical heat pump product line. For maximum flexibility, each vertical unit is available in either a left-hand or right-hand return air arrangement to provide the optimum piping location and service access. The mirror image design of the units allow for configuring the system using minimum ductwork and piping. This helps reduce design, material and installation costs.

Horizontal ceiling mounted units offer 6 cabinet sizes in four unique cabinet configurations with the smallest possible footprint, allowing for optimum design flexibility. Ceiling mounted units ship with heavy metal brackets, rubber isolators, fasteners and washers to suspend and isolate the unit from the building.

Cabinet Insulation

Premium type insulation is provided standard with all SmartSource horizontal and vertical unit cabinets providing a high level of indoor air quality. As a standard the compressor compartment surfaces are lined with 1/2" fiberglass skin-face type insulation. Separated from the compressor section by a partition, the airside/blower section comes standard with 1/2" thick fiberglass cleanable foil face insulation to prevent introduction of fibers into the discharge air stream, providing maximum sound attenuation. The standard cabinet insulation meets NFPA 90A requirements, air erosion and mold growth limits of UL-181, fungal resistance test per ASTM-C1071 and ASTM G21, and meets zero level bacteria growth per ASTM G22. All insulation has a flame spread of less than 25 and a smoke developed classification of less than 50 per ASTM E-84 and UL 723.

Optional insulation is available in 3/8" thick closed-cell non fibrous insulation for Indoor Air Quality (IAQ).

A sound reduction package is available in 3/4" thick insulation as a factory installed option. Unit sizes 024 - 070 utilize a sound attenuating compressor blanket, combined with high technology sound material applied within the air handling compartment to further reduce sound transmitted by the unit. Unit sizes 007 - 019 have sound attenuating material in the compressor compartment in lieu of a compressor sound blanket. A compressor sound blanket is not recommended on a unit with a rotary compressor.

Unit Configurations

Figure 1: Two vertical unit configurations

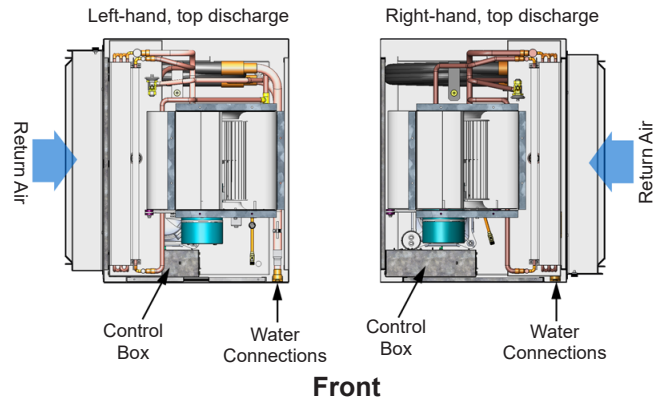
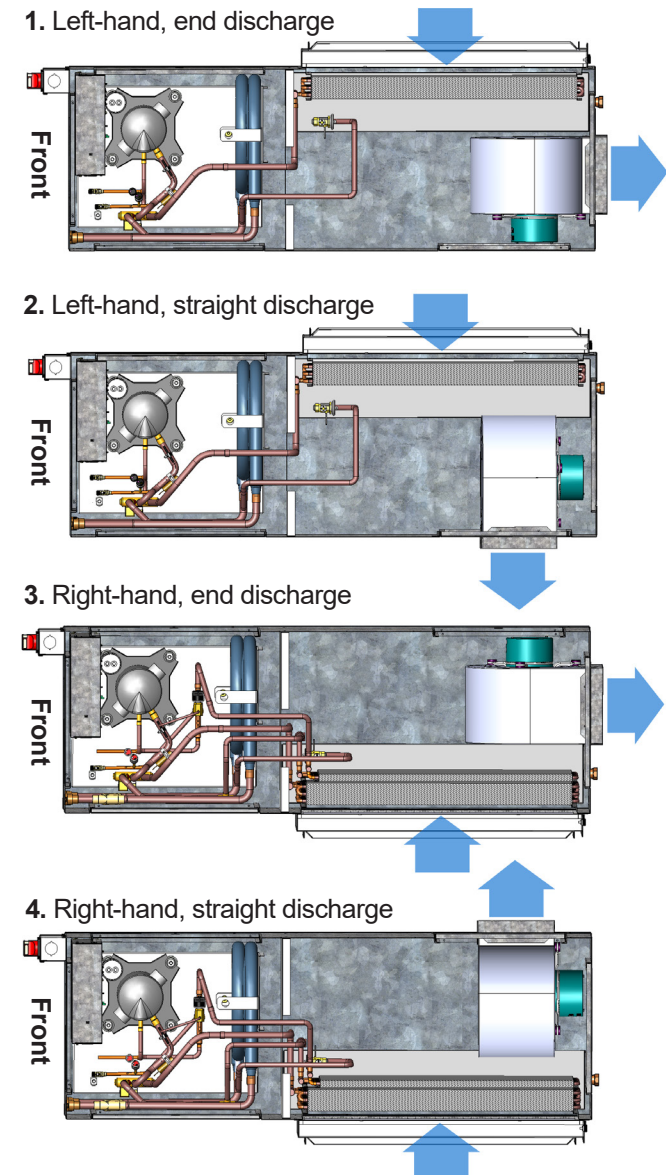

Figure 2: Four horizontal unit configurations



Note: Unit left or right hand is determined by facing the piping connection (front) side of unit

Field Adjustable EC Fan Motor

EC motors are standard on all units, with 4 field-selectable CFM settings and 28 programmed CFM values. EC motors provide the ultimate in efficiency, performance flexibility and reduced sound levels. With inherent high efficiencies compared to conventional PSC or fix speed motors, the EC motor can save operating energy. The factory installed rotary fan speed selection switch allows for easy commissioning through a simple click of the switch to set the CFM delivered to the space. This allows for field adjustment of air delivery to the space for sound sensitive applications or for increased air distribution.



Compressors - Double Isolated

The scroll compressor provides excellent performance and increased efficiency. The compressor has a unique dual-level vibration isolation system. Mounted on vibration isolation grommets to a heavy gauge compressor mounting plate, then isolated from the cabinet base with rubber grommets to minimize vibration transfer. The compressor is equipped with thermal overload protection and is located in an insulated compartment away from the air stream to minimize sound transmission.



Service Connections

Two service valves are located inside the end access panel – one on the low side and one on the high side of the refrigeration circuit – for charging and servicing. All valves are 7/16" SAE fittings.



Water Connections

The water and condensate connections are FPT fittings, securely mounted flush to the corner post to allow for connection to a flexible hose without the use of a back-up wrench. This helps reduce the time required to connect the unit and helps prevent delays due to shipping damage. All vertical units are internally trapped with clear vinyl tubing, to allow inspection of condensate drain.



2-Way Motorized Water Valve

The optional 2-way valve is used for variable pumping applications when more than one unit is installed on a common loop. These valves are also used to conserve water when used for ground water applications.



Horizontal Unit Hanger Bracket

Each horizontal unit is furnished with a mounting kit that includes heavy metal hanger brackets for hanging the unit from field-supplied hanger rods. Rubber isolators are included for sound and vibration attenuation, as are mounting washers, bolts and lock washers. The hangers are attached to fasteners at each corner of the unit, which are an integral part of the cabinet.



Standard hanger bracket
for unit sizes 007-019

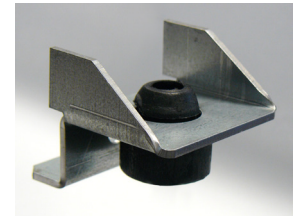

Heavy-duty hanger bracket
for sizes 024-070

Stainless Steel Drain Pan

The condensate drain pan is constructed of corrosion-resistant stainless steel. It is wrapped in closed-cell insulation, double-sloped with a "lipless", free-draining pipe connection for positive drainage and an internal trap for improved Indoor Environmental Quality (IEQ) that meets ASHRAE 62.1-2007 Section 5.11. The drain pan is provided with solid-state electronic condensate overflow protection, unlike the less reliable mechanical float switch used with many competitor drain pans. The horizontal unit condensate drain pan is sloped, allowing for the unit to be mounted level in the ceiling, without tilting the unit to encourage drainage as some competitor units require.

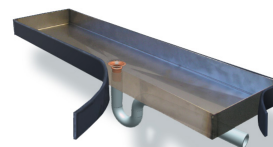

Vertical unit drain pan



Horizontal unit drain pan

Air-to-Refrigerant Coil

The air-to-refrigerant heat exchanger is a large face area coil with copper tubes and aluminum fins. The fins are lanced and mechanically bonded to the tubes using finned edges on the inside which expand during assembly to enhance heat transfer capabilities. The maximum working pressure of the heat exchanger is 600 psig (4137 kPa). The coil is designed for optimal performance in both heating and cooling while maintaining the benefit of a compact size. The coils can be coated with an optional inorganic, silicon-based nano-ceramic coating. This coating has a 3,000 hour salt spray rating per ASTM B117.

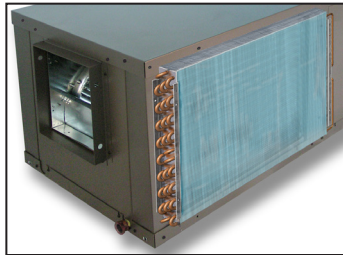

Refrigeration System

Units have a coaxial heat exchanger with a copper inner tube and a steel outer tube. The air coil is a large face area coil with copper tubes and aluminum fins. Safety controls include a 600 psi high-pressure switch and low-temperature sensor to lock out compressor operation at extreme conditions. For additional protection, a 7 psi (48 kPa) low-pressure switch to protect the compressor from low refrigerant charge. The low setting prevents nuisance trips while providing additional protection.



Blower Section

The blower section includes the EC motor, a direct-drive centrifugal fan, fan housing, and drain pan. A duct collar protrudes through the cabinet to facilitate field-supplied duct connection. The large size of the blower wheel allows it to rotate more slowly, reducing motor work to improve efficiency and provide for quiet operation. A large panel provides service access to the blower and motor. All blower/motor assemblies have a removable orifice ring on the housing to accommodate motor and blower removal without disconnecting the unit from the ductwork.

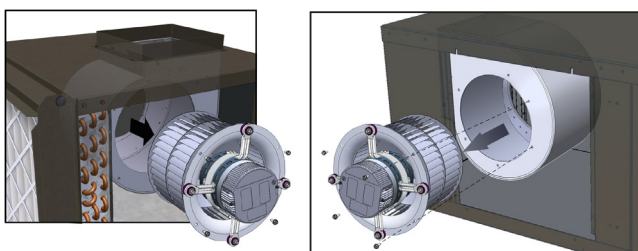

Disconnect Switch (Option)

SmartSource units are available with an optional non-fused disconnect switch, located on the unit front corner post. The disconnect switch is used to break power to the unit for ease of field service and is provided with a lockout/tag out feature.



Water Pressure Differential Switch (Option)

The water pressure differential switch monitors water pressure drop across the heat exchanger. Selectable as a factory mounted option it is internal to the cabinet and will disable compressor operation if flow is not detected.

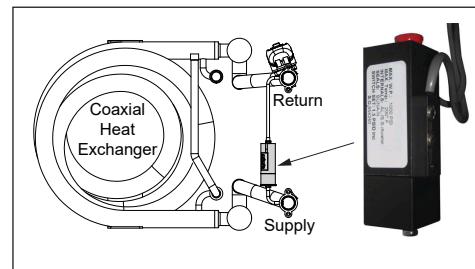

Filter & Filter Rack

Units come standard with a 2" (51mm) thick factory-installed throwaway filter, mounted in a 4-sided combination filter rack and return air duct collar. Filters can be easily removed from either side by interchanging the removable filter door to the right or left side by rotating the filter rack assembly 180 degrees. A 2" or 4" filter rack is available as a factory-installed selectable option to accept a Merv 8 or Merv 13 filter. The high Merv filter rack option is available with gaskets between it and the cabinet and along the edge of the tool-less removable door. The gaskets maintain the leakage rate below 4 CFM per square foot of filter area at .5" ESP.

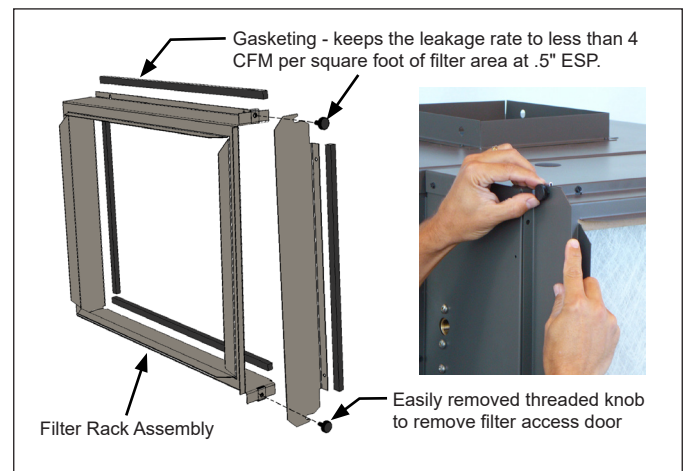

MicroTech® III SmartSource Unit Controller & I/O Expansion Module

The MicroTech III SmartSource controller is a microprocessor-based control board in combination with an I/O Expansion Module for extra functionality. The control box is accessible through the left or right end corner panel on horizontal units and through the bottom-front access panel on the vertical unit. The unit controller is a hard wired interface and in combination with the I/O Expansion Module provides all the necessary field connections and functionality. All components are easily accessed for service or replacement.

Figure 3: MicroTech III SmartSource unit controller and I/O expansion module

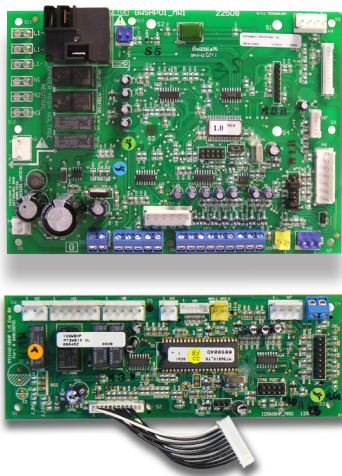

Three control choices are offered with the MicroTech III SmartSource unit control system:

- MicroTech III SmartSource unit controller with I/O Expansion Module
- MicroTech III SmartSource unit controller with I/O expansion module and a LONWORKS® communication module
- MicroTech III SmartSource unit controller with I/O expansion module and a BACnet® communication module

Each option features direct quick-connect wiring to all unit-controlled components for “clean” wiring inside the control box. Each control circuit board receives power from a 50 VA or optional 75 VA transformer. The main board can be wired for 24-volt AC output to the wall thermostat by using terminals R & C.

Built-in Diagnostics

External LED annunciators are located on the front corner of the unit chassis to quickly check the operating status of the unit. The I/O Expansion Module has an independent LED annunciator to identify operational fault conditions.

Figure 4: External LED annunciators

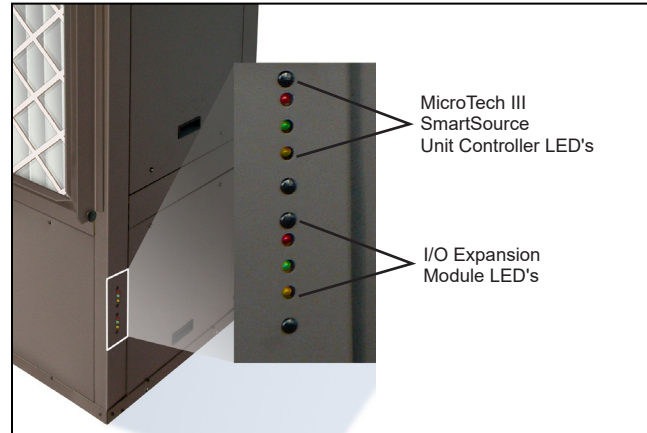

Fan Speed Selector Switch

A 4-position fan speed selector switch located in the control box allows CFM settings to be field adjustable. Fan speed control optimizes unit fan speed based on thermostat/room sensor inputs. The fan speed switch allows for manually setting an optimal fan speed specific to the application requirements. Each position on the fan speed switch represents settings 1-4. See Table 1 below and Table 11 on page 55 for a complete list of fan speed selector switch settings.

Figure 5: 4-position fan speed selector switch

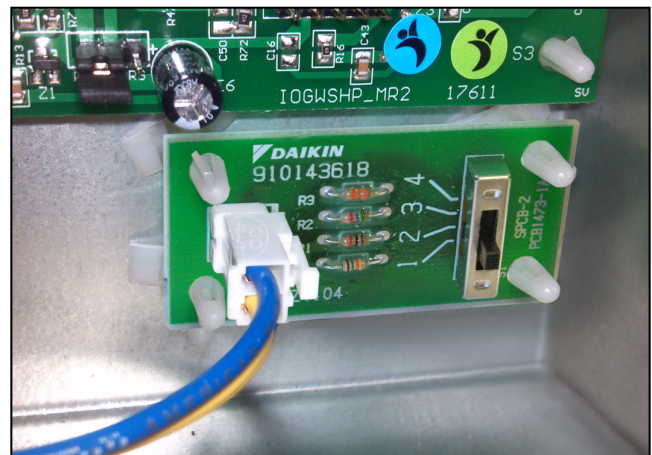

Table 1: Fan speed selector switch settings (2-ton unit example)

CFM Setting	Stage 1 Heat	Stage 2 Heat	Stage 1 Cool	Stage 2 Cool	Dehumidification	Electric Heat
Setting 4 (High)	800	900	800	900	650	900
Setting 3 (Standard)	700	800	700	800	650	900
Setting 2 (Medium)	600	700	600	700	600	900
Setting 1 (Low)	600	600	600	600	600	900

Jumper Settings on I/O Expansion Module

In addition to the 4-position switch, all units have the capability to set CFM values independent to those associated with compressor operation. Independent CFM values can be set for fan only, dehumidification, water-side economizer and hydronic heat from the jumper pins JP1 and JP2 on the I/O expansion module. The jumper pin configurations represent settings A, B, C and D. See [Table 12 on page 56](#). These settings establish unique CFM settings for the four previously mentioned modes of operation. See [Table 11 on page 55](#) under the I/O Expansion Module. For example, unit size 036 with the 4-position switch set at Setting #3 and the I/O expansion module jumper set at D, will deliver 1250 CFM at stage 2 compressor operation mode, 1090 CFM at stage 1 compressor operation, 1400 CFM in electric heat mode, 700 CFM in fan only mode, 938 CFM in dehumidification mode, 700 CFM in hydronic heat mode and 940 CFM in waterside economizer mode.

Variable CFM

All units have the capability to deliver variable CFM based on the thermostat wiring. By using a multi-stage wall thermostat, the unit can deliver lower CFM as the space temperature is satisfied. For example, unit size 024 with the 4-position switch set a #3, I/O expansion module JP1/JP2 jumpers set at B and a 3-stage cooling wall thermostat will deliver 650 CFM at stage 1 cooling, 700 CFM at stage 2 cooling and 800 CFM at stage 3 cooling. All of this is accomplished by wiring the thermostat to the appropriate terminal on the MicroTech III controller terminal strip. The variable CFM feature allows for improved humidity levels by increasing latent cooling capacity through reduced CFM. Here, we are attempting to satisfy cooling at the lowest airflow, 650 CFM, but having the capability to deliver higher airflow, 800 CFM, if needed.

MicroTech® III SmartSource Controller with LONWORKS® Communication Module



Each Daikin water source heat pump can be equipped with a LONWORKS communication module that is LONMARK 3.4 certified. The controller is microprocessor-based and is designed to communicate over a LONWORKS communications network. It can be factory or field-installed.

The unit controller is programmed and tested with all the logic required to monitor and control the unit. An optional

wall sensor may be used with the communication module to provide limited local control of the Water Source Heat Pump. The unit controller monitors water and air temperatures and passes information to the communication module. The module communicates with the BAS, to provide network control of the Water Source Heat Pump.

Figure 6: MicroTech III LONWORKS snap-in communication module

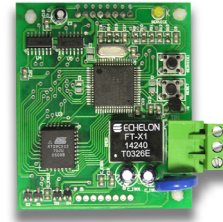

The MicroTech III SmartSource unit controller with communication module includes a unit-mounted return air, discharge air and leaving water temperature sensor. Wall mounted temperature sensors include setpoint adjustment and tenant override. The user has the capability of substituting the wall sensor with a duct-mounted return air sensor.

MicroTech III SmartSource Unit Controller with LONWORKS Communication Module orchestrates the following unit operations:

- Enable heating and cooling to maintain setpoint based on a room sensor
- Enable fan and compressor operation
- Monitors all equipment protection controls
- Monitors room and discharge air temperatures
- Monitors leaving water temperature
- Relays status of all vital unit functions

The MicroTech III SmartSource unit controller with communication module includes:

- A Return Air Temperature sensor (RAT) (factory provided, field-installed)
- A Discharge Air Temperature sensor (DAT) (factory provided, field-installed)
- A Leaving Water Temperature sensor (LWT)

Note: Refer to IM 956-X for details to install (RAT), (DAT) and (LWT) sensors.

The communication module provides access to setpoints for operational control

Available wall sensors include:

- Digitally Adjustable with Temperature & Humidity Display
- Adjustable Cool/Warm with Occupancy Switch
- Adjustable 55°F to 95°F
- Adjustable -3°F to +3°F (-1.5°C to +1.5°C)
- Basic Room Sensor With Cool to Warm
- Basic Room Sensor
- Basic Sensor

MicroTech III SmartSource Controller with BACnet® Communication Module



Daikin water source heat pumps are available with a BACnet MS/TP communication module that is designed to communicate over a BACnet MS/TP communications network to a building automation system (BAS). It can be factory or field-installed.

The unit controller is programmed and tested with all the logic required to monitor and control the unit. An optional wall sensor may be used with the communication module to provide limited local control of the water source heat pump. The unit controller monitors water and air temperatures and passes information to the communication module. The module communicates with the BAS, to provide network control of the water source heat pump.

The module makes operational data and commands available on a communications network using BACnet objects and properties:

- The network cable is a shielded twisted-pair cable
- Network communications run up to 76.8 Kbps
- DIP switches on the controller enable the MS/TP MAC address to be set in the range 0-127
- Four green status LEDs on the communication module indicate communication activity on the MS/TP communication network and with the unit controller

Figure 7: MicroTech III BACnet snap-in communication module

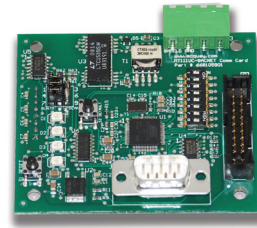

MicroTech III SmartSource unit controller with BACnet MS/TP Communication Module orchestrates the following unit operations:

- Enable heating and cooling to maintain setpoint based on a room sensor
- Enable fan and compressor operation
- Monitors all equipment protection controls
- Monitors room and discharge air temperatures
- Monitors leaving water temperature
- Relays status of all vital unit functions

The MicroTech III SmartSource unit controller with communication module includes:

- A Return Air Temperature sensor (RAT) (factory-provided, field-installed)
- A Discharge Air Temperature sensor (DAT) (factory-provided, field-installed)
- A Leaving Water Temperature sensor (LWT)

Note: Refer to IM 956-X for details to install (RAT), (DAT) and (LWT) sensors.

The communication module provides access to setpoints for operational control.

Available wall sensors include:

- Digitally Adjustable with Temperature & Humidity Display
- Adjustable Cool/Warm with Occupancy Switch
- Adjustable 55°F to 95°F
- Adjustable -3°F to +3°F (-1.5°C to +1.5°C)
- Basic Room Sensor With Cool to Warm
- Basic Room Sensor
- Basic Sensor

Hoses, Hose Kits and Shutoff Ball Valves for SmartSource Water Source Heat Pumps

Daikin sells a variety of flexible supply, return and condensate hoses and hose assemblies for connecting its water source heat pumps to a building's hard piping system. See catalog 1196-x for the complete hose and hose kit offering.

Figure 8: Flexible, steel braided supply and return hoses



Supply and return hoses have a swivel fitting at one end to facilitate removal of the unit for replacement or service. Standard supply and return fire-rated hoses have either a thermoplastic rubber or synthetic polymer core with a braided covering of stainless steel. Fittings are either plated steel or brass.

Table 2: Available fire rated supply and return hoses

Description	Connection Size (O.D.)	Length
Supply and Return Hoses	1/2"	24"
		36"
	3/4"	24"
		36"
	1"	24"
		36"

Shutoff Ball Valves with Memory Stop

Constructed of brass and rated at 400 psig (2758 kPa) maximum working pressure. Valves have a built-in adjustable memory stop to eliminate rebalancing. Valves have FPT connections on both ends for connection to the water hose and to the field piping.

Figure 9: Shutoff ball valve with memory stop



2 & 3-Way Motorized Water Valves

2-way valves are used for variable pumping applications when more than one unit is installed on a common loop. These valves are also used to conserve water when used for ground water applications.

3-way valves are used for constant flow applications or installed at the end of a variable flow branch piping run to maintain minimum flow conditions.

Figure 10: 2-way and 3-way motorized water valves



Table 3: Available motorized valves

Type	Size	Connection
2-Way Motorized	1/2"	Sweat
	3/4"	Sweat
	1"	Sweat
	1/2"	NPT
	3/4"	NPT
	1"	NPT
3-Way Motorized	1/2"	Sweat
	3/4"	Sweat
	1"	Sweat

Supply and Return Hose Kits

Figure 11: Supply and return hoses



Supply Hose - Combination Ball Valve & Strainer

The supply valve body is a combination Y-strainer full port shut-off valve and union for use in HVAC systems. Strainers are furnished with a 20 mesh stainless steel screen, hose end drain (blow down) valve for purging, one pressure/temperature port for commissioning, and one plugged bypass port. Three additional 1/4" taps are plugged and available for accessories when specified. A variety of pipe connections are available on both the fixed and union ends. Standard end connections are female pipe thread.

Condensate Hose Kits



Horizontal ceiling units require an external condensate hose. These can be ordered as the long clear plastic type with the necessary clamps and a MPT hose fittings, or fire rated type for connection to the FPT field piping.

Table 4: Available condensate hose kits

Description	Size & Nominal Length
Hose, Fire Rated Condensate	3/4" FPT x 24"
Hose, Fire Rated Condensate	3/4" FPT x 36"
Hose, Plastic Condensate w/Fittings	3/4" x 30"
Hose, Plastic Condensate w/Fittings	3/4" x 36"

Electric Duct Heaters (Horizontal Units)

Horizontal units utilize a (field-installed) external duct-mounted electric heater. With boilerless electric heat, if the EWT is above the set point of the EWT thermostat, a switch is located in the control box to activate electric heat in the event of a compressor failure. With supplemental electric heat control the compressor and heater operate simultaneously, activated by a wall thermostat. "Emergency heat" is activated by a 24V signal for external duct-mounted electric heat. This function is activated from the wall thermostat via the "Emergency Heat" switch.

Figure 12: External electric heater (field-installed)

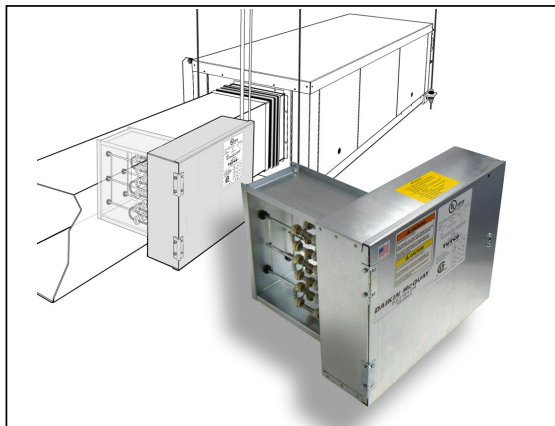
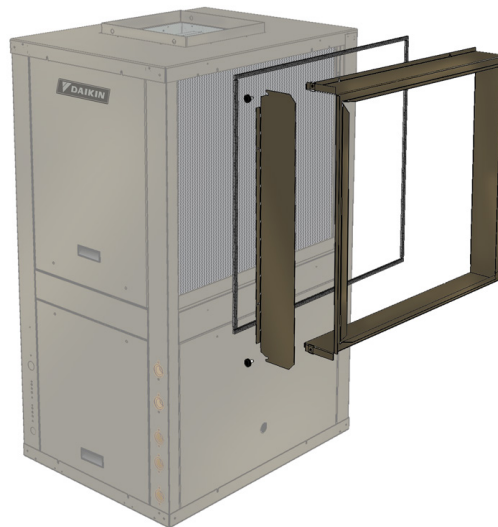

Table 5: Available electric duct heaters

Description	kW	Voltage/Hz/Phase	Unit Size
Electric Duct Heater Kit	5	208-240/60/1	024-030
		208-240/60/3	
		277/60/1	
		480/60/3	
	10	208-240/60/1	024-030
		208-240/60/3	
		277/60/1	
		480/60/3	
	5	208-240/60/1	036-070
		208-240/60/3	
		277/60/1	
		480/60/3	
10	208-240/60/1	036-070	
	208-240/60/3		
	277/60/1		
	480/60/3		
15	208-230/60/1	036-070	
	208-230/60/3		
	460/60/3		
20	208-230/60/1	036-070	
	208-230/60/3		
	460/60/3		

Filters

A 2" or 4" filter rack is available as a field-installed accessory to accept a Merv 8 or Merv 13 filter, for applications requiring optimal Indoor Air Quality (IAQ). The high Merv filter rack is provided with gaskets between it and the cabinet and along the edge of the tool-less removable door. The gaskets maintain the leakage rate below 4 CFM per square foot of filter area at .5" ESP.



Loop Circulating Pump Modules



Single pump module



Dual pump module

Features

- Fully insulated cabinet eliminates condensation
- No assembly required
- All pump modules are leak tested
- Full flow 1-1/8" brass valves
- Standard 1" NPT connections
- Compatible with all industry components
- Functions smoothly and quietly
- Easy access to valves and circulators for ease of service
- 14-3/4" x 13-1/4" x 7" unit size makes for a compact unit
- Installation hose kit available
- Five year parts & labor warranty

Operation

The circulator pumps in a geothermal loop energizes and circulates the liquid through a geothermal heat pump and the earth loop. This results in the transfer of heat.

Installation

Wall Mounting Designed for quick and easy installation, the loop pump module can be attached to most any wall using the screws and the mounting holes provided on the back flange of the pump module. External connections are standard 1" NPT to accommodate industry standard fittings.

Filling and Flushing

Filling and flushing of the pump module occurs through the connections at front. To direct flow, the module's two brass valves rotate to four positions.

Local Codes

The Daikin pump modules meet or exceed most city and state building codes, but it is recommend that installers always check local city installation requirements that may be unique to their geographic region.

Loop Pump Modules Specifications:

Single Pump Geothermal Loop Modules

Module Dimensions: 14 3/4" x 13 1/4" x 7 1/8"

Available Bell & Gossett Circulators

(All Circulators)..... 1 Phase 60 Hz

Cast Iron 230 VAC

Load:..... Low 0.6A /Med
..... 0.8A /High 1.2A

Bronze 230 VAC

Load:..... Low 0.6A /Med
..... 0.8A /High 1.2A

Approved Liquid Solutions:

Methanol, Exoendosol, Propylene Glycol

Additional Information:

Minimum Valve Bore:..... 1-1/8"

External Piping Connections 1" NPT

Maximum Operating Pressure:..... 150 PSI

Minimum Operating Temperature: 0°F

Maximum Operating Temperature: 225°F

Weight: 34 lbs.

Dual Pump Geothermal Loop Modules

Module Dimensions: 14 3/4" x 13 1/4" x 7 1/8"

Available Bell & Gossett Circulators

(All Circulators)..... 1 Phase 60 Hz

Cast Iron 230 VAC..... (2 pumps)

Load:..... Low 1.2A /Med
..... 1.6A / High 2.4A

Bronze 230 VAC (2 pumps)

Load:..... Low 1.2A /Med
..... 1.6A /High 2.4A

Approved Liquid Solutions:

Methanol, Exoendosol, Propylene Glycol

Additional Information:

Minimum Valve Bore:..... 1-1/8"

External Piping Connections 1" NPT

Maximum Operating Pressure:..... 150 PSI

Minimum Operating Temperature: 0°F

Maximum Operating Temperature: 225°F

Weight: 44 lbs.

Figure 13: Single pump performance curve

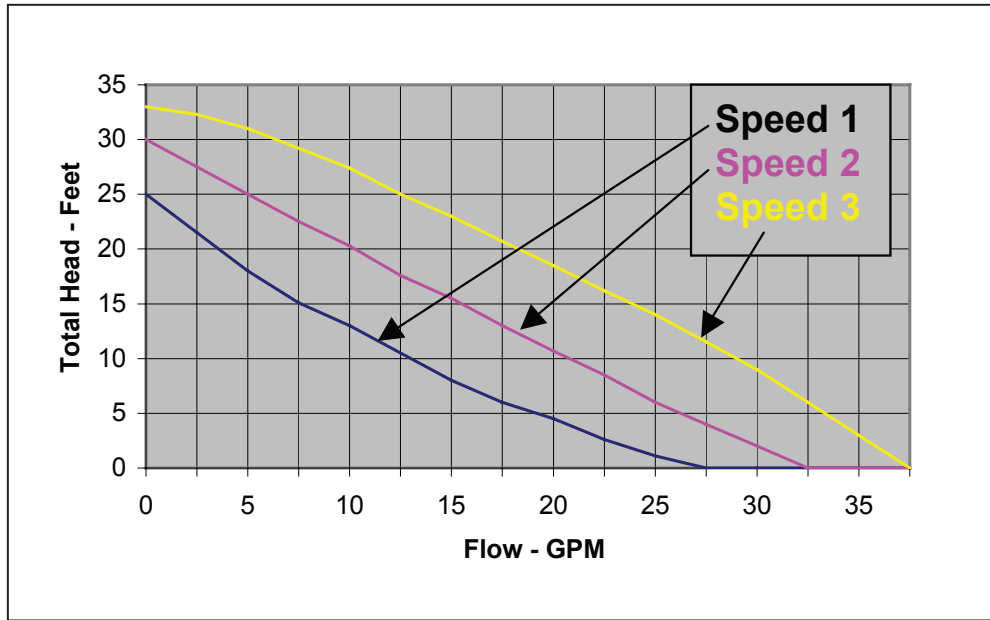
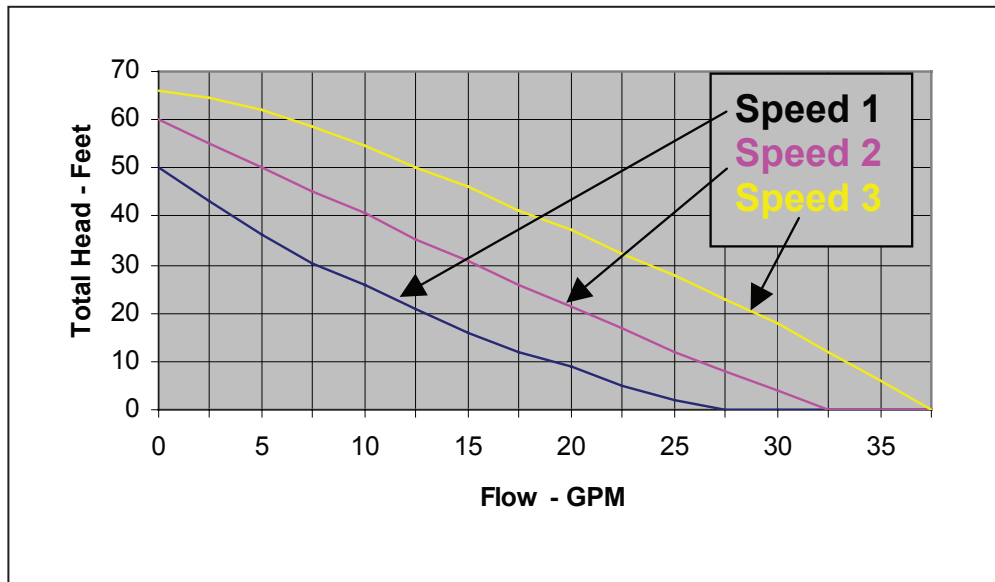

Figure 14: Dual pump performance curve



Typical Vertical Installation

Unit Location

SmartSource vertical water source heat pumps can be installed “free standing” in an equipment room; however, closet installations are more common for the small vertical type units. Generally, the unit is located in the corner of a closet with the non-ducted return air facing 90° to the door and the major access panels facing the door as shown in Figure 15. Alternatively, the unit can have a ducted return air with the opening facing the door and the major access panels facing 90° to the door.

Locate a vertical unit to allow for easy removal of the filter and access panels. Allow a minimum of 18" (46 cm) clearance on each side of the unit for service and maintenance access. Always be sure to leave at least one side of the filter rack unobstructed so that the service personnel will be able to slide the filter out.

Install a field supplied line voltage disconnect for branch circuit protection.

To reduce noise emissions, install a field-provided 1/2 inch thick, isolator pad below the entire base of the vertical unit. The pad should be equal to the overall foot-print size of the unit to provide sound dampening of the unit while in operation.

Figure 15: Typical closet installation - non-ducted application

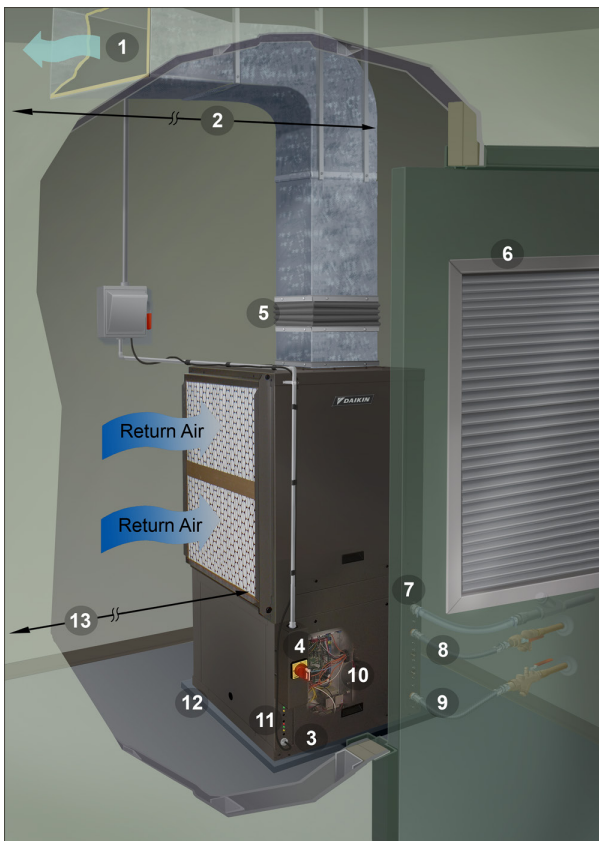

1. Discharge air
2. Acoustic thermal duct lining - 10 feet
3. Low voltage wiring to unit control box
4. Line voltage disconnect
5. Flexible duct collar
6. Louvered closet door
7. Condensate drain
8. Flexible, braided, stainless steel return hose with flow controller/ball valve with port
9. Flexible, braided, stainless steel supply hose with Y-strainer/ball valve with port
10. Access to unit control box
11. LED annunciator lights indicate unit operation status and faults
12. Full vibration isolation pad between unit and floor
13. Minimum distance between return air duct collar and wall for non-ducted return applications
 - Size 007-012 – 5 inches
 - Size 015-024 – 5 inches
 - Size 030-036 – 6 inches
 - Size 042-048 – 8 inches
 - Size 060-070 – 10 inches

Figure 16: Vertical unit wiring & piping locations

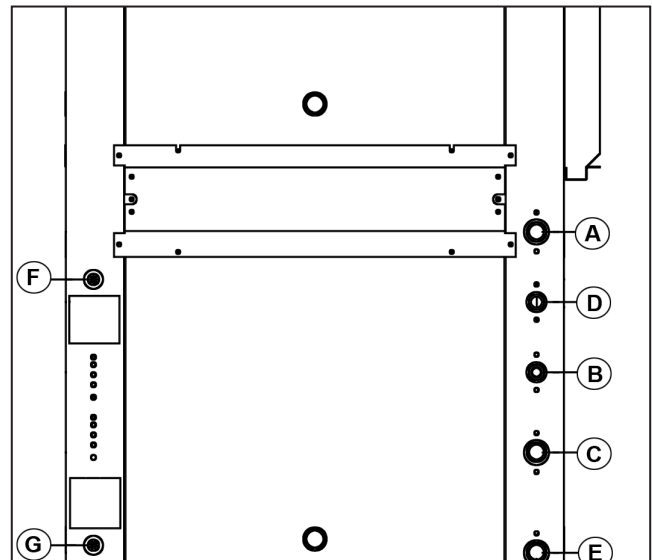

- A- Condensate
- B- Water return
- C- Desuperheater water return (optional)
- D- Desuperheater water supply (optional)
- E- Water supply
- F- Line voltage unit power (electric entrance)
- G- Low voltage control Wiring (electric entrance)

Typical Horizontal Installation

Unit Location

It is important to leave enough space for service personnel to perform maintenance or repair. Locate the horizontal unit to allow for easy removal of the filter and access panels. Allow a minimum of 18" (46 cm) clearance on each side of the unit for service and maintenance access and do not install the unit above any piping. Always be sure to leave at least one side of the filter rack unobstructed so that the service personnel will be able to slide the filter out. Each unit is suspended from the ceiling by four 3/8" threaded rods fastened to the unit by a hanger bracket and rubber isolator. The design should place the unit directly below the structural members so that it is securely anchored.

Avoid installing units directly above spaces where building occupants will reside (e.g. above office desks or classrooms) to reduce the requirement for noise attenuation. Do not place units above high traffic areas because service access may be limited during occupied hours. For example, units are typically installed above the hallway drop ceiling in schools and the supply and return air is routed directly into classrooms. Local code may require fire dampers to be used with this application.

Figure 17: Typical horizontal ceiling installation

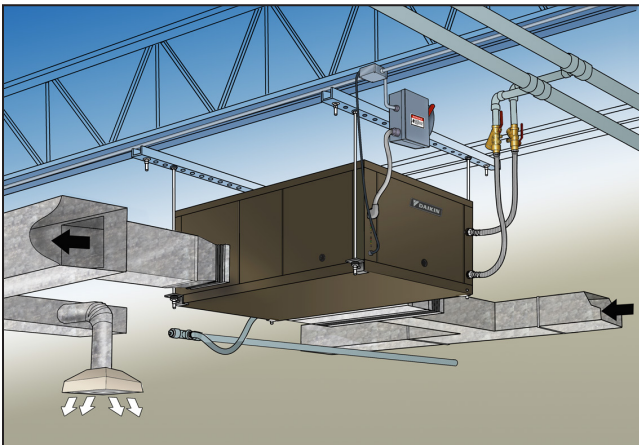

Ductwork and Attenuation

Vertical Unit

All ductwork should conform to industry standards of good practice as described in ASHRAE Systems Guide. The discharge duct system will normally consist of a flexible (boot) connector at the unit, a short run of acoustically insulated duct (approximately 10'), an 90° elbow without vanes, and a trunk duct teeing into a branch circuit with discharge diffusers as illustrated in Figure 19 and Figure 20 on page 23.

Return air ducts can be brought in through a wall grille and then to the unit. The return duct system will normally consist of a flexible connector at the unit and a trunk duct to the return air grille. With metal duct material, the return air duct should be internally lined with acoustic insulation for sound attenuation.

Return air ductwork to the unit requires a 2" (51mm) return air duct collar and filter rack or an optional 4" (102 mm) return air duct collar and filter rack.

Figure 18: Typical installation using ducted return

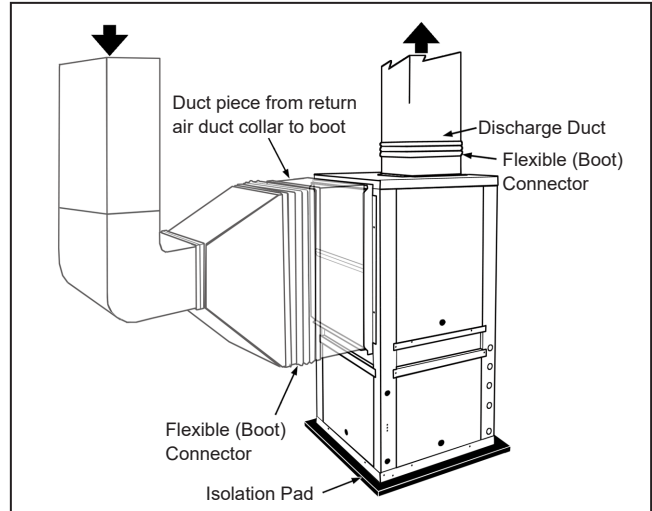

Horizontal Unit

Ductwork is normally applied to ceiling-mounted heat pumps on the discharge side of the unit. A discharge collar is provided on all horizontal unit models for fastening the ductwork. Use a flexible connector between the discharge collar and the duct transformation to help reduce vibration transmission from the cabinet and to simplify disconnection of the unit from the ceiling ductwork. If return ductwork is to be used, attach a flexible connector to the filter rack collar to help reduce vibration transmission and removal of the unit. Return plenum ducting should be at least 12 inches away from the coil so that the coil is evenly loaded with return air.

As a general recommendation, duct interiors should have an acoustic / thermal lining at least 1/2 inch thick over the entire duct run. For better sound attenuation, line the last five diameters of duct before each register with a one-inch thick sound blanket. Elbows, tees and dampers can create turbulence or distortion in the airflow. Place a straight length of duct, 5 to 10 times the duct width, before the next fitting to smooth out airflow. Diffusers that are located in the bottom of a trunk duct can also produce noise. For this same reason, volume control dampers should be located several duct widths upstream from an air outlet.

Figure 19: Vertical unit duct example

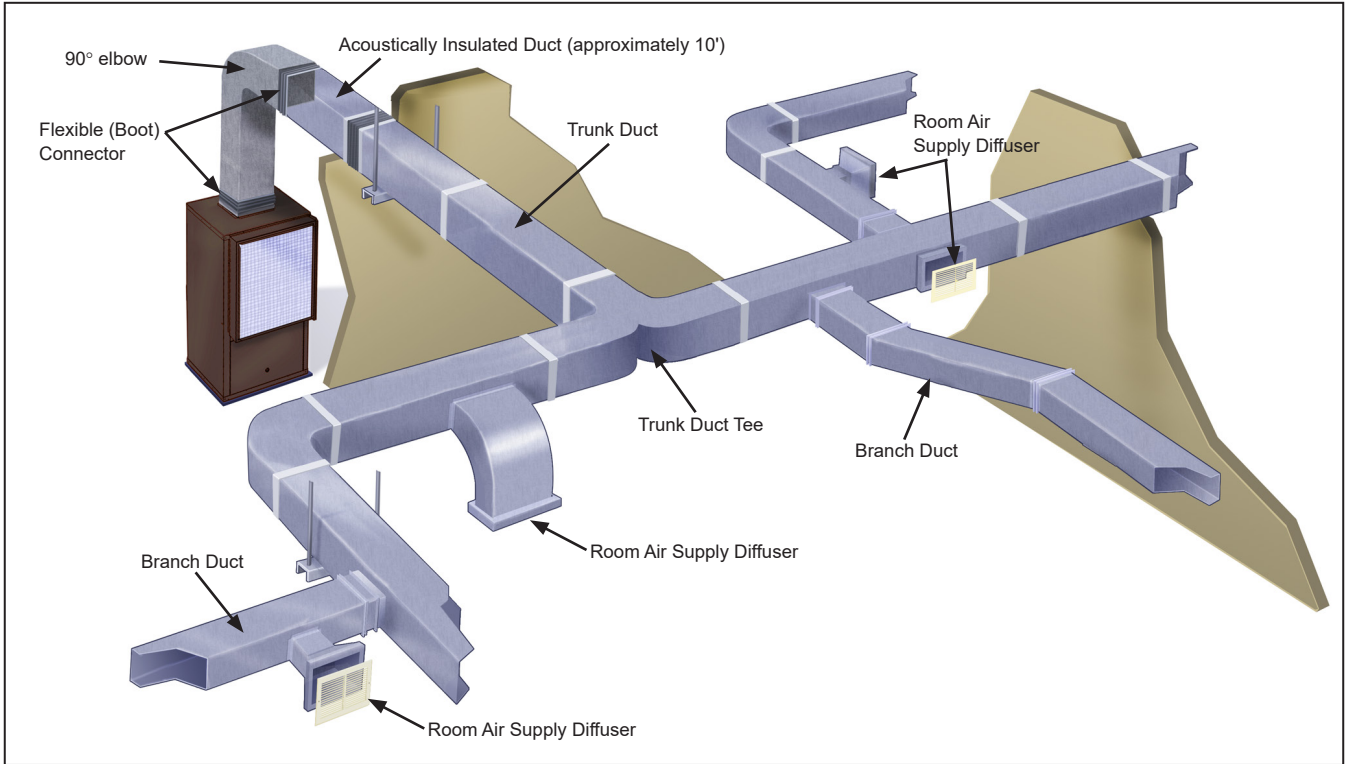
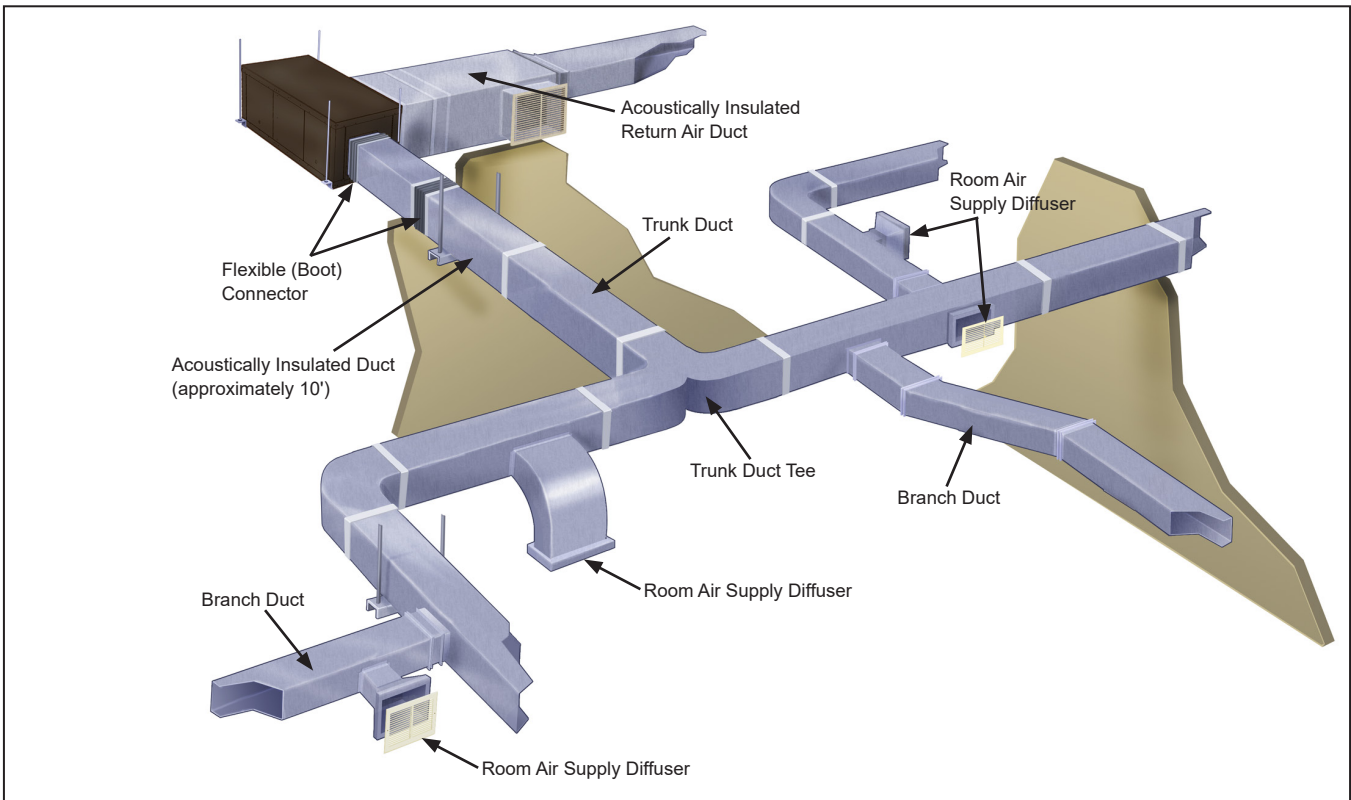

Figure 20: Horizontal unit duct example



Notes:

1. Do not install ducts so that the air flow is counter to fan rotation. If necessary, turn fan section.
2. Transformations and units must be adequately supported so no weight is on the flexible boot connection.

Piping

The water source heat pump unit is typically connected to the supply / return piping using a “reverse return” piping system which includes a flow control device so that flow requirements are met for each zone. A short, high pressure “flexible hose” is used to connect the unit to the building’s hard piping and acts as a sound attenuator for both the unit operating noise and hydronic pumping noise. One end of the hose has a swivel fitting to facilitate removal of the unit for replacement or service. Include supply and return shutoff valves in the design to allow removal of a unit without the need to shut down the entire heat pump system. The return valve may be used for balancing and will typically have a “memory stop” so that it can be reopened to the proper position for the flow required. Fixed flow devices are commercially available and can be installed to eliminate the need for memory stop shut off valves. Include Pressure / Temperature ports to allow the service technician to measure water flow and unit operation.

Daikin has available optional hose kit combinations to better facilitate system flow balancing. These flexible hoses reduce vibration between the unit and the rigid piping system.

Polyolester Oil, commonly known as POE oil is a synthetic oil used in many refrigeration systems. POE oil, if ever in contact with PVC/CPVC will coat the inside wall of PVC/CPVC pipe causing environmental stress fractures.

Although there is no PVC/CPVC piping in this product, please keep this in mind when selecting piping materials for your application, as system failure and property damage could result.

Figure 21: Reverse return piping system

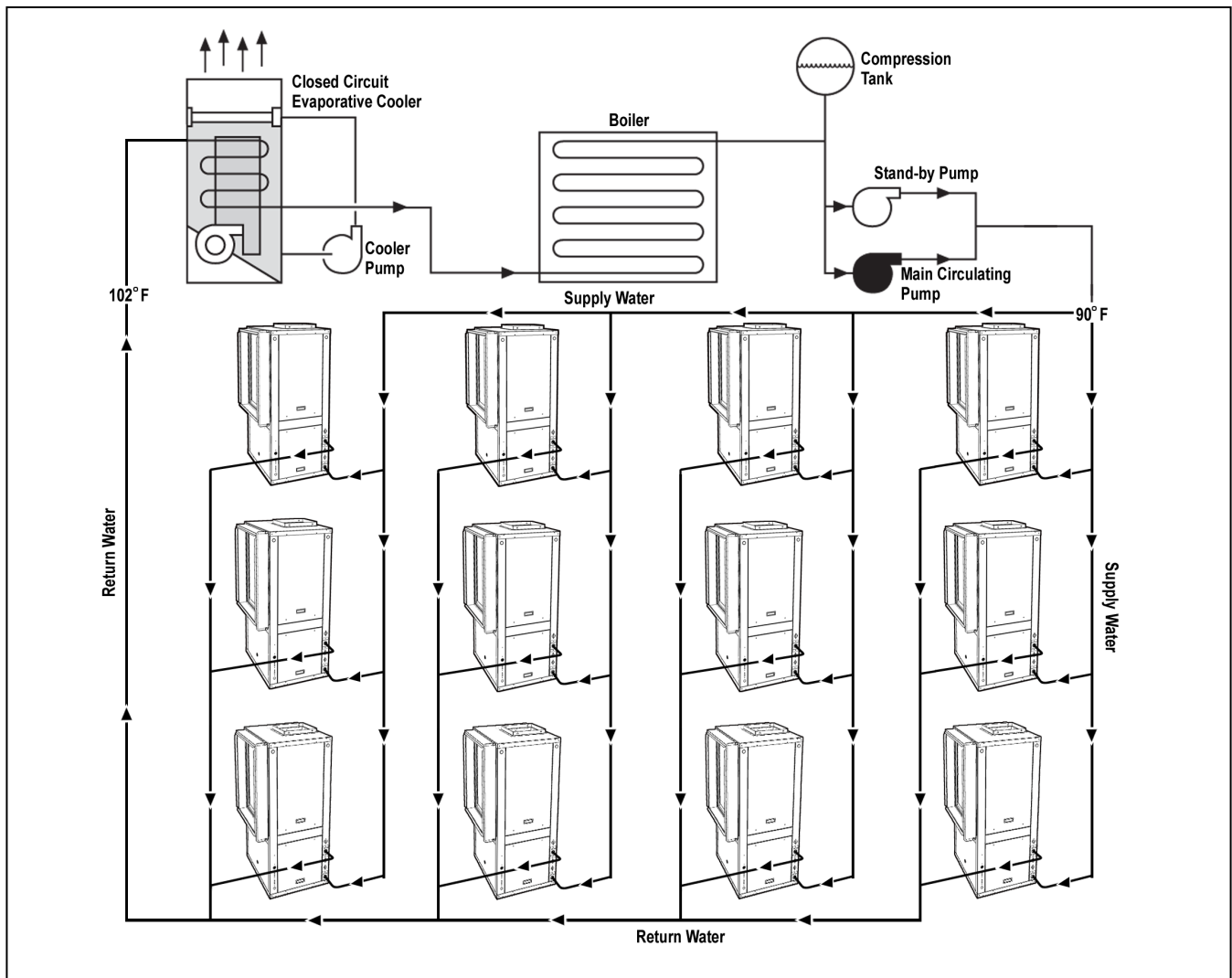

Water System Quality

The cleaning, flushing and chemical treatment of a water source heat pump system is fundamental to efficient operation and the life expectancy of the system.

Potential system problems produced by the use of water fall into three general categories:

1. Scale formation – Mineral deposits which result from the crystallization and precipitation of dissolved salts in the water. The deposits form an insulating barrier, reducing the heat transfer rate and impeding the circulation of fluids due to increased pressure drop.
2. Corrosion – Decomposition of the metal caused by absorption of gases from the air. Corrosion may occur in any metal component of the system.
3. Organic growths – Slime and algae which form under certain environmental conditions, and can reduce the heat transfer rate by forming an insulating coating or can promote corrosion by pitting.

The system water should be evaluated for degrees of impurity, with testing available from independent testing labs, health departments or state agencies.

Table 6 is a list of water characteristics, the potential impurities and their results and the recommended treatment.

Avoiding Potential Problems

As shown in Table 6, all water contains some degree of impurities which may affect the performance of a heat pump system. The use of a cupro-nickel coil can help avoid potential problems. Water flow rates should:

- A. Be high enough that the temperature rise through the heat exchanger does not exceed 10° F when operating in the cooling mode.
- B. Not exceed 4 GPM per nominal ton. Flow rates that have velocities of 10 feet per second or more may cause pipe erosion and heat exchanger failure.

Table 6: Water impurities, result & recommended water system application

Impurity	Copper Coils	Cupro-nickel Coils	Result	Application	
				Open Recirculating	Closed Recirculating
Calcium & Magnesium Salts (hardness)	Less than 350 ppm	350 ppm Sea Water	Scaling	1. Bleed-off 2. Surface active agents such as polyphosphates. 3. Addition of acid. 4. pH adjustment. Other considerations: • Adequate fouling factor • Surface temperature • Water temperature • Clean system	No treatment required
Ironoxide	Low levels only	Moderate levels	Corrosion	1. Corrosion inhibitors in high concentrations (200 to 500 ppm). 2. Corrosion inhibitors in low concentrations (20 to 80 ppm). 3. pH control. 4. Proper materials of construction.	Corrosion inhibitors in high concentrations. Proper materials of construction.
pH	7 - 9	5 - 10			
Hydrogen Sulfide	Less than 10 ppm	10 - 50 ppm			
CO ₂	Less than 50 ppm	50 - 75 ppm			
Chloride	Less than 300 ppm	300 - 600 ppm			
Total Dissolved Solids	Less than 1000 ppm	1000 - 1500 ppm			
Slime & Algae	Slime and algae can form under certain environmental conditions		Reduced heat transfer due to forming of insulating coating, or pitting due to corrosion	Chlorinated phenols. Other biocides. Chlorine by hypochlorites or by liquid chlorine	No treatment required

- Notes:**
1. The tremendous variety in water quality around the country makes the recommendation of a single best method of treatment impossible. Consult a local water treatment specialist for specific treatment recommendations.
 2. Cupro-nickel is recommended if iron bacteria is high, suspended solids or dissolved oxygen levels are high.
 3. If the concentration of these corrosives exceeds the maximum tabulated in the cupro-nickel column, then the potential for serious corrosion problems exists.

Condensate Drain

Vertical units are factory provided with a condensate drain trap located inside the cabinet. Condensate removal piping must be pitched away from the unit not less than 1/4" per foot. A vent is required after the trap so that the condensate will drain away from the unit. The vent can also act as a clean out if the trap becomes clogged. To avoid having waste gases entering the building, the condensate drain should not be directly piped to a drain/waste/vent stack. See local codes for the correct application of condensate piping to drains.

Figure 22: Condensate trap detail

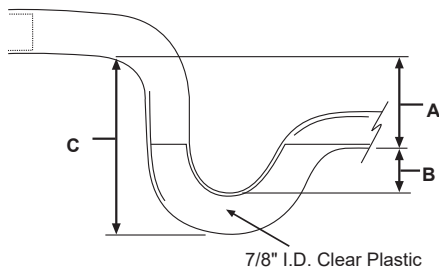

Improper trapping can lead to several problems. If the trap is too tall, negative pressure will prevent drainage, causing condensate backup. If the trap is too short the seal will be destroyed or nonexistent, producing the same effect as a non-trapped system.

Construct the trap of 7/8" clear plastic piping. The condensate piping from the drain trap must be sloped to facilitate proper drainage. The clear plastic trap should be clamped and removable for cleaning. It may be necessary to manually fill the trap at system startup, or to run the unit for sufficient time to build a condensate seal. The condensate trap and condensate piping drainage should be free of any foreign debris. Debris can prevent proper drainage and unit operation and result in condensate buildup.

Table 7: Condensate drain static pressures

Static Pressure	A	B	C
Standard	1-1/4"	5/8"	2-3/4"
High	1-1/2"	3/4"	3-1/8"

Operating Limits

Air Limits

Table 8: Air limits in °F (°C)

Air Limits	Standard Range Units		Extended Range (Geothermal) Units	
	Cooling	Heating	Cooling	Heating
Minimum Ambient Air ¹	50°F (10°C)	50°F (10°C)	40°F (4°C)	40°F (4°C)
Maximum Ambient Air ²	100°F/77°F (38°C/25°C)	85°F (29°C)	100°F/77°F (38°C/25°C)	85°F (29°C)
Minimum Entering Air ¹	65°F/55°F (18°C/13°C)	50°F (10°C)	65°F/55°F (18°C/13°C)	50°F (10°C)
Common Design Entering Air	75°F/63°F (24°C/17°C)	70°F (21°C)	75°F/63°F (24°C/17°C)	70°F (21°C)
Maximum Entering Air ²	85°F/71°F (29°C/22°C)	80°F (27°C)	85°F/71°F (29°C/22°C)	80°F (27°C)

Fluid Limits

Table 9: Fluid limits

Fluid Limits	Standard Range Units		Extended Range (Geothermal) Units	
	Cooling	Heating	Cooling	Heating
Minimum Entering Fluid	55°F (13°C)	55°F (13°C)	30°F (-1°C)	20°F (-6°C)
Common Design Entering Fluid	85-90°F (29-32°C)	70°F (21°C)	90°F (32°C)	35-60°F (1.5-16°C)
Maximum Entering Fluid	120°F (43°C)	90°F (32°C)	120°F (43°C)	90°F (32°C)
Minimum GPM/Ton	1.5			
Nominal GPM/Ton	3.0			
Maximum GPM/Ton	4.0			

- Notes:**
1. Maximum and minimum values may not be combined. If one value is at maximum or minimum, the other two conditions may not exceed the normal condition for standard units. Extended (Geothermal) range units may combine any two maximum conditions, but not more than two, with all other conditions being normal conditions.
 2. This is not a normal or continuous operating condition. It is assumed that such a start-up is for the purpose of bringing the building space up to occupancy temperature.

Unit Selection

Achieving optimal performance with water source heat pump systems requires both accurate system design and proper equipment selection. Use a building load program to determine the heating and cooling loads of each zone prior to making equipment selections. With this information, the Daikin SelectTools™ software selection program for Water Source Heat Pumps can be used to provide fast, accurate and complete selections of all water source heat pump products. SelectTools software is available by contacting your local Daikin Representative.

While it is recommend that you use SelectTools software for all unit selections, manual selections can be accomplished using the same zone load information and the capacity tables available in this catalog.

Boiler/Tower (Water Loop) Application:

The following example illustrates a typical selection for a unit in a boiler/tower system for a commercial building.

The load in this zone requires 41,099 Btuh of total cooling, 30,327 Btuh of sensible cooling and 37,758 Btuh of total heating. The entering water temperatures for the design conditions are 90°F for cooling and 70°F for heating. The return air temperature is 80°F dry bulb with 67°F wet bulb and 70°F for heating.

Zone Requirement:

Total Cooling Load	=	41,099 Btuh
Sensible Cooling Load	=	30,327 Btuh
Heating Load	=	37,758 Btuh
Design Air Flow	=	1,200 CFM
Return Air - Cooling	=	80°F DB/67°F WB
Return Air - Heating	=	70°F DB
Water Flow (Based on Cooling)	=	10.5 GPM

Since a Model GS *036 produces approximately 36,100 total cooling and 27,000 Btuh sensible cooling capacity, it is not sufficient for this zone and a model GS *042 should be considered.

Selection:

Model..... GS *042

After making the preliminary selection (GS*042) enter the performance from the tables on [page 46](#) and [page 47](#) at the design conditions and read Total Cooling, Sensible Cooling, and Heating Capacity at 10.5 GPM:

Total Cooling Capacity	=	43,500 Btuh
Sensible Cooling Capacity	=	31,400 Btuh
Heating Capacity	=	50,600 Btuh

Note: *The above performances are based on 1,400 CFM; therefore, the capacities need to be adjusted to reflect the unit performance at the zone required CFM.*

Determine the air flow correction factors from [Table 14 on page 57](#). For this example use Air Flow Setting #2 (1225 CFM):

$$\text{Corrected Total Cooling} = 43,500 \times 0.987 = 42,935 \text{ Btuh}$$

$$\text{Corrected Sensible Cooling} = 31,400 \times 0.952 = 29,893 \text{ Btuh}$$

$$\text{Corrected Total Heating} = 50,600 \times 0.991 = 50,145 \text{ Btuh}$$

Compare the corrected Total Cooling, Corrected Sensible Cooling, and the Corrected Total Heating figures to the Zone requirements.

Since the sensible capacity is slightly less than the design sensible load, judgment must be used to determine if the next larger capacity unit is necessary. Oversized equipment should be avoided to minimize the potential for humidity and comfort issues.

Next, determine the power correction factors from [Table 14 on page 57](#) using Air Flow Setting #2 (1225 CFM):

$$\text{Corrected Cooling Input Power} = 2.835 \times 0.968 = 2.744 \text{ kW}$$

$$\text{Corrected Heating Input Power} = 2.989 \times 0.996 = 2.977 \text{ kW}$$

The resulting efficiencies can be determined using the corrected capacities and input power:

$$\text{EER} = \text{Cooling Capacity (Btuh)} \div \text{Input Power (Watts)}$$

$$\text{EER} = 42,935 \text{ Btuh} \div (2.744 \text{ kW} \times 1000) = 15.7$$

$$\text{COP} = \text{Heating Capacity (Watts)} \div \text{Input Power (Watts)}$$

$$\text{COP} = (50,145 \text{ Btuh} \div 3.412) \div (2.977 \text{ kW} \times 1000) = 4.94$$

Geothermal (Ground Loop) Application:

The following example illustrates the same zone in a geothermal application.

The space requirements for the zone are the same as the previous example – 41,099 Btuh of total cooling and 30,327 Btuh of sensible cooling and 37,758 Btuh of heating. Geothermal loop software programs are available to help determine the size of the loop field based on:

- Desired entering water temperatures for the system.
- Specific loop field design criteria based on acreage available, loop field spacing, vertical bore depth, piping selected, flow rates, circulated heat transfer fluid, and local formation geology for the loop which produces specific min./max. loop temperatures for the unit selection.

Entering fluid temperatures for geothermal systems can be as high as 110°F and as low as 20°F. Design entering fluid temperatures for heating and cooling are selected by the design engineer based on building loads, ground temperatures, and soil conditions. Typical design entering fluid temperatures are 90°F for cooling (summer) and 45°F for heating (winter). As a rule of thumb, the design entering fluid temperature for cooling is 10°F below the maximum outdoor air temperature, and the design entering fluid temperature for heating is 40°F above the minimum outdoor air temperature. Water flow rates are typically 2.5 to 3.0 GPM per ton and the use of anti-freeze is recommended in most northern applications.

Zone Requirement:

- Total Cooling Zone = 41,099 Btuh
- Sensible Cooling Zone = 30,327 Btuh
- Heating Zone = 37,758 Btuh
- Design Air Flow = 1,200 CFM
- Return air – Cooling = 80°F DB/67°F WB
- Return air – Heating = 70°F
- Entering Fluid Temperature - Cooling = 100°F
- Entering Fluid Temperature - Heating = 45°F

A Model GS *042 is chosen for this geothermal application. Model “GS” offers insulated water piping for condensation considerations and a different freeze setting to allow entering fluid temperatures down to 20°F (with antifreeze). Output capacities should be recalculated using the antifreeze correction tables shown on page 64. The Model GS *042 is first considered but may not meet the Zone requirements due to the reduced entering fluid temperatures (45°F) and an antifreeze solution of 20% propylene Glycol.

Selection:

Model GS *042
 From the capacity tables on page 46 & page 47.

- Total cooling capacity = 41,400 Btuh
- Table Sensible cooling = 30,500 Btuh
- Total heating capacity = 38,550 Btuh
- Next, determine the airflow and antifreeze correction factors.
- Corrected Capacity = Capacity Table Data × Air Flow Correction × Antifreeze Correction
- Corrected Total Cooling = 41,400 × 0.987 × 0.980 = 40,045 Btuh
- Corrected Sensible Cooling = 30,500 × 0.952 × 0.980 = 28,455 Btuh
- Corrected Heating Capacity = 38,550 × 0.991 × 0.975 = 37,248 Btuh

Since the sensible capacity is slightly less than the design sensible load, judgment must be used to determine if the next larger capacity unit is necessary. Oversized equipment should be avoided to minimize the potential for humidity and comfort issues.

Next, determine the power correction factors from Table 11 on page 55 using Air Flow Setting #2 (1225 CFM):

Corrected Cooling Input Power = 3.165 × 0.968 = 3.064 kW

Corrected Heating Input Power = 2.679 × 0.996 = 2.668 kW

The resulting efficiencies can be determined using the corrected capacities and corrected input power:

EER = Cooling Capacity (Btuh) ÷ Input Power (Watts)

EER = 40,045 Btuh ÷ (3.064 kW × 1000) = 13.1

COP = Heating Capacity (Watts) ÷ Input Power (Watts)

COP = (37,248 Btuh ÷ 3.412) ÷ (2.668 kW × 1000) = 4.09

* - indicates Vertical or Horizontal configuration.

Loop Pump Application and Selection

The SmartSource loop pump package is intended for systems designed specifically for distributed or decentralized pump applications eliminating the need for central pumping systems. These systems can be applied to geothermal or boiler/tower applications. However, geothermal applications tend to be more common since system head losses can be better managed to suite the system design requirements. To do so, attention must be given to minimize head loss in the piping system. These recommendations include:

- Minimize head loss in headers and unit flex hose connections to less than 4 ft. per 100 ft of pipe
- Vertical bore length should be limited to:
 - 200 ft. for 3/4" HDPE U-tube pipe
 - 300 ft. for 1" HDPE U-tube pipe
 - 500 ft. for 1¼" HDPE U-tube pipe

- Notes:**
1. Unit head loss should not exceed 12 ft. of water.
 2. Use ball or butterfly valves to minimize head loss.
 3. Do not use flow control devices such as Circuit Sentry™ flow regulating valves Control valves, if necessary, Cv should be greater than or equal to the unit flow rate.

The benefit of a decentralized system can be realized by minimizing head loss while allowing the SmartSource loop pump(s) to cycle on when there is a call for heating or cooling. This allows the loop pump(s) to remain off during the unit off-cycle. In a typical 40-hour per week operating schedule, a significant portion of the energy consumed by a central pumping systems occurs during unoccupied periods due to reduced pump efficiencies at part load.

However, lower annual energy consumption can be realized with the decentralized SmartSource loop pump(s) when head loss and operating hours are minimized.

The maximum working pressure is 145 psi or 335 ft. of water. As a result, this pump system must be limited to mid-rise building applications of no more than approximately 30 stories high. Excessive working pressure can damage the pump seals and reduce the pump operating life. An intermediate heat exchanger should be considered for high-rise building applications to limit static pressures to no more than 145 psi or 335 ft. of water.

When selecting an appropriate SmartSource loop pump, the working fluid (water plus antifreeze), total head loss and flow must be known. The following represents the typical total head loss calculation for a decentralized geothermal loop pump application:

- Using nominal 2-ton vertical unit W.GTV.1.026
- Fluid – 15% Methanol Solution in Water
- Design EWT Heating - 35°F

(Maximum pressure drop occurs with high density fluid. As a result, the design heating EWT will be used to calculate the Total Head Loss)

- Design Water Flow – 3 gpm/ton or 6 gpm for a 2-ton unit
- Length of 1" HDPE piping between the unit and the loop field manifold – 40 feet of length
- Geothermal Loop – (1) 1" HDPE U-tube - 300 feet bore depth

Component	Head Loss (Ft. of W.C.)
1" HDPE Piping and Elbows	2.3
Geothermal Loop Piping	8.6
Unit – W.GTV.1.026	5.5
Total	16.4

For the design conditions of 6 gpm and a total head loss of 16.4 Ft., select the single pump option. The system curve and pump curve for this selection is shown in Figure 25. As a result, the actual calculated flow will be 7.56 gpm with a head on the pump of 28 ft. Applications with higher head loss may require the (one) high head pump option or one of the two-pump options using either (two) low head pumps or (two) high head pumps option, piped in series. Pumps piped in series provide approximately double the head capability compared to single pump systems. Also see "Loop Pump Performance" curves on page 58.

Figure 23: Dual pumps - heat pump (side view)

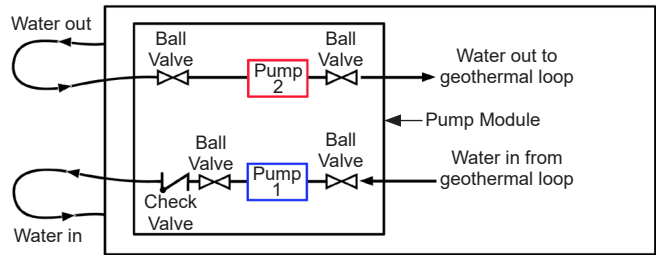

Figure 24: Single pump - heat pump (side view)

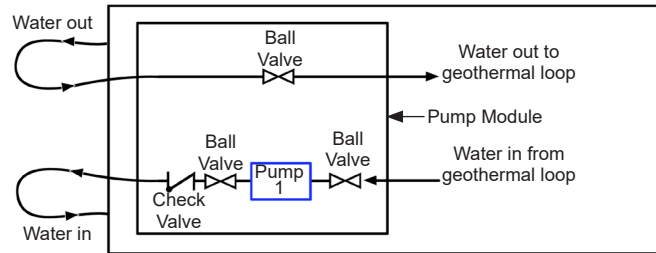
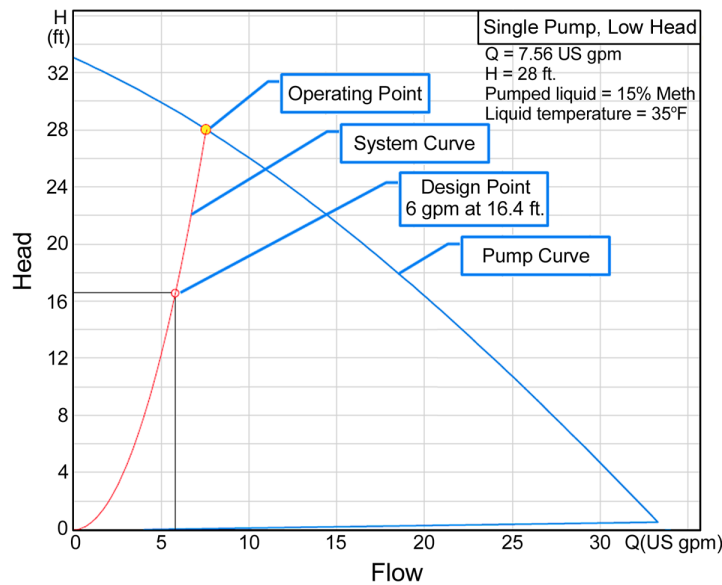

Figure 25: System & pump curve for one, low head pump option



Size 007 (250 CFM)

EWT (°F)	GPM	WPD		EAT (°F)	Cooling					Heating				
		PSI	FT of W.C.		Total (Btu/hr)	Sensible (Btu/hr)	Power Input (kW)	THR (Btu/hr)	EER	Total (Btu/hr)	Power Input (kW)	THA (Btu/hr)	LAT (°F)	COP
20	1.0	0.8	1.8	65/55	Tint = Operation Not Recommended (See "Appendix-A" on page 87 for table legend.)					5200	0.458	3600	85	3.32
		0.8	1.8	70/59						5100	0.478	3500	89	3.13
		0.8	1.8	75/63						4900	0.502	3200	93	2.86
		0.8	1.8	80/67						4800	0.527	3000	98	2.67
	1.5	1.5	3.5	65/55						5300	0.459	3700	86	3.38
		1.5	3.5	70/59						5200	0.478	3600	89	3.18
		1.5	3.5	75/63						5000	0.503	3300	93	2.91
		1.5	3.5	80/67						4900	0.527	3100	98	2.72
	2.0	2.4	5.5	65/55						5400	0.459	3800	86	3.44
		2.4	5.5	70/59						5300	0.479	3700	90	3.24
		2.4	5.5	75/63						5100	0.504	3400	94	2.97
		2.4	5.5	80/67						5000	0.528	3200	98	2.77
30	1.0	0.8	1.8	65/55	6100	0.485	4400	88	3.68					
		0.8	1.8	70/59	7800	0.504	4200	92	3.43					
		0.8	1.8	75/63	8300	0.529	4000	96	3.21					
		0.8	1.8	80/67	8900	0.553	3700	101	2.96					
	1.5	1.5	3.4	65/55	7300	0.485	4500	89	3.74					
		1.5	3.4	70/59	7800	0.505	4300	92	3.48					
		1.5	3.4	75/63	8400	0.530	4100	97	3.26					
		1.5	3.4	80/67	8900	0.554	3800	101	3.01					
	2.0	2.3	5.4	65/55	7300	0.486	4600	89	3.79					
		2.3	5.4	70/59	7800	0.506	4400	92	3.53					
		2.3	5.4	75/63	8400	0.530	4200	97	3.31					
		2.3	5.4	80/67	8900	0.555	3900	101	3.06					
40	1.0	0.7	1.7	65/55	7500	0.506	5300	92	4.05					
		0.7	1.7	70/59	8100	0.526	5100	95	3.84					
		0.7	1.7	75/63	8600	0.550	4900	100	3.62					
		0.7	1.7	80/67	9200	0.575	4600	104	3.36					
	1.5	1.4	3.3	65/55	7600	0.507	5400	92	4.10					
		1.4	3.3	70/59	8100	0.526	5200	96	3.89					
		1.4	3.3	75/63	8600	0.551	5000	100	3.67					
		1.4	3.3	80/67	9200	0.575	4700	105	3.41					
	2.0	2.3	5.2	65/55	7600	0.507	5500	93	4.15					
		2.3	5.2	70/59	8100	0.527	5300	96	3.94					
		2.3	5.2	75/63	8700	0.552	5100	101	3.72					
		2.3	5.2	80/67	9200	0.576	4800	105	3.46					
50	1.0	0.7	1.7	65/55	7600	0.523	6300	96	4.54					
		0.7	1.7	70/59	8100	0.542	6100	99	4.32					
		0.7	1.7	75/63	8700	0.567	5900	104	4.03					
		0.7	1.7	80/67	9200	0.591	5700	108	3.81					
	1.5	1.4	3.2	65/55	7600	0.523	6400	96	4.59					
		1.4	3.2	70/59	8100	0.543	6200	100	4.37					
		1.4	3.2	75/63	8700	0.567	6000	104	4.08					
		1.4	3.2	80/67	9200	0.592	5800	109	3.86					
	2.0	2.2	5.1	65/55	7600	0.524	6500	97	4.64					
		2.2	5.1	70/59	8100	0.544	6300	100	4.42					
		2.2	5.1	75/63	8700	0.568	6100	104	4.12					
		2.2	5.1	80/67	9200	0.593	5900	109	3.90					
60	1.0	0.7	1.6	65/55	7400	0.535	7300	100	4.98					
		0.7	1.6	70/59	8000	0.554	7100	103	4.76					
		0.7	1.6	75/63	8500	0.579	6900	108	4.50					
		0.7	1.6	80/67	9000	0.603	6600	112	4.22					
	1.5	1.4	3.1	65/55	7400	0.535	7400	100	5.03					
		1.4	3.1	70/59	8000	0.555	7200	104	4.80					
		1.4	3.1	75/63	8500	0.579	7000	108	4.55					
		1.4	3.1	80/67	9100	0.604	6700	112	4.27					
	2.0	2.2	4.9	65/55	7500	0.536	7600	101	5.14					
		2.2	4.9	70/59	8000	0.556	7300	104	4.85					
		2.2	4.9	75/63	8500	0.580	7100	109	4.59					
		2.2	4.9	80/67	9100	0.604	6800	113	4.31					
				85/71	9600	6500	0.373	10900	25.7					

Size 007 (250 CFM) (continued)

EWT (°F)	GPM	WPD		EAT (°F)	Cooling					Heating				
		PSI	FT of W.C.		Total (Btu/hr)	Sensible (Btu/hr)	Power Input (kW)	THR (Btu/hr)	EER	Total (Btu/hr)	Power Input (kW)	THA (Btu/hr)	LAT (°F)	COP
70	1.0	0.7	1.6	65/55	7100	5400	0.454	8700	15.6	10100	0.542	8200	103	5.45
		0.7	1.6	70/59	7600	5400	0.450	9100	16.9	10000	0.562	8100	107	5.21
		0.7	1.6	75/63	8200	5700	0.446	9700	18.4	9900	0.586	7900	111	4.94
		0.7	1.6	80/67	8700	6000	0.442	10200	19.7	9700	0.611	7600	116	4.65
	1.5	1.3	3.0	65/55	7100	5400	0.446	8600	15.9	10300	0.543	8400	104	5.55
		1.3	3.0	70/59	7700	5400	0.441	9200	17.4	10100	0.563	8200	107	5.26
		1.3	3.0	75/63	8200	5800	0.437	9700	18.8	10000	0.587	8000	112	4.99
		1.3	3.0	80/67	8700	6100	0.433	10200	20.1	9800	0.612	7700	116	4.69
	2.0	2.1	4.8	65/55	7100	5400	0.437	8600	16.2	10400	0.544	8500	104	5.60
		2.1	4.8	70/59	7700	5500	0.433	9200	17.8	10200	0.563	8300	108	5.30
		2.1	4.8	75/63	8200	5800	0.428	9700	19.1	10100	0.588	8100	112	5.03
		2.1	4.8	80/67	8800	6100	0.424	10200	20.8	9900	0.612	7800	116	4.73
80	1.0	0.7	1.6	65/55	6700	5200	0.507	8400	13.2	11000	0.547	9100	107	5.89
		0.7	1.6	70/59	7200	5300	0.503	8900	14.3	10900	0.566	9000	110	5.64
		0.7	1.6	75/63	7800	5600	0.499	9500	15.6	10800	0.591	8800	115	5.35
		0.7	1.6	80/67	8300	5900	0.494	10000	16.8	10600	0.615	8500	119	5.05
	1.5	1.3	3.0	65/55	6700	5200	0.499	8400	13.4	11100	0.547	9200	107	5.94
		1.3	3.0	70/59	7200	5300	0.494	8900	14.6	11000	0.567	9100	111	5.68
		1.3	3.0	75/63	7800	5600	0.490	9500	15.9	10900	0.591	8900	115	5.40
		1.3	3.0	80/67	8300	5900	0.486	10000	17.1	10700	0.616	8600	119	5.09
	2.0	2.1	4.7	65/55	6700	5300	0.490	8400	13.7	11200	0.548	9300	107	5.99
		2.1	4.7	70/59	7200	5300	0.486	8900	14.8	11100	0.567	9200	111	5.73
		2.1	4.7	75/63	7800	5600	0.481	9400	16.2	11000	0.592	9000	116	5.44
		2.1	4.7	80/67	8300	5900	0.477	9900	17.4	10800	0.616	8700	120	5.13
90	1.0	0.7	1.5	65/55	6200	5000	0.566	8100	10.9	11700	0.547	9800	109	6.26
		0.7	1.5	70/59	6700	5100	0.562	8600	11.9	11600	0.567	9700	113	5.99
		0.7	1.5	75/63	7300	5400	0.558	9200	13.1	11500	0.591	9500	117	5.69
		0.7	1.5	80/67	7800	5700	0.553	9700	14.1	11300	0.616	9200	122	5.37
	1.5	1.3	2.9	65/55	6200	5000	0.558	8100	11.1	11800	0.548	9900	109	6.30
		1.3	2.9	70/59	6700	5100	0.553	8600	12.1	11700	0.568	9800	113	6.04
		1.3	2.9	75/63	7300	5400	0.549	9200	13.3	11600	0.592	9600	118	5.74
		1.3	2.9	80/67	7800	5700	0.545	9700	14.3	11400	0.617	9300	122	5.41
	2.0	2.0	4.7	65/55	6200	5100	0.549	8100	11.3	11900	0.549	10000	110	6.35
		2.0	4.7	70/59	6800	5100	0.545	8700	12.5	11800	0.568	9900	113	6.08
		2.0	4.7	75/63	7300	5400	0.540	9100	13.5	11700	0.593	9700	118	5.78
		2.0	4.7	80/67	7800	5700	0.536	9600	14.6	11500	0.617	9400	122	5.46
100	1.0	0.7	1.5	65/55	5700	4800	0.631	7900	9.0	Tint = Operation Not Recommended Notes: 1. Operation below 40°F EWT is based upon a 15% methanol anti-freeze solution. 2. Performance stated is at the rated power supply; performance may vary as the power supply varies from the rated. 3. See performance correction tables for operating conditions other than those listed. 4. Interpolation is permissible; extrapolation is not. 5. For performance data outside the EAT listed, refer to the Daikin SelectTools selection program. 6. Table does not reflect fan or pump power corrections for AHR/ISO conditions. 7. Data is base on unit at full load operation.				
		0.7	1.5	70/59	6200	4900	0.627	8300	9.9					
		0.7	1.5	75/63	6700	5200	0.622	8800	10.8					
		0.7	1.5	80/67	7300	5500	0.618	9400	11.8					
	1.5	1.3	2.9	65/55	5700	4900	0.622	7800	9.2					
		1.3	2.9	70/59	6200	4900	0.618	8300	10.0					
		1.3	2.9	75/63	6800	5200	0.614	8900	11.1					
		1.3	2.9	80/67	7300	5500	0.609	9400	12.0					
	2.0	2.0	4.6	65/55	5700	4900	0.613	7800	9.3					
		2.0	4.6	70/59	6200	4900	0.609	8300	10.2					
		2.0	4.6	75/63	6800	5200	0.605	8900	11.2					
		2.0	4.6	80/67	7300	5500	0.601	9400	12.2					
110	1.0	0.7	1.5	65/55	5100	4600	0.701	7500	7.3					
		0.7	1.5	70/59	5700	4700	0.697	8100	8.2					
		0.7	1.5	75/63	6200	5000	0.692	8600	9.0					
		0.7	1.5	80/67	6800	5300	0.688	9100	9.9					
	1.5	1.3	2.9	65/55	5200	4600	0.692	7600	7.5					
		1.3	2.9	70/59	5700	4700	0.688	8000	8.3					
		1.3	2.9	75/63	6300	5000	0.684	8600	9.2					
		1.3	2.9	80/67	6800	5300	0.679	9100	10.0					
	2.0	2.0	4.5	65/55	5200	4700	0.683	7500	7.6					
		2.0	4.5	70/59	5700	4700	0.679	8000	8.4					
		2.0	4.5	75/63	6300	5000	0.675	8600	9.3					
		2.0	4.5	80/67	6800	5300	0.671	9100	10.1					
2.0	2.0	4.5	85/71	7400	5600	0.666	9700	11.1						

Size 009 (300 CFM) (continued)

EWT (°F)	GPM	WPD		EAT (°F)	Cooling					Heating				
		PSI	FT of W.C.		Total (Btu/hr)	Sensible (Btu/hr)	Power Input (kW)	THR (Btu/hr)	EER	Total (Btu/hr)	Power Input (kW)	THA (Btu/hr)	LAT (°F)	COP
70	1.5	1.3	3.0	65/55	8900	7200	0.582	10900	15.3	12800	0.659	10500	100	5.69
		1.3	3.0	70/59	9600	7300	0.577	11600	16.6	12600	0.681	10300	103	5.42
		1.3	3.0	75/63	10300	7600	0.573	12300	18.0	12400	0.709	10000	108	5.12
		1.3	3.0	80/67	11000	8000	0.568	12900	19.4	12200	0.737	9700	112	4.85
	2.3	2.6	5.8	65/55	9000	7300	0.565	10900	15.9	13000	0.662	10700	100	5.75
		2.6	5.8	70/59	9700	7400	0.560	11600	17.3	12800	0.684	10500	104	5.48
		2.6	5.8	75/63	10400	7700	0.556	12300	18.7	12600	0.712	10200	108	5.18
		2.6	5.8	80/67	11100	8100	0.551	13000	20.1	12400	0.739	9900	113	4.91
	3.0	4.1	9.3	65/55	9100	7400	0.547	11000	16.6	13200	0.665	10900	101	5.82
		4.1	9.3	70/59	9800	7400	0.543	11700	18.0	13000	0.687	10700	104	5.54
		4.1	9.3	75/63	10500	7800	0.539	12300	19.5	12800	0.714	10400	109	5.25
		4.1	9.3	80/67	11200	8200	0.534	13000	21.0	12600	0.742	10100	113	4.97
80	1.5	1.3	3.0	65/55	8400	7000	0.649	10600	12.9	14000	0.666	11700	103	6.16
		1.3	3.0	70/59	9100	7100	0.644	11300	14.1	13800	0.688	11500	106	5.87
		1.3	3.0	75/63	9800	7400	0.640	12000	15.3	13600	0.716	11200	111	5.56
		1.3	3.0	80/67	10500	7800	0.635	12700	16.5	13400	0.743	10900	115	5.28
	2.3	2.5	5.7	65/55	8500	7100	0.632	10700	13.5	14200	0.669	11900	103	6.22
		2.5	5.7	70/59	9200	7100	0.627	11300	14.7	14000	0.691	11600	107	5.94
		2.5	5.7	75/63	9900	7500	0.623	12000	15.9	13800	0.718	11300	111	5.63
		2.5	5.7	80/67	10600	7900	0.618	12700	17.1	13600	0.746	11100	116	5.34
	3.0	4.0	9.1	65/55	8600	7100	0.615	10700	14.0	14400	0.671	12100	104	6.28
		4.0	9.1	70/59	9300	7200	0.610	11400	15.2	14200	0.693	11800	107	6.00
		4.0	9.1	75/63	10000	7600	0.606	12100	16.5	14000	0.721	11500	112	5.68
		4.0	9.1	80/67	10700	7900	0.601	12800	17.8	13800	0.749	11200	116	5.40
90	1.5	1.3	2.9	65/55	7700	6900	0.718	10200	10.7	15100	0.668	12800	106	6.61
		1.3	2.9	70/59	8400	6900	0.713	10800	11.8	15000	0.691	12600	109	6.36
		1.3	2.9	75/63	9100	7300	0.709	11500	12.8	14700	0.718	12200	114	5.99
		1.3	2.9	80/67	9800	7700	0.704	12200	13.9	14500	0.746	12000	118	5.69
	2.3	2.5	5.6	65/55	7800	6900	0.701	10200	11.1	15400	0.671	13100	107	6.72
		2.5	5.6	70/59	8500	7000	0.696	10900	12.2	15200	0.693	12800	110	6.42
		2.5	5.6	75/63	9200	7400	0.692	11600	13.3	15000	0.721	12500	114	6.09
		2.5	5.6	80/67	9900	7700	0.687	12200	14.4	14700	0.749	12100	119	5.75
	3.0	3.9	8.9	65/55	7900	7000	0.683	10200	11.6	15600	0.674	13300	107	6.78
		3.9	8.9	70/59	8600	7100	0.679	10900	12.7	15400	0.696	13000	111	6.48
		3.9	8.9	75/63	9300	7400	0.675	11600	13.8	15200	0.724	12700	115	6.15
		3.9	8.9	80/67	10000	7800	0.670	12300	14.9	14900	0.751	12300	119	5.81
100	1.5	1.3	2.9	65/55	7000	6700	0.790	9700	8.9	Tint = Operation Not Recommended Notes: 1. Operation below 40°F EWT is based upon a 15% methanol anti-freeze solution. 2. Performance stated is at the rated power supply; performance may vary as the power supply varies from the rated. 3. See performance correction tables for operating conditions other than those listed. 4. Interpolation is permissible; extrapolation is not. 5. For performance data outside the EAT listed, refer to the Daikin SelectTools selection program. 6. Table does not reflect fan or pump power corrections for AHR/ISO conditions. 7. Data is base on unit at full load operation.				
		1.3	2.9	70/59	7700	6800	0.785	10400	9.8					
		1.3	2.9	75/63	8400	7100	0.781	11100	10.8					
		1.3	2.9	80/67	9100	7500	0.776	11800	11.7					
	2.3	2.4	5.6	65/55	7100	6800	0.773	9700	9.2					
		2.4	5.6	70/59	7800	6800	0.768	10400	10.2					
		2.4	5.6	75/63	8500	7200	0.764	11100	11.1					
		2.4	5.6	80/67	9200	7600	0.759	11800	12.1					
	3.0	3.9	8.8	65/55	7200	6900	0.756	9800	9.5					
		3.9	8.8	70/59	7900	6900	0.751	10500	10.5					
		3.9	8.8	75/63	8600	7300	0.747	11200	11.5					
		3.9	8.8	80/67	9300	7700	0.742	11800	12.5					
110	1.5	1.3	2.9	65/55	6400	6300	0.870	9400	7.4					
		1.3	2.9	70/59	7100	6300	0.866	10100	8.2					
		1.3	2.9	75/63	7800	6700	0.861	10700	9.1					
		1.3	2.9	80/67	8500	7100	0.857	11400	9.9					
	2.3	2.4	5.5	65/55	6500	6400	0.853	9400	7.6					
		2.4	5.5	70/59	7200	6400	0.849	10100	8.5					
		2.4	5.5	75/63	7900	6800	0.844	10800	9.4					
		2.4	5.5	80/67	8600	7200	0.840	11500	10.2					
	3.0	3.8	8.7	65/55	6600	6400	0.836	9500	7.9					
		3.8	8.7	70/59	7300	6500	0.832	10100	8.8					
		3.8	8.7	75/63	8000	6900	0.827	10800	9.7					
		3.8	8.7	80/67	8700	7200	0.823	11500	10.6					
3.8	8.7	85/71	9400	7600	0.818	12200	11.5							

Size 012 (400 CFM)

EWT (°F)	GPM	WPD		EAT (°F)	Cooling					Heating					
		PSI	FT OF W.C.		Total (Btu/hr)	Sensible (Btu/hr)	Power Input (kW)	THR (Btu/hr)	EER	Total (Btu/hr)	Power Input (kW)	THA (Btu/hr)	LAT (°F)	COP	
20	2.0	2.4	5.5	65/55	Tint = Operation Not Recommended (See "Appendix-A" on page 87 for table legend.)					8500	0.741	6000	86	3.36	
		2.4	5.5	70/59						8300	0.770	5700	89	3.15	
		2.4	5.5	75/63						8100	0.807	5300	94	2.94	
		2.4	5.5	80/67						7900	0.844	5000	98	2.74	
	3.0	4.6	10.6	65/55						8700	0.742	6200	86	3.43	
		4.6	10.6	70/59						8500	0.771	5900	90	3.23	
		4.6	10.6	75/63						8300	0.808	5500	94	3.01	
		4.6	10.6	80/67						8000	0.844	5100	98	2.77	
	4.0	7.4	16.8	65/55						8800	0.743	6300	86	3.47	
		7.4	16.8	70/59						8700	0.772	6100	90	3.30	
		7.4	16.8	75/63						8400	0.809	5600	94	3.04	
		7.4	16.8	80/67						8200	0.845	5300	99	2.84	
	30	2.0	2.3	5.4						65/55	9800	0.773	7200	89	3.71
			2.3	5.4						70/59	9700	0.802	7000	92	3.54
			2.3	5.4						75/63	13500	0.920	9600	101	3.28
			2.3	5.4						80/67	14900	1.000	10600	110	3.08
3.0		4.5	10.3	65/55	15700	1.050	11000	105	3.35						
		4.5	10.3	70/59	15200	1.080	10500	108	3.17						
		4.5	10.3	75/63	14000	0.940	9400	102	3.14						
		4.5	10.3	80/67	14700	0.980	10000	107	2.94						
4.0		7.1	16.3	65/55	15400	1.020	10400	105	3.39						
		7.1	16.3	70/59	12300	0.870	8700	98	3.85						
		7.1	16.3	75/63	13000	0.910	9100	102	3.64						
		7.1	16.3	80/67	13700	0.950	9500	106	3.41						
40		2.0	2.3	5.2	65/55	12800	0.920	9600	101	3.17					
			2.3	5.2	70/59	12800	0.920	9600	101	3.17					
			2.3	5.2	75/63	12800	0.920	9600	101	3.17					
			2.3	5.2	80/67	12800	0.920	9600	101	3.17					
	3.0	4.4	10.0	65/55	12800	0.920	9600	101	3.17						
		4.4	10.0	70/59	12800	0.920	9600	101	3.17						
		4.4	10.0	75/63	12800	0.920	9600	101	3.17						
		4.4	10.0	80/67	12800	0.920	9600	101	3.17						
	4.0	6.9	15.8	65/55	12800	0.920	9600	101	3.17						
		6.9	15.8	70/59	12800	0.920	9600	101	3.17						
		6.9	15.8	75/63	12800	0.920	9600	101	3.17						
		6.9	15.8	80/67	12800	0.920	9600	101	3.17						
	50	2.0	2.2	5.1	65/55	12600	0.930	9300	102	3.14					
			2.2	5.1	70/59	13300	0.930	9300	102	3.14					
			2.2	5.1	75/63	14000	0.930	9300	102	3.14					
			2.2	5.1	80/67	14700	0.930	9300	102	3.14					
3.0		4.2	9.7	65/55	12300	0.900	9000	100	3.40						
		4.2	9.7	70/59	13000	0.900	9000	100	3.40						
		4.2	9.7	75/63	13700	0.900	9000	100	3.40						
		4.2	9.7	80/67	14500	0.900	9000	100	3.40						
4.0		6.7	15.4	65/55	12000	0.880	8800	100	3.96						
		6.7	15.4	70/59	12800	0.880	8800	100	3.96						
		6.7	15.4	75/63	13500	0.880	8800	100	3.96						
		6.7	15.4	80/67	14200	0.880	8800	100	3.96						
60		2.0	2.2	4.9	65/55	12300	0.920	9200	101	3.17					
			2.2	4.9	70/59	13000	0.920	9200	101	3.17					
			2.2	4.9	75/63	13700	0.920	9200	101	3.17					
			2.2	4.9	80/67	14400	0.920	9200	101	3.17					
	3.0	4.1	9.5	65/55	12000	0.890	8900	100	4.06						
		4.1	9.5	70/59	12700	0.890	8900	100	4.06						
		4.1	9.5	75/63	13400	0.890	8900	100	4.06						
		4.1	9.5	80/67	14100	0.890	8900	100	4.06						
	4.0	6.6	15.0	65/55	11700	0.870	8700	100	5.09						
		6.6	15.0	70/59	12400	0.870	8700	100	5.09						
		6.6	15.0	75/63	13200	0.870	8700	100	5.09						
		6.6	15.0	80/67	13900	0.870	8700	100	5.09						

Size 012 (400 CFM) (continued)

EWT (°F)	GPM	WPD		EAT (°F)	Cooling					Heating										
		PSI	FT of W.C.		Total (Btu/hr)	Sensible (Btu/hr)	Power Input (kW)	THR (Btu/hr)	EER	Total (Btu/hr)	Power Input (kW)	THA (Btu/hr)	LAT (°F)	COP						
70	2.0	2.1	4.8	65/55	11800	9000	0.746	14300	15.8	16100	0.870	13100	103	5.42						
		2.1	4.8	70/59	12500	9000	0.741	15000	16.9	15900	0.899	12800	107	5.18						
		2.1	4.8	75/63	13200	9500	0.735	15700	18.0	15700	0.936	12500	111	4.91						
		2.1	4.8	80/67	13900	9900	0.729	16400	19.1	15500	0.972	12200	116	4.67						
	3.0	4.1	9.3	65/55	11500	8800	0.731	14000	15.7	16300	0.871	13300	104	5.48						
		4.1	9.3	70/59	12200	8800	0.726	14700	16.8	16100	0.900	13000	107	5.24						
		4.1	9.3	75/63	13000	9200	0.720	15500	18.1	15900	0.936	12700	112	4.97						
		4.1	9.3	80/67	13700	9700	0.714	16100	19.2	15600	0.973	12300	116	4.69						
	4.0	6.4	14.7	65/55	11300	8500	0.716	13700	15.8	16400	0.871	13400	104	5.51						
		6.4	14.7	70/59	12000	8600	0.711	14400	16.9	16300	0.901	13200	108	5.30						
		6.4	14.7	75/63	12700	9000	0.705	15100	18.0	16000	0.937	12800	112	5.00						
		6.4	14.7	80/67	13400	9400	0.699	15800	19.2	15800	0.974	12500	116	4.75						
	80	2.0	2.1	4.7	65/55	11200	8800	0.831	14000	13.5	17700	0.886	14700	107	5.85					
			2.1	4.7	70/59	11900	8800	0.826	14700	14.4	17500	0.915	14400	110	5.60					
			2.1	4.7	75/63	12600	9200	0.820	15400	15.4	17300	0.952	14000	115	5.32					
			2.1	4.7	80/67	13300	9700	0.814	16100	16.3	17000	0.988	13600	119	5.04					
3.0		4.0	9.1	65/55	10900	8500	0.816	13700	13.4	17800	0.887	14800	107	5.88						
		4.0	9.1	70/59	11600	8600	0.811	14400	14.3	17600	0.916	14500	111	5.63						
		4.0	9.1	75/63	12400	9000	0.805	15100	15.4	17400	0.953	14100	115	5.35						
		4.0	9.1	80/67	13100	9400	0.799	15800	16.4	17200	0.989	13800	120	5.09						
4.0		6.3	14.4	65/55	10700	8300	0.801	13400	13.4	18000	0.888	15000	107	5.94						
		6.3	14.4	70/59	11400	8300	0.796	14100	14.3	17800	0.917	14700	111	5.68						
		6.3	14.4	75/63	12100	8700	0.790	14800	15.3	17600	0.953	14300	116	5.40						
		6.3	14.4	80/67	12800	9200	0.784	15500	16.3	17400	0.990	14000	120	5.15						
90		2.0	2.0	4.7	65/55	10400	8400	0.924	13600	11.2	19100	0.899	16000	110	6.22					
			2.0	4.7	70/59	11100	8500	0.919	14200	12.1	18900	0.928	15700	114	5.96					
			2.0	4.7	75/63	11900	8900	0.913	15000	13.0	18700	0.965	15400	118	5.67					
			2.0	4.7	80/67	12600	9300	0.907	15700	13.9	18500	1.002	15100	123	5.41					
	3.0	3.9	8.9	65/55	10200	8200	0.909	13300	11.2	19300	0.900	16200	110	6.28						
		3.9	8.9	70/59	10900	8200	0.904	14000	12.1	19100	0.929	15900	114	6.02						
		3.9	8.9	75/63	11600	8600	0.898	14700	12.9	18900	0.966	15600	119	5.73						
		3.9	8.9	80/67	12300	9100	0.892	15300	13.8	18700	1.002	15300	123	5.46						
	4.0	6.2	14.2	65/55	9900	8000	0.894	13000	11.1	19500	0.901	16400	111	6.34						
		6.2	14.2	70/59	10600	8000	0.889	13600	11.9	19300	0.930	16100	114	6.08						
		6.2	14.2	75/63	11300	8400	0.883	14300	12.8	19100	0.967	15800	119	5.79						
		6.2	14.2	80/67	12100	8800	0.877	15100	13.8	18800	1.003	15400	123	5.49						
	100	2.0	2.0	4.6	65/55	9600	8000	1.026	13100	9.4	Tint = Operation Not Recommended Notes: 1. Operation below 40°F EWT is based upon a 15% methanol anti-freeze solution. 2. Performance stated is at the rated power supply; performance may vary as the power supply varies from the rated. 3. See performance correction tables for operating conditions other than those listed. 4. Interpolation is permissible; extrapolation is not. 5. For performance data outside the EAT listed, refer to the Daikin SelectTools selection program. 6. Table does not reflect fan or pump power corrections for AHR/ISO conditions. 7. Data is base on unit at full load operation.									
			2.0	4.6	70/59	10300	8000	1.021	13800	10.1										
			2.0	4.6	75/63	11000	8500	1.015	14500	10.8										
			2.0	4.6	80/67	11700	8900	1.009	15100	11.6										
3.0		3.9	8.8	65/55	9300	7800	1.011	12800	9.2											
		3.9	8.8	70/59	10000	7800	1.006	13400	9.9											
		3.9	8.8	75/63	10700	8200	1.000	14100	10.7											
		3.9	8.8	80/67	11400	8700	0.994	14800	11.5											
4.0		6.1	14.0	65/55	9000	7500	0.996	12400	9.0											
		6.1	14.0	70/59	9700	7600	0.991	13100	9.8											
		6.1	14.0	75/63	10500	8000	0.985	13900	10.7											
		6.1	14.0	80/67	11200	8400	0.979	14500	11.4											
110		2.0	2.0	4.5	65/55	8500	7500	1.136	12400	7.5						Tint = Operation Not Recommended Notes: 1. Operation below 40°F EWT is based upon a 15% methanol anti-freeze solution. 2. Performance stated is at the rated power supply; performance may vary as the power supply varies from the rated. 3. See performance correction tables for operating conditions other than those listed. 4. Interpolation is permissible; extrapolation is not. 5. For performance data outside the EAT listed, refer to the Daikin SelectTools selection program. 6. Table does not reflect fan or pump power corrections for AHR/ISO conditions. 7. Data is base on unit at full load operation.				
			2.0	4.5	70/59	9200	7500	1.131	13100	8.1										
			2.0	4.5	75/63	10000	8000	1.125	13800	8.9										
			2.0	4.5	80/67	10700	8400	1.119	14500	9.6										
	3.0	3.8	8.7	65/55	8300	7300	1.121	12100	7.4											
		3.8	8.7	70/59	9000	7300	1.116	12800	8.1											
		3.8	8.7	75/63	9700	7700	1.110	13500	8.7											
		3.8	8.7	80/67	10400	8200	1.104	14200	9.4											
	4.0	6.1	13.8	65/55	8000	7000	1.106	11800	7.2											
		6.1	13.8	70/59	8700	7000	1.101	12500	7.9											
		6.1	13.8	75/63	9400	7500	1.095	13100	8.6											
		6.1	13.8	80/67	10200	7900	1.089	13900	9.4											
	6.1	13.8	85/71	10900	8300	1.083	14600	10.1												

Size 015 (500 CFM)

EWT (°F)	GPM	WPD		EAT (°F)	Cooling					Heating									
		PSI	FT of W.C.		Total (Btu/hr)	Sensible (Btu/hr)	Power Input (kW)	THR (Btu/hr)	EER	Total (Btu/hr)	Power Input (kW)	THA (Btu/hr)	LAT (°F)	COP					
20	2.5	1.3	2.9	65/55	Tint = Operation Not Recommended (See "Appendix-A" on page 87 for table legend.)					9300	0.801	6600	83	3.40					
		1.3	2.9	70/59						9100	0.835	6200	87	3.19					
		1.3	2.9	75/63						8800	0.878	5800	91	2.94					
		1.3	2.9	80/67						8600	0.921	5500	96	2.74					
		1.3	2.9	85/71															
	3.8	2.8	6.4	65/55											9900	0.805	7200	84	3.60
		2.8	6.4	70/59											9700	0.839	6800	88	3.38
		2.8	6.4	75/63											9400	0.882	6400	92	3.12
		2.8	6.4	80/67											9200	0.925	6000	97	2.91
		2.8	6.4	85/71															
	5.0	5.0	11.3	65/55											10500	0.809	7700	85	3.80
		5.0	11.3	70/59											10300	0.843	7400	89	3.58
		5.0	11.3	75/63											10000	0.886	7000	93	3.30
		5.0	11.3	80/67											9800	0.929	6600	98	3.09
		5.0	11.3	85/71															
30	2.5	1.2	2.8	65/55						11100	0.874	8100	86	3.72					
		1.2	2.8	70/59	14900	10200	0.513	16700	29.1	10900	0.909	7800	90	3.51					
		1.2	2.8	75/63	15800	10800	0.508	17500	31.1	10600	0.951	7400	95	3.26					
		1.2	2.8	80/67	16600	11300	0.502	18300	33.0	10300	0.994	6900	99	3.03					
		1.2	2.8	85/71	17500	11800	0.497	19200	35.2										
	3.8	2.7	6.2	65/55	14400	10400	0.484	16100	29.7	11700	0.879	8700	88	3.90					
		2.7	6.2	70/59	15200	10400	0.479	16800	31.7	11500	0.913	8400	91	3.69					
		2.7	6.2	75/63	16100	10900	0.474	17700	34.0	11200	0.955	7900	96	3.43					
		2.7	6.2	80/67	17000	11500	0.469	18600	36.3	10900	0.998	7500	100	3.20					
		2.7	6.2	85/71	17800	12000	0.463	19400	38.4										
	5.0	4.8	11.0	65/55	14800	10500	0.450	16300	32.9	12300	0.883	9300	89	4.08					
		4.8	11.0	70/59	15600	10600	0.445	17100	35.0	12100	0.917	9000	92	3.86					
		4.8	11.0	75/63	16500	11100	0.440	18000	37.5	11800	0.960	8500	97	3.60					
		4.8	11.0	80/67	17300	11600	0.435	18800	39.8	11500	1.002	8100	101	3.36					
		4.8	11.0	85/71	18200	12200	0.429	19700	42.4										
40	2.5	1.2	2.7	65/55	14100	10400	0.580	16100	24.3	13000	0.926	9800	90	4.11					
		1.2	2.7	70/59	15000	10400	0.575	17000	26.1	12800	0.961	9500	94	3.90					
		1.2	2.7	75/63	15800	10900	0.569	17700	27.7	12500	1.003	9100	98	3.65					
		1.2	2.7	80/67	16700	11500	0.564	18600	29.6	12300	1.046	8700	103	3.44					
		1.2	2.7	85/71	17500	12000	0.559	19400	31.3										
	3.8	2.6	6.0	65/55	14500	10600	0.546	16400	26.6	13600	0.930	10400	91	4.28					
		2.6	6.0	70/59	15300	10600	0.541	17100	28.3	13400	0.965	10100	95	4.07					
		2.6	6.0	75/63	16200	11100	0.536	18000	30.2	13100	1.007	9700	99	3.81					
		2.6	6.0	80/67	17000	11700	0.530	18800	32.1	12900	1.050	9300	104	3.60					
		2.6	6.0	85/71	17900	12200	0.525	19700	34.1										
	5.0	4.7	10.6	65/55	14800	10700	0.512	16500	28.9	14200	0.935	11000	92	4.45					
		4.7	10.6	70/59	15700	10800	0.507	17400	31.0	14000	0.969	10700	96	4.23					
		4.7	10.6	75/63	16500	11300	0.502	18200	32.9	13700	1.012	10200	100	3.97					
		4.7	10.6	80/67	17400	11800	0.496	19100	35.0	13500	1.054	9900	105	3.75					
		4.7	10.6	85/71	18200	12400	0.491	19900	37.1										
50	2.5	1.2	2.6	65/55	14000	10500	0.650	16200	21.5	15000	0.961	11700	94	4.57					
		1.2	2.6	70/59	14900	10500	0.645	17100	23.1	14800	0.996	11400	97	4.35					
		1.2	2.6	75/63	15700	11000	0.639	17900	24.6	14600	1.038	11100	102	4.12					
		1.2	2.6	80/67	16600	11600	0.634	18800	26.2	14300	1.081	10600	106	3.87					
		1.2	2.6	85/71	17400	12100	0.629	19500	27.7										
	3.8	2.6	5.9	65/55	14400	10700	0.616	16500	23.4	15600	0.966	12300	95	4.73					
		2.6	5.9	70/59	15200	10700	0.611	17300	24.9	15400	1.000	12000	98	4.51					
		2.6	5.9	75/63	16100	11200	0.605	18200	26.6	15200	1.043	11600	103	4.27					
		2.6	5.9	80/67	16900	11700	0.600	18900	28.2	14900	1.085	11200	107	4.02					
		2.6	5.9	85/71	17800	12300	0.595	19800	29.9										
	5.0	4.5	10.4	65/55	14700	10800	0.582	16700	25.3	16200	0.970	12900	96	4.89					
		4.5	10.4	70/59	15600	10900	0.577	17600	27.0	16000	1.004	12600	99	4.67					
		4.5	10.4	75/63	16400	11400	0.572	18400	28.7	15800	1.047	12200	104	4.42					
		4.5	10.4	80/67	17300	11900	0.566	19200	30.5	15500	1.089	11800	109	4.17					
		4.5	10.4	85/71	18100	12400	0.561	20000	32.3										
60	2.5	1.1	2.6	65/55	13800	10500	0.728	16300	19.0	17200	0.984	13800	98	5.12					
		1.1	2.6	70/59	14600	10500	0.723	17100	20.2	16900	1.019	13400	101	4.86					
		1.1	2.6	75/63	15400	11000	0.717	17800	21.5	16700	1.061	13100	106	4.61					
		1.1	2.6	80/67	16300	11600	0.712	18700	22.9	16400	1.104	12600	110	4.35					
		1.1	2.6	85/71	17100	12100	0.707	19500	24.2										
	3.8	2.5	5.7	65/55	14100	10700	0.694	16500	20.3	17800	0.989	14400	99	5.27					
		2.5	5.7	70/59	14900	10700	0.689	17300	21.6	17500	1.023	14000	102	5.01					
		2.5	5.7	75/63	15800	11200	0.683	18100	23.1	17300	1.065	13700	107	4.75					
		2.5	5.7	80/67	16600	11700	0.678	18900	24.5	17000	1.108	13200	111	4.49					
		2.5	5.7	85/71	17500	12300	0.673	19800	26.0										
	5.0	4.4	10.1	65/55	14500	10800	0.660	16800	22.0	18300	0.993	14900	100	5.40					
		4.4	10.1	70/59	15300	10900	0.655	17500	23.4	18100	1.027	14600	103	5.16					
		4.4	10.1	75/63	16100	11400	0.650	18300	24.8	17900	1.070	14200	108	4.90					
		4.4	10.1	80/67	17000	11900	0.644	19200	26.4	17600	1.112	13800	112	4.63					
		4.4	10.1	85/71	17800	12400	0.639	20000	27.9										

Size 015 (500 CFM) (continued)

EWT (°F)	GPM	WPD		EAT (°F)	Cooling					Heating					
		PSI	FT of W.C.		Total (Btu/hr)	Sensible (Btu/hr)	Power Input (kW)	THR (Btu/hr)	EER	Total (Btu/hr)	Power Input (kW)	THA (Btu/hr)	LAT (°F)	COP	
70	2.5	1.1	2.5	65/55	13300	10400	0.814	16100	16.3	19300	1.000	15900	102	5.65	
		1.1	2.5	70/59	14100	10400	0.809	16900	17.4	19100	1.034	15600	105	5.41	
		1.1	2.5	75/63	15000	10900	0.803	17700	18.7	18800	1.077	15100	110	5.11	
		1.1	2.5	80/67	15800	11500	0.798	18500	19.8	18600	1.119	14800	114	4.87	
	3.8	2.5	5.6	65/55	13700	10600	0.780	16400	17.6	19900	1.004	16500	103	5.80	
		2.5	5.6	70/59	14500	10600	0.775	17100	18.7	19700	1.038	16200	106	5.56	
		2.5	5.6	75/63	15300	11100	0.770	17900	19.9	19400	1.081	15700	111	5.26	
		2.5	5.6	80/67	16200	11600	0.764	18800	21.2	19100	1.124	15300	115	4.98	
	5.0	2.5	5.6	85/71	17000	12200	0.759	19600	22.4						
		4.3	9.9	65/55	14000	10700	0.746	16500	18.8	20500	1.008	17100	104	5.96	
		4.3	9.9	70/59	14800	10800	0.741	17300	20.0	20300	1.042	16700	107	5.70	
		4.3	9.9	75/63	15700	11300	0.736	18200	21.3	20000	1.085	16300	112	5.40	
80	2.5	4.3	9.9	80/67	16500	11800	0.731	19000	22.6	19700	1.128	15800	116	5.12	
		4.3	9.9	85/71	17400	12300	0.725	19900	24.0						
		1.1	2.5	65/55	12700	10200	0.908	15800	14.0	21400	1.012	17900	105	6.19	
		1.1	2.5	70/59	13500	10200	0.903	16600	15.0	21200	1.046	17600	109	5.93	
	3.8	1.1	2.5	75/63	14400	10700	0.898	17500	16.0	20900	1.089	17200	113	5.62	
		1.1	2.5	80/67	15200	11300	0.892	18200	17.0	20700	1.132	16800	118	5.36	
		1.1	2.5	85/71	16100	11800	0.887	19100	18.1						
		2.4	5.5	65/55	13000	10400	0.874	16000	14.9	22000	1.016	18500	107	6.34	
	5.0	2.4	5.5	70/59	13900	10400	0.869	16900	16.0	21800	1.050	18200	110	6.08	
		2.4	5.5	75/63	14700	10900	0.864	17700	17.0	21500	1.093	17800	115	5.76	
		2.4	5.5	80/67	15600	11500	0.859	18500	18.2	21300	1.136	17400	119	5.49	
		2.4	5.5	85/71	16400	12000	0.853	19300	19.2						
90	2.5	4.3	9.7	65/55	13400	10500	0.841	16300	15.9	22600	1.020	19100	108	6.49	
		4.3	9.7	70/59	14200	10600	0.835	17100	17.0	22400	1.055	18800	111	6.22	
		4.3	9.7	75/63	15100	11100	0.830	17900	18.2	22100	1.097	18400	116	5.90	
		4.3	9.7	80/67	15900	11600	0.825	18700	19.3	21800	1.140	17900	120	5.60	
	3.8	4.3	9.7	85/71	16800	12200	0.820	19600	20.5						
		1.1	2.4	65/55	11900	9900	1.011	15400	11.8	23400	1.026	19900	109	6.68	
		1.1	2.4	70/59	12700	9900	1.005	16100	12.6	23200	1.060	19600	113	6.41	
		1.1	2.4	75/63	13600	10500	1.000	17000	13.6	22900	1.103	19100	117	6.08	
	5.0	1.1	2.4	80/67	14400	11000	0.995	17800	14.5	22700	1.146	18800	122	5.80	
		1.1	2.4	85/71	15300	11500	0.990	18700	15.5						
		2.4	5.4	65/55	12200	10100	0.977	15500	12.5	24000	1.030	20500	110	6.82	
		2.4	5.4	70/59	13000	10100	0.972	16300	13.4	23800	1.064	20200	114	6.55	
100	2.5	2.4	5.4	75/63	13900	10600	0.966	17200	14.4	23500	1.107	19700	118	6.22	
		2.4	5.4	80/67	14800	11200	0.961	18100	15.4	23300	1.150	19400	123	5.93	
		2.4	5.4	85/71	15600	11700	0.956	18900	16.3						
		4.2	9.6	65/55	12600	10200	0.943	15800	13.4	24600	1.034	21100	111	6.96	
	3.8	4.2	9.6	70/59	13400	10300	0.938	16600	14.3	24400	1.068	20800	115	6.69	
		4.2	9.6	75/63	14200	10800	0.933	17400	15.2	24100	1.111	20300	119	6.35	
		4.2	9.6	80/67	15100	11300	0.927	18300	16.3	23900	1.154	20000	124	6.06	
		4.2	9.6	85/71	16000	11900	0.922	19100	17.4						
	110	2.5	1.1	2.4	65/55	10900	9500	1.121	14700	9.7	Tint = Operation Not Recommended Notes: 1. Operation below 40°F EWT is based upon a 15% methanol anti-freeze solution. 2. Performance stated is at the rated power supply; performance may vary as the power supply varies from the rated. 3. See performance correction tables for operating conditions other than those listed. 4. Interpolation is permissible; extrapolation is not. 5. For performance data outside the EAT listed, refer to the Daikin SelectTools selection program. 6. Table does not reflect fan or pump power corrections for AHR/ISO conditions. 7. Data is base on unit at full load operation.				
			1.1	2.4	70/59	11700	9500	1.116	15500	10.5					
			1.1	2.4	75/63	12600	10100	1.111	16400	11.3					
			1.1	2.4	80/67	13400	10600	1.105	17200	12.1					
3.8		1.1	2.4	85/71	14300	11100	1.100	18100	13.0						
		2.3	5.4	65/55	11200	9700	1.087	14900	10.3						
		2.3	5.4	70/59	12100	9700	1.082	15800	11.2						
		2.3	5.4	75/63	12900	10200	1.077	16600	12.0						
5.0		2.3	5.4	80/67	13800	10800	1.072	17500	12.9						
		2.3	5.4	85/71	14600	11300	1.066	18200	13.7						
		4.1	9.4	65/55	11600	9900	1.054	15200	11.0						
		4.1	9.4	70/59	12400	9900	1.048	16000	11.8						
120	2.5	4.1	9.4	75/63	13300	10400	1.043	16900	12.8						
		4.1	9.4	80/67	14100	11000	1.038	17600	13.6						
		4.1	9.4	85/71	15000	11500	1.033	18500	14.5						
		1.0	2.4	65/55	9700	9000	1.240	13900	7.8						
	3.8	1.0	2.4	70/59	10600	9100	1.235	14800	8.6						
		1.0	2.4	75/63	11400	9600	1.229	15600	9.3						
		1.0	2.4	80/67	12300	10100	1.224	16500	10.0						
		1.0	2.4	85/71	13100	10700	1.219	17300	10.7						
	5.0	2.3	5.3	65/55	10100	9200	1.206	14200	8.4						
		2.3	5.3	70/59	10900	9200	1.201	15000	9.1						
		2.3	5.3	75/63	11800	9800	1.196	15900	9.9						
		2.3	5.3	80/67	12600	10300	1.190	16700	10.6						
5.0	2.3	5.3	85/71	13500	10800	1.185	17500	11.4							
	4.1	9.3	65/55	10400	9400	1.172	14400	8.9							
	4.1	9.3	70/59	11300	9400	1.167	15300	9.7							
	4.1	9.3	75/63	12100	9900	1.162	16100	10.4							
5.0	4.1	9.3	80/67	13000	10500	1.157	16900	11.2							
	4.1	9.3	85/71	13800	11000	1.151	17700	12.0							

Size 019 (600 CFM)

EWT (°F)	GPM	WPD		EAT (°F)	Cooling					Heating				
		PSI	FT of W.C.		Total (Btu/hr)	Sensible (Btu/hr)	Power Input (kW)	THR (Btu/hr)	EER	Total (Btu/hr)	Power Input (kW)	THA (Btu/hr)	LAT (°F)	COP
20	3.0	1.8	4.0	65/55	Tint = Operation Not Recommended (See "Appendix-A" on page 87 for table legend.)					10600	0.906	7500	82	3.43
		1.8	4.0	70/59						10300	0.946	7100	86	3.19
		1.8	4.0	75/63						10100	0.996	6700	91	2.97
		1.8	4.0	80/67						9800	1.045	6200	95	2.74
		1.8	4.0	85/71										
	4.5	3.9	9.0	65/55						11000	0.921	7900	83	3.50
		3.9	9.0	70/59						10800	0.961	7500	87	3.29
		3.9	9.0	75/63						10500	1.011	7000	91	3.04
		3.9	9.0	80/67						10200	1.060	6600	96	2.82
		3.9	9.0	85/71										
	6.0	7.0	15.9	65/55						11400	0.936	8200	83	3.57
		7.0	15.9	70/59						11200	0.976	7900	87	3.36
		7.0	15.9	75/63						10900	1.026	7400	92	3.11
		7.0	15.9	80/67						10600	1.075	6900	96	2.89
		7.0	15.9	85/71										
30	3.0	1.7	3.9	65/55	13400	1.037	9900	87	3.78					
		1.7	3.9	70/59	13200	1.077	9500	90	3.59					
		1.7	3.9	75/63	12900	1.126	9100	95	3.35					
		1.7	3.9	80/67	12600	1.176	8600	99	3.14					
		1.7	3.9	85/71	22700	14500	0.599	24700	37.9					
	4.5	3.8	8.7	65/55	13800	1.052	10200	87	3.84					
		3.8	8.7	70/59	13600	1.092	9900	91	3.65					
		3.8	8.7	75/63	13300	1.141	9400	95	3.41					
		3.8	8.7	80/67	13000	1.191	8900	100	3.20					
		3.8	8.7	85/71	22900	14400	0.568	24800	40.3					
	6.0	6.7	15.4	65/55	14200	1.067	10600	88	3.90					
		6.7	15.4	70/59	14000	1.107	10200	91	3.70					
		6.7	15.4	75/63	13700	1.156	9800	96	3.47					
		6.7	15.4	80/67	13500	1.206	9400	101	3.28					
		6.7	15.4	85/71	23100	14200	0.536	24900	43.1					
40	3.0	1.7	3.8	65/55	15800	1.092	12100	90	4.24					
		1.7	3.8	70/59	15600	1.132	11700	94	4.03					
		1.7	3.8	75/63	15300	1.182	11300	98	3.79					
		1.7	3.8	80/67	15000	1.232	10800	103	3.57					
		1.7	3.8	85/71	21200	14700	0.668	23500	31.7					
	4.5	3.7	8.4	65/55	16200	1.107	12400	91	4.28					
		3.7	8.4	70/59	16000	1.147	12100	95	4.08					
		3.7	8.4	75/63	15700	1.197	11600	99	3.84					
		3.7	8.4	80/67	15400	1.247	11100	104	3.62					
		3.7	8.4	85/71	21400	14500	0.637	23600	33.6					
	6.0	6.5	14.9	65/55	16600	1.122	12800	91	4.33					
		6.5	14.9	70/59	16400	1.162	12400	95	4.13					
		6.5	14.9	75/63	16100	1.212	12000	100	3.89					
		6.5	14.9	80/67	15800	1.262	11500	104	3.67					
		6.5	14.9	85/71	21600	14400	0.605	23700	35.7					
50	3.0	1.6	3.7	65/55	18200	1.129	14300	94	4.72					
		1.6	3.7	70/59	17900	1.169	13900	97	4.48					
		1.6	3.7	75/63	17700	1.219	13500	102	4.25					
		1.6	3.7	80/67	17400	1.268	13100	107	4.02					
		1.6	3.7	85/71	20900	14700	0.747	23500	28.0					
	4.5	3.6	8.2	65/55	18600	1.144	14700	95	4.76					
		3.6	8.2	70/59	18300	1.184	14300	98	4.53					
		3.6	8.2	75/63	18100	1.233	13900	103	4.30					
		3.6	8.2	80/67	17800	1.283	13400	107	4.06					
		3.6	8.2	85/71	21100	14600	0.716	23500	29.5					
	6.0	6.4	14.5	65/55	19000	1.159	15000	95	4.80					
		6.4	14.5	70/59	18800	1.199	14700	99	4.59					
		6.4	14.5	75/63	18500	1.248	14200	103	4.34					
		6.4	14.5	80/67	18200	1.298	13800	108	4.10					
		6.4	14.5	85/71	21300	14400	0.684	23600	31.1					
60	3.0	1.6	3.6	65/55	20600	1.171	16600	98	5.15					
		1.6	3.6	70/59	20400	1.210	16300	101	4.94					
		1.6	3.6	75/63	20100	1.260	15800	106	4.67					
		1.6	3.6	80/67	19900	1.310	15400	111	4.45					
		1.6	3.6	85/71	20700	14600	0.836	23600	24.8					
	4.5	3.5	8.0	65/55	21100	1.185	17100	98	5.21					
		3.5	8.0	70/59	20800	1.225	16600	102	4.97					
		3.5	8.0	75/63	20600	1.275	16200	107	4.73					
		3.5	8.0	80/67	20300	1.325	15800	111	4.49					
		3.5	8.0	85/71	20900	14500	0.805	23600	26.0					
	6.0	6.2	14.2	65/55	21500	1.200	17400	99	5.24					
		6.2	14.2	70/59	21200	1.240	17000	103	5.01					
		6.2	14.2	75/63	21000	1.290	16600	107	4.77					
		6.2	14.2	80/67	20700	1.340	16100	112	4.52					
		6.2	14.2	85/71	21100	14300	0.773	23700	27.3					

Size 019 (600 CFM) (continued)

EWT (°F)	GPM	WPD		EAT (°F)	Cooling					Heating				
		PSI	FT of W.C.		Total (Btu/hr)	Sensible (Btu/hr)	Power Input (kW)	THR (Btu/hr)	EER	Total (Btu/hr)	Power Input (kW)	THA (Btu/hr)	LAT (°F)	COP
70	3.0	1.5	3.5	65/55	15800	12500	0.980	19100	16.1	23200	1.219	19000	102	5.57
		1.5	3.5	70/59	16900	12500	0.969	20200	17.4	23000	1.259	18700	105	5.35
		1.5	3.5	75/63	18000	13200	0.958	21300	18.8	22700	1.309	18200	110	5.08
		1.5	3.5	80/67	19100	13800	0.946	22300	20.2	22400	1.358	17800	114	4.83
	4.5	3.4	7.8	65/55	16000	12300	0.949	19200	16.9	23600	1.234	19400	102	5.60
		3.4	7.8	70/59	17100	12400	0.938	20300	18.2	23400	1.274	19000	106	5.38
		3.4	7.8	75/63	18200	13000	0.926	21400	19.6	23100	1.324	18600	110	5.11
		3.4	7.8	80/67	19300	13600	0.915	22400	21.1	22800	1.373	18100	115	4.86
	6.0	6.1	13.9	65/55	16200	12200	0.917	19300	17.7	24000	1.249	19700	103	5.63
		6.1	13.9	70/59	17300	12200	0.906	20400	19.1	23800	1.289	19400	107	5.41
		6.1	13.9	75/63	18400	12900	0.895	21500	20.6	23500	1.339	18900	111	5.14
		6.1	13.9	80/67	19400	13500	0.883	22400	22.0	23300	1.388	18600	116	4.91
80	3.0	1.5	3.4	65/55	14700	12100	1.089	18400	13.5	25700	1.265	21400	105	5.95
		1.5	3.4	70/59	15800	12200	1.078	19500	14.7	25500	1.305	21000	109	5.72
		1.5	3.4	75/63	16900	12800	1.067	20500	15.8	25200	1.355	20600	114	5.45
		1.5	3.4	80/67	18000	13400	1.055	21600	17.1	24900	1.405	20100	118	5.19
	4.5	3.4	7.7	65/55	14900	12000	1.058	18500	14.1	26100	1.280	21700	106	5.97
		3.4	7.7	70/59	16000	12000	1.047	19600	15.3	25900	1.320	21400	110	5.75
		3.4	7.7	75/63	17100	12600	1.035	20600	16.5	25600	1.370	20900	114	5.47
		3.4	7.7	80/67	18200	13300	1.024	21700	17.8	25300	1.420	20500	119	5.22
	6.0	6.0	13.6	65/55	15100	11800	1.026	18600	14.7	26500	1.295	22100	107	5.99
		6.0	13.6	70/59	16200	11900	1.015	19700	16.0	26300	1.335	21700	110	5.77
		6.0	13.6	75/63	17300	12500	1.004	20700	17.2	26000	1.385	21300	115	5.50
		6.0	13.6	80/67	18400	13100	0.992	21800	18.5	25700	1.434	20800	119	5.25
90	3.0	1.5	3.4	65/55	13400	11700	1.208	17500	11.1	28000	1.299	23600	109	6.31
		1.5	3.4	70/59	14500	11700	1.197	18600	12.1	27800	1.339	23200	113	6.08
		1.5	3.4	75/63	15600	12300	1.186	19600	13.2	27500	1.389	22800	117	5.80
		1.5	3.4	80/67	16700	12900	1.174	20700	14.2	27200	1.439	22300	122	5.54
	4.5	3.3	7.6	65/55	13600	11500	1.177	17600	11.6	28400	1.314	23900	110	6.33
		3.3	7.6	70/59	14700	11500	1.166	18700	12.6	28200	1.354	23600	113	6.10
		3.3	7.6	75/63	15800	12200	1.154	19700	13.7	27900	1.404	23100	118	5.82
		3.3	7.6	80/67	16900	12800	1.143	20800	14.8	27600	1.454	22600	122	5.56
	6.0	5.9	13.4	65/55	13800	11400	1.145	17700	12.0	28800	1.329	24300	110	6.34
		5.9	13.4	70/59	14900	11400	1.134	18800	13.1	28600	1.369	23900	114	6.12
		5.9	13.4	75/63	16000	12000	1.123	19800	14.3	28300	1.419	23500	118	5.84
		5.9	13.4	80/67	17100	12600	1.111	20900	15.4	28000	1.469	23000	123	5.58
100	3.0	1.5	3.3	65/55	12100	11000	1.337	16700	9.0	Tint = Operation Not Recommended Notes: 1. Operation below 40°F EWT is based upon a 15% methanol anti-freeze solution. 2. Performance stated is at the rated power supply; performance may vary as the power supply varies from the rated. 3. See performance correction tables for operating conditions other than those listed. 4. Interpolation is permissible; extrapolation is not. 5. For performance data outside the EAT listed, refer to the Daikin SelectTools selection program. 6. Table does not reflect fan or pump power corrections for AHR/ISO conditions. 7. Data is base on unit at full load operation.				
		1.5	3.3	70/59	13200	11100	1.326	17700	10.0					
		1.5	3.3	75/63	14300	11700	1.315	18800	10.9					
		1.5	3.3	80/67	15400	12300	1.303	19900	11.8					
	4.5	3.3	7.5	65/55	12300	10900	1.306	16800	9.4					
		3.3	7.5	70/59	13400	10900	1.295	17800	10.4					
		3.3	7.5	75/63	14500	11500	1.283	18900	11.3					
		3.3	7.5	80/67	15600	12200	1.272	19900	12.3					
	6.0	5.8	13.2	65/55	12500	10700	1.274	16900	9.8					
		5.8	13.2	70/59	13600	10800	1.263	17900	10.8					
		5.8	13.2	75/63	14700	11400	1.252	19000	11.7					
		5.8	13.2	80/67	15800	12000	1.240	20000	12.7					
110	3.0	1.4	3.3	65/55	11200	10300	1.476	16200	7.6					
		1.4	3.3	70/59	12300	10300	1.465	17300	8.4					
		1.4	3.3	75/63	13400	10900	1.454	18400	9.2					
		1.4	3.3	80/67	14500	11600	1.442	19400	10.1					
	4.5	3.2	7.4	65/55	11400	10100	1.445	16300	7.9					
		3.2	7.4	70/59	12500	10200	1.434	17400	8.7					
		3.2	7.4	75/63	13600	10800	1.422	18500	9.6					
		3.2	7.4	80/67	14700	11400	1.411	19500	10.4					
	6.0	5.7	13.1	65/55	11600	10000	1.413	16400	8.2					
		5.7	13.1	70/59	12700	10000	1.402	17500	9.1					
		5.7	13.1	75/63	13800	10600	1.391	18500	9.9					
		5.7	13.1	80/67	14900	11300	1.379	19600	10.8					

Size 024 (800 CFM)

EWT (°F)	GPM	WPD		EAT (°F)	Cooling					Heating									
		PSI	FT of W.C.		Total (Btu/hr)	Sensible (Btu/hr)	Power Input (kW)	THR (Btu/hr)	EER	Total (Btu/hr)	Power Input (kW)	THA (Btu/hr)	LAT (°F)	COP					
20	4.0	1.2	2.7	65/55	Tint = Operation Not Recommended (See "Appendix-A" on page 87 for table legend.)						14600	1.293	10200	83	3.31				
		1.2	2.7	70/59							14500	1.347	9900	87	3.15				
		1.2	2.7	75/63							14200	1.415	9400	91	2.94				
		1.2	2.7	80/67							14000	1.482	8900	96	2.77				
	6.0	2.5	5.7	65/55							15200	1.304	10700	83	3.41				
		2.5	5.7	70/59							15000	1.358	10400	87	3.23				
		2.5	5.7	75/63							14800	1.425	9900	92	3.04				
		2.5	5.7	80/67							14600	1.493	9500	97	2.86				
	8.0	4.2	9.6	65/55							15700	1.315	11200	84	3.50				
		4.2	9.6	70/59							15600	1.369	10900	88	3.34				
		4.2	9.6	75/63							15300	1.436	10400	93	3.12				
		4.2	9.6	80/67							15100	1.503	10000	97	2.94				
30	4.0	1.2	2.7	65/55						17200	1.334	12600	86	3.78					
		1.2	2.7	70/59						25200	19700	0.685	27500	36.8	17100	1.388	12400	90	3.61
		1.2	2.7	75/63						26900	19300	0.700	29300	38.4	16800	1.455	11800	94	3.38
		1.2	2.7	80/67						28500	19000	0.715	30900	39.9	16600	1.523	11400	99	3.19
	6.0	2.4	5.5	65/55						30100	18600	0.730	32600	41.2	17800	1.345	13200	86	3.88
		2.4	5.5	70/59						23700	20900	0.664	26000	35.7	17600	1.399	12800	90	3.68
		2.4	5.5	75/63						25300	19700	0.678	27600	37.3	17400	1.466	12400	95	3.48
		2.4	5.5	80/67						26900	19300	0.693	29300	38.8	17200	1.533	12000	100	3.29
	8.0	4.1	9.3	65/55						28500	18600	0.723	32600	41.6	18300	1.356	13700	87	3.95
		4.1	9.3	70/59						23800	20900	0.657	26000	36.2	18200	1.409	13400	91	3.78
		4.1	9.3	75/63						25400	19700	0.671	27700	37.9	17900	1.477	12900	96	3.55
		4.1	9.3	80/67						27000	19400	0.686	29300	39.4	17700	1.544	12400	100	3.36
40	4.0	1.1	2.6	65/55						20100	1.375	15400	89	4.28					
		1.1	2.6	70/59						24300	21300	0.816	27100	29.8	19900	1.429	15000	93	4.08
		1.1	2.6	75/63						25800	20200	0.830	28600	31.1	19700	1.496	14600	98	3.86
		1.1	2.6	80/67						27500	19800	0.845	30400	32.5	19500	1.563	14200	102	3.65
	6.0	2.3	5.4	65/55						30700	19100	0.875	33700	35.1	20600	1.386	15900	90	4.35
		2.3	5.4	70/59						24300	21400	0.809	27100	30.0	20500	1.439	15600	94	4.17
		2.3	5.4	75/63						25900	20200	0.823	28700	31.5	20200	1.507	15100	98	3.92
		2.3	5.4	80/67						27500	19800	0.838	30400	32.8	20000	1.574	14600	103	3.72
	8.0	4.0	9.0	65/55						30700	19100	0.868	33700	35.4	21200	1.396	16400	90	4.45
		4.0	9.0	70/59						24400	21400	0.801	27100	30.5	21000	1.450	16100	94	4.24
		4.0	9.0	75/63						26000	20200	0.816	28800	31.9	20800	1.517	15600	99	4.01
		4.0	9.0	80/67						27600	19900	0.831	30400	33.2	20600	1.585	15200	104	3.81
50	4.0	1.1	2.5	65/55						23100	1.416	18300	93	4.78					
		1.1	2.5	70/59						24500	21700	0.961	27800	25.5	22900	1.469	17900	96	4.56
		1.1	2.5	75/63						26100	20600	0.975	29400	26.8	22700	1.537	17500	101	4.32
		1.1	2.5	80/67						27700	20200	0.990	31100	28.0	22500	1.604	17000	106	4.11
	6.0	2.3	5.2	65/55						30900	19500	1.020	34400	30.3	23600	1.426	18700	93	4.85
		2.3	5.2	70/59						24500	21800	0.953	27800	25.7	23500	1.480	18400	97	4.65
		2.3	5.2	75/63						26100	20600	0.968	29400	27.0	23200	1.547	17900	102	4.39
		2.3	5.2	80/67						27700	20200	0.983	31100	28.2	23000	1.615	17500	106	4.17
	8.0	3.9	8.8	65/55						30900	19500	1.012	34400	30.5	24200	1.437	19300	94	4.93
		3.9	8.8	70/59						24600	21800	0.946	27800	26.0	24000	1.491	18900	98	4.71
		3.9	8.8	75/63						26200	20600	0.960	29500	27.3	23800	1.558	18500	102	4.47
		3.9	8.8	80/67						27800	20300	0.975	31100	28.5	23600	1.625	18100	107	4.25
60	4.0	1.1	2.4	65/55						26100	1.456	21100	96	5.25					
		1.1	2.4	70/59						31000	19500	1.164	34600	26.3	26000	1.510	20800	100	5.04
		1.1	2.4	75/63						24200	21800	1.105	28000	21.9	25700	1.577	20300	105	4.77
		1.1	2.4	80/67						25800	20600	1.119	29600	23.1	25500	1.645	19900	109	4.54
	6.0	2.2	5.1	65/55						30600	19500	1.149	32900	25.2	26700	1.467	21700	97	5.33
		2.2	5.1	70/59						24300	21800	1.098	28000	22.1	26500	1.521	21300	101	5.10
		2.2	5.1	75/63						25900	20300	1.127	31300	24.4	26300	1.588	20900	105	4.85
		2.2	5.1	80/67						27500	20000	1.142	33000	25.5	26100	1.655	20500	110	4.62
	8.0	3.8	8.6	65/55						30700	19500	1.157	34600	26.5	27200	1.478	22200	97	5.39
		3.8	8.6	70/59						24300	21800	1.091	28000	22.3	27100	1.531	21900	101	5.18
		3.8	8.6	75/63						25900	20700	1.105	29700	23.4	26800	1.599	21300	106	4.91
		3.8	8.6	80/67						27500	20300	1.120	31300	24.6	26600	1.666	20900	111	4.68
8.0	3.8	8.6	85/71	30700	19600	1.150	34600	26.7	26600	1.666	20900	111	4.68						

Size 024 (800 CFM) (continued)

EWT (°F)	GPM	WPD		EAT (°F)	Cooling					Heating				
		PSI	FT of W.C.		Total (Btu/hr)	Sensible (Btu/hr)	Power Input (kW)	THR (Btu/hr)	EER	Total (Btu/hr)	Power Input (kW)	THA (Btu/hr)	LAT (°F)	COP
70	4.0	1.0	2.4	65/55	23400	21400	1.250	27700	18.7	29100	1.497	24000	99	5.69
		1.0	2.4	70/59	25000	20300	1.264	29300	19.8	29000	1.551	23700	103	5.47
		1.0	2.4	75/63	26600	19900	1.279	31000	20.8	28700	1.618	23200	108	5.19
		1.0	2.4	80/67	28200	19500	1.294	32600	21.8	28500	1.685	22700	113	4.95
	6.0	2.2	5.0	65/55	23500	21500	1.243	27700	18.9	29700	1.508	24600	100	5.77
		2.2	5.0	70/59	25100	20300	1.257	29400	20.0	29500	1.561	24200	104	5.53
		2.2	5.0	75/63	26700	19900	1.272	31000	21.0	29300	1.629	23700	109	5.27
		2.2	5.0	80/67	28300	19600	1.287	32700	22.0	29100	1.696	23300	113	5.02
		2.2	5.0	85/71	29900	19200	1.302	34300	23.0					
		8.0	3.7	8.4	65/55	23600	21500	1.236	27800	19.1	30200	1.518	25000	101
	3.7		8.4	70/59	25200	20300	1.250	29500	20.2	30100	1.572	24700	105	5.61
	3.7		8.4	75/63	26800	20000	1.265	31100	21.2	29800	1.639	24200	109	5.32
3.7	8.4		80/67	28400	19600	1.280	32800	22.2	29600	1.707	23800	114	5.08	
80	4.0	1.0	2.3	65/55	22300	20900	1.395	27100	16.0	32000	1.538	26800	103	6.09
		1.0	2.3	70/59	23900	19700	1.409	28700	17.0	31800	1.591	26400	107	5.85
		1.0	2.3	75/63	25500	19300	1.424	30400	17.9	31600	1.659	25900	111	5.58
		1.0	2.3	80/67	27100	19000	1.439	32000	18.8	31400	1.726	25500	116	5.33
	6.0	2.1	4.9	65/55	22400	20900	1.387	27100	16.1	32500	1.548	27200	103	6.15
		2.1	4.9	70/59	23900	19700	1.402	28700	17.0	32400	1.602	26900	107	5.92
		2.1	4.9	75/63	25600	19400	1.417	30400	18.1	32100	1.669	26400	112	5.63
		2.1	4.9	80/67	27200	19000	1.432	32100	19.0	31900	1.737	26000	117	5.38
		2.1	4.9	85/71	28800	18600	1.447	33700	19.9					
		8.0	3.6	8.2	65/55	22400	20900	1.380	27100	16.2	33100	1.559	27800	104
	3.6		8.2	70/59	24000	19800	1.394	28800	17.2	32900	1.613	27400	108	5.97
	3.6		8.2	75/63	25600	19400	1.409	30400	18.2	32700	1.680	27000	113	5.70
3.6	8.2		80/67	27200	19000	1.424	32100	19.1	32500	1.747	26500	117	5.45	
90	4.0	1.0	2.3	65/55	20900	20200	1.539	26200	13.6	34600	1.578	29200	106	6.42
		1.0	2.3	70/59	22500	19100	1.554	27800	14.5	34400	1.632	28800	110	6.17
		1.0	2.3	75/63	24100	18700	1.569	29500	15.4	34200	1.699	28400	114	5.89
		1.0	2.3	80/67	25700	18300	1.584	31100	16.2	34000	1.767	28000	119	5.63
	6.0	2.1	4.8	65/55	21000	20300	1.532	26200	13.7	35100	1.589	29700	106	6.47
		2.1	4.8	70/59	22500	19100	1.546	27800	14.6	35000	1.643	29400	110	6.24
		2.1	4.8	75/63	24200	18700	1.561	29500	15.5	34700	1.710	28900	115	5.94
		2.1	4.8	80/67	25800	18400	1.576	31200	16.4	34500	1.777	28400	120	5.68
		2.1	4.8	85/71	27400	18000	1.591	32800	17.2					
		8.0	3.6	8.1	65/55	21000	20300	1.525	26200	13.8	35700	1.600	30200	107
	3.6		8.1	70/59	22600	19100	1.539	27900	14.7	35500	1.653	29900	111	6.29
	3.6		8.1	75/63	24200	18800	1.554	29500	15.6	35300	1.721	29400	116	6.01
3.6	8.1		80/67	25800	18400	1.569	31200	16.4	35100	1.788	29000	120	5.75	
100	4.0	1.0	2.3	65/55	19300	19600	1.684	25000	11.5	Tint = Operation Not Recommended Notes: 1. Operation below 40°F EWT is based upon a 15% methanol anti-freeze solution. 2. Performance stated is at the rated power supply; performance may vary as the power supply varies from the rated. 3. See performance correction tables for operating conditions other than those listed. 4. Interpolation is permissible; extrapolation is not. 5. For performance data outside the EAT listed, refer to the Daikin SelectTools selection program. 6. Table does not reflect fan or pump power corrections for AHR/ISO conditions. 7. Data is base on unit at full load operation.				
		1.0	2.3	70/59	20900	18400	1.698	26700	12.3					
		1.0	2.3	75/63	22500	18100	1.713	28300	13.1					
		1.0	2.3	80/67	24100	17700	1.728	30000	13.9					
	6.0	2.1	4.7	65/55	19400	19600	1.677	25100	11.6					
		2.1	4.7	70/59	21000	18500	1.691	26800	12.4					
		2.1	4.7	75/63	22600	18100	1.706	28400	13.2					
		2.1	4.7	80/67	24200	17700	1.721	30100	14.1					
		2.1	4.7	85/71	25800	17400	1.736	31700	14.9					
		8.0	3.5	8.0	65/55	19400	19700	1.670	25100					
	3.5		8.0	70/59	21000	18500	1.684	26700	12.5					
	3.5		8.0	75/63	22600	18100	1.699	28400	13.3					
3.5	8.0		80/67	24200	17800	1.714	30000	14.1						
110	4.0	1.0	2.3	65/55	17500	18900	1.829	23700	9.6					
		1.0	2.3	70/59	19100	17700	1.843	25400	10.4					
		1.0	2.3	75/63	20700	17300	1.858	27000	11.1					
		1.0	2.3	80/67	22300	17000	1.873	28700	11.9					
	6.0	2.1	4.7	65/55	17600	18900	1.822	23800	9.7					
		2.1	4.7	70/59	19200	17700	1.836	25500	10.5					
		2.1	4.7	75/63	20800	17400	1.851	27100	11.2					
		2.1	4.7	80/67	22400	17000	1.866	28800	12.0					
		2.1	4.7	85/71	24000	16600	1.881	30400	12.8					
		8.0	3.5	7.9	65/55	17600	18900	1.814	23800	9.7				
	3.5		7.9	70/59	19200	17700	1.829	25400	10.5					
	3.5		7.9	75/63	20800	17400	1.844	27100	11.3					
3.5	7.9		80/67	22400	17000	1.859	28700	12.0						
			85/71	24000	16700	1.873	30400	12.8						

Size 030 (1000 CFM)

EWT (°F)	GPM	WPD		EAT (°F)	Cooling					Heating											
		PSI	FT of W.C.		Total (Btu/hr)	Sensible (Btu/hr)	Power Input (kW)	THR (Btu/hr)	EER	Total (Btu/hr)	Power Input (kW)	THA (Btu/hr)	LAT (°F)	COP							
20	5.0	1.8	4.1	65/55	Tint = Operation Not Recommended (See "Appendix-A" on page 87 for table legend.)						17900	1.518	12700	82	3.45						
		1.8	4.1	70/59							17700	1.584	12300	86	3.27						
		1.8	4.1	75/63							17600	1.668	11900	91	3.09						
		1.8	4.1	80/67							17400	1.751	11400	96	2.91						
		1.8	4.1	85/71																	
	7.5	3.7	8.5	65/55							18700	1.533	13500	83	3.57						
		3.7	8.5	70/59							18500	1.600	13000	87	3.39						
		3.7	8.5	75/63							18400	1.684	12700	92	3.20						
		3.7	8.5	80/67							18200	1.767	12200	97	3.02						
		3.7	8.5	85/71																	
	10.0	6.3	14.4	65/55							19500	1.549	14200	84	3.69						
		6.3	14.4	70/59							19400	1.616	13900	88	3.52						
		6.3	14.4	75/63							19200	1.699	13400	93	3.31						
		6.3	14.4	80/67							19000	1.783	12900	97	3.12						
		6.3	14.4	85/71																	
	30	5.0	1.7	4.0							65/55	28300	21000	1.097	32000	25.8	20900	1.590	15500	85	3.85
			1.7	4.0							70/59	30100	21600	1.115	33900	27.0	20800	1.657	15100	89	3.68
			1.7	4.0							80/67	32000	22200	1.133	35900	28.2	20600	1.740	14700	94	3.47
1.7			4.0	85/71	33800	22800	1.151	37700	29.4	20400	1.824	14200	99	3.27							
1.7			4.0	85/71	33800	22800	1.151	37700	29.4												
7.5		3.6	8.3	65/55	26600	21400	1.069	30200	24.9	21700	1.606	16200	86	3.96							
		3.6	8.3	70/59	28400	21100	1.086	32100	26.2	21600	1.673	15900	90	3.78							
		3.6	8.3	75/63	30200	21700	1.104	34000	27.4	21400	1.756	15400	95	3.57							
		3.6	8.3	80/67	32100	22300	1.122	35900	28.6	21200	1.839	14900	100	3.38							
		3.6	8.3	85/71	33900	22900	1.140	37800	29.7												
10.0		6.1	13.9	65/55	26700	21400	1.058	30300	25.2	22500	1.622	17000	87	4.06							
		6.1	13.9	70/59	28500	21100	1.075	32200	26.5	22400	1.688	16600	91	3.89							
		6.1	13.9	75/63	30300	21700	1.093	34000	27.7	22200	1.772	16200	95	3.67							
		6.1	13.9	80/67	32200	22300	1.111	36000	29.0	22000	1.855	15700	100	3.47							
		6.1	13.9	85/71	34000	22900	1.129	37900	30.1												
40		5.0	1.7	3.9	65/55	27600	22100	1.186	31600	23.3	24100	1.660	18400	88	4.25						
			1.7	3.9	70/59	29400	21800	1.203	33500	24.4	24000	1.727	18100	92	4.07						
			1.7	3.9	75/63	31300	22400	1.221	35500	25.6	23800	1.811	17600	97	3.85						
	1.7		3.9	80/67	33100	23000	1.239	37300	26.7	23600	1.894	17100	102	3.65							
	1.7		3.9	85/71	34900	23600	1.257	39200	27.8												
	7.5	3.5	8.0	65/55	27700	22200	1.175	31700	23.6	25000	1.676	19300	89	4.37							
		3.5	8.0	70/59	29500	21800	1.192	33600	24.7	24800	1.743	18900	93	4.17							
		3.5	8.0	75/63	31400	22400	1.210	35500	26.0	24600	1.826	18400	98	3.94							
		3.5	8.0	80/67	33200	23000	1.228	37400	27.0	24400	1.910	17900	102	3.74							
		3.5	8.0	85/71	35000	23600	1.246	39300	28.1												
	10.0	5.9	13.5	65/55	27800	22200	1.164	31800	23.9	25800	1.692	20000	90	4.46							
		5.9	13.5	70/59	29600	21900	1.182	33600	25.0	25600	1.759	19600	94	4.26							
		5.9	13.5	75/63	31500	22500	1.200	35600	26.3	25400	1.842	19100	98	4.04							
		5.9	13.5	80/67	33300	23100	1.218	37500	27.3	25200	1.925	18600	103	3.83							
		5.9	13.5	85/71	35100	23700	1.236	39300	28.4												
	50	5.0	1.6	3.8	65/55	27900	22400	1.300	32300	21.5	27500	1.728	21600	91	4.66						
			1.6	3.8	70/59	29700	22100	1.317	34200	22.6	27300	1.795	21200	95	4.45						
			1.6	3.8	75/63	31500	22700	1.335	36100	23.6	27100	1.879	20700	100	4.22						
1.6			3.8	80/67	33300	23300	1.353	37900	24.6	26900	1.962	20200	105	4.01							
1.6			3.8	85/71	35200	23900	1.371	39900	25.7												
7.5		3.4	7.8	65/55	28000	22500	1.289	32400	21.7	28300	1.744	22300	92	4.75							
		3.4	7.8	70/59	29800	22100	1.306	34300	22.8	28100	1.811	21900	96	4.54							
		3.4	7.8	75/63	31600	22800	1.324	36100	23.9	27900	1.894	21400	101	4.31							
		3.4	7.8	80/67	33400	23400	1.342	38000	24.9	27700	1.978	20900	106	4.10							
		3.4	7.8	85/71	35300	24000	1.360	39900	26.0												
10.0		5.8	13.2	65/55	28100	22500	1.278	32500	22.0	29100	1.760	23100	93	4.84							
		5.8	13.2	70/59	29900	22200	1.295	34300	23.1	28900	1.827	22700	97	4.63							
		5.8	13.2	75/63	31700	22800	1.313	36200	24.1	28700	1.910	22200	101	4.40							
		5.8	13.2	80/67	33500	23400	1.331	38000	25.2	28600	1.993	21800	106	4.20							
		5.8	13.2	85/71	35300	24000	1.349	39900	26.2												
60		5.0	1.6	3.7	65/55	27400	22400	1.424	32300	19.2	30800	1.794	24700	94	5.03						
			1.6	3.7	70/59	29200	22000	1.441	34100	20.3	30700	1.861	24300	98	4.83						
			1.6	3.7	75/63	31100	22600	1.459	36100	21.3	30500	1.944	23900	103	4.59						
	1.6		3.7	80/67	32900	23200	1.477	37900	22.3	30300	2.028	23400	108	4.37							
	1.6		3.7	85/71	34700	23900	1.495	39800	23.2												
	7.5	3.3	7.6	65/55	27500	22400	1.413	32300	19.5	31600	1.810	25400	95	5.11							
		3.3	7.6	70/59	29300	22100	1.430	34200	20.5	31500	1.877	25100	99	4.91							
		3.3	7.6	75/63	31200	22700	1.448	36100	21.5	31300	1.960	24600	104	4.68							
		3.3	7.6	80/67	33000	23300	1.466	38000	22.5	31100	2.044	24100	109	4.46							
		3.3	7.6	85/71	34800	23900	1.484	39900	23.5												
	10.0	5.6	12.8	65/55	27600	22400	1.403	32400	19.7	32400	1.826	26200	96	5.20							
		5.6	12.8	70/59	29400	22100	1.420	34200	20.7	32300	1.893	25800	100	5.00							
		5.6	12.8	75/63	31300	22700	1.438	36200	21.8	32100	1.976	25400	105	4.76							
		5.6	12.8	80/67	33100	23300	1.456	38100	22.7	31900	2.059	24900	109	4.54							
		5.6	12.8	85/71	34900	23900	1.474	39900	23.7												

Size 030 (1000 CFM) (continued)

EWT (°F)	GPM	WPD		EAT (°F)	Cooling					Heating					
		PSI	FT of W.C.		Total (Btu/hr)	Sensible (Btu/hr)	Power Input (kW)	THR (Btu/hr)	EER	Total (Btu/hr)	Power Input (kW)	THA (Btu/hr)	LAT (°F)	COP	
70	5.0	1.6	3.6	65/55	26500	22000	1.564	31800	16.9	34100	1.858	27800	97	5.37	
		1.6	3.6	70/59	28300	21700	1.581	33700	17.9	33900	1.925	27300	101	5.16	
		1.6	3.6	75/63	30100	22300	1.599	35600	18.8	33800	2.008	26900	106	4.93	
		1.6	3.6	80/67	31900	22900	1.617	37400	19.7	33600	2.091	26500	111	4.71	
	7.5	3.3	7.5	65/55	26600	22000	1.553	31900	17.1	34900	1.874	28500	98	5.45	
		3.3	7.5	70/59	28400	21700	1.570	33800	18.1	34700	1.940	28100	102	5.24	
		3.3	7.5	75/63	30200	22300	1.588	35600	19.0	34600	2.024	27700	107	5.01	
		3.3	7.5	80/67	32000	22900	1.606	37500	19.9	34400	2.107	27200	112	4.78	
		3.3	7.5	85/71	33900	23500	1.624	39400	20.9						
	10.0	5.5	12.6	65/55	26700	22100	1.542	32000	17.3	35700	1.889	29300	99	5.53	
		5.5	12.6	70/59	28500	21700	1.559	33800	18.3	35600	1.956	28900	103	5.33	
		5.5	12.6	75/63	30300	22300	1.577	35700	19.2	35400	2.039	28400	108	5.08	
		5.5	12.6	80/67	32100	22900	1.595	37500	20.1	35200	2.123	28000	112	4.85	
	80	5.0	1.5	3.5	65/55	25200	21400	1.723	31100	14.6	37200	1.919	30700	100	5.68
			1.5	3.5	70/59	27000	21100	1.740	32900	15.5	37000	1.986	30200	104	5.46
			1.5	3.5	75/63	28800	21700	1.758	34800	16.4	36800	2.069	29700	109	5.21
1.5			3.5	80/67	30700	22300	1.776	36800	17.3	36600	2.153	29300	114	4.98	
7.5		3.2	7.3	65/55	25300	21500	1.712	31100	14.8	38000	1.935	31400	101	5.75	
		3.2	7.3	70/59	27100	21100	1.729	33000	15.7	37800	2.002	31000	105	5.53	
		3.2	7.3	75/63	28900	21700	1.747	34900	16.5	37600	2.085	30500	110	5.28	
		3.2	7.3	80/67	30800	22400	1.765	36800	17.5	37500	2.168	30100	115	5.06	
		3.2	7.3	85/71	32600	23000	1.783	38700	18.3						
10.0		5.4	12.3	65/55	25400	21500	1.701	31200	14.9	38800	1.951	32100	102	5.82	
		5.4	12.3	70/59	27200	21200	1.718	33100	15.8	38600	2.017	31700	106	5.60	
		5.4	12.3	75/63	29000	21800	1.736	34900	16.7	38500	2.101	31300	110	5.37	
		5.4	12.3	80/67	30900	22400	1.754	36900	17.6	38300	2.184	30800	115	5.13	
90		5.0	1.5	3.5	65/55	23700	20800	1.904	30200	12.4	39900	1.978	33100	103	5.91
			1.5	3.5	70/59	25500	20500	1.921	32100	13.3	39800	2.045	32800	107	5.70
			1.5	3.5	75/63	27400	21100	1.939	34000	14.1	39600	2.128	32300	111	5.45
	1.5		3.5	80/67	29200	21700	1.957	35900	14.9	39400	2.212	31900	116	5.22	
	1.5		3.5	85/71	31000	22300	1.975	37700	15.7						
	7.5	3.2	7.2	65/55	23800	20900	1.893	30300	12.6	40700	1.994	33900	103	5.98	
		3.2	7.2	70/59	25600	20500	1.910	32100	13.4	40600	2.061	33600	107	5.77	
		3.2	7.2	75/63	27500	21100	1.928	34100	14.3	40400	2.144	33100	112	5.52	
		3.2	7.2	80/67	29300	21700	1.946	35900	15.1	40200	2.228	32600	117	5.28	
		3.2	7.2	85/71	31100	22300	1.964	37800	15.8						
	10.0	5.3	12.1	65/55	23900	20900	1.882	30300	12.7	41600	2.010	34700	104	6.06	
		5.3	12.1	70/59	25700	20600	1.899	32200	13.5	41400	2.077	34300	108	5.84	
		5.3	12.1	75/63	27600	21200	1.917	34100	14.4	41200	2.160	33800	113	5.59	
		5.3	12.1	80/67	29400	21800	1.935	36000	15.2	41000	2.243	33300	118	5.35	
		5.3	12.1	85/71	31200	22400	1.953	37900	16.0						
	100	5.0	1.5	3.4	65/55	22200	20300	2.112	29400	10.5	Tint = Operation Not Recommended Notes: 1. Operation below 40°F EWT is based upon a 15% methanol anti-freeze solution. 2. Performance stated is at the rated power supply; performance may vary as the power supply varies from the rated. 3. See performance correction tables for operating conditions other than those listed. 4. Interpolation is permissible; extrapolation is not. 5. For performance data outside the EAT listed, refer to the Daikin SelectTools selection program. 6. Table does not reflect fan or pump power corrections for AHR/ISO conditions. 7. Data is base on unit at full load operation.				
1.5			3.4	70/59	24000	19900	2.129	31300	11.3						
1.5			3.4	75/63	25800	20500	2.147	33100	12.0						
1.5			3.4	80/67	27600	21200	2.165	35000	12.7						
1.5			3.4	85/71	29500	21800	2.183	37000	13.5						
7.5		3.1	7.1	65/55	22300	20300	2.102	29500	10.6						
		3.1	7.1	70/59	24100	20000	2.119	31300	11.4						
		3.1	7.1	75/63	25900	20600	2.137	33200	12.1						
		3.1	7.1	80/67	27700	21200	2.155	35100	12.9						
10.0		5.2	12.0	65/55	22400	20400	2.091	29500	10.7						
		5.2	12.0	70/59	24200	20000	2.108	31400	11.5						
		5.2	12.0	75/63	26000	20600	2.126	33300	12.2						
		5.2	12.0	80/67	27800	21200	2.144	35100	13.0						
		5.2	12.0	85/71	29600	21800	2.162	37000	13.7						
110		5.0	1.5	3.4	65/55	20600	19900	2.351	28600	8.8					
			1.5	3.4	70/59	22400	19500	2.369	30500	9.5					
	1.5		3.4	75/63	24300	20100	2.387	32400	10.2						
	1.5		3.4	80/67	26100	20800	2.405	34300	10.9						
	1.5		3.4	85/71	27900	21400	2.423	36200	11.5						
	7.5	3.1	7.0	65/55	20700	19900	2.341	28700	8.8						
		3.1	7.0	70/59	22500	19600	2.358	30500	9.5						
		3.1	7.0	75/63	24400	20200	2.376	32500	10.3						
		3.1	7.0	80/67	26200	20800	2.394	34400	10.9						
	10.0	5.2	11.8	65/55	20800	20000	2.330	28800	8.9						
		5.2	11.8	70/59	22600	19600	2.347	30600	9.6						
		5.2	11.8	75/63	24500	20200	2.365	32600	10.4						
5.2		11.8	80/67	26300	20800	2.383	34400	11.0							
5.2		11.8	85/71	28100	21400	2.401	36300	11.7							

Size 036 (1250 CFM)

EWT (°F)	GPM	WPD		EAT (°F)	Cooling					Heating																																																																																																																					
		PSI	FT of W.C.		Total (Btu/hr)	Sensible (Btu/hr)	Power Input (kW)	THR (Btu/hr)	EER	Total (Btu/hr)	Power Input (kW)	THA (Btu/hr)	LAT (°F)	COP																																																																																																																	
20	6.0	2.1	4.8	65/55	Tint = Operation Not Recommended (See "Appendix-A" on page 87 for table legend.)	21800	1760	15800	82	3.63	21700	1.835	15400	86	3.46																																																																																																																
		2.1	4.8	70/59												21500	1.929	14900	91	3.26																																																																																																											
		2.1	4.8	80/67																	21400	2.023	14500	96	3.10																																																																																																						
		2.1	4.8	85/71																						22900	1.782	16800	83	3.76																																																																																																	
		4.4	10.1	70/59																											22800	1.858	16500	87	3.59																																																																																												
	4.4	10.1	75/63	22700																																1.952	16000	92	3.41																																																																																								
	4.4	10.1	80/67																																					22500	2.046	15500	97	3.22																																																																																			
	4.4	10.1	85/71																																										24100	1.805	17900	84	3.91																																																																														
	7.4	17.0	70/59																																															24000	1.880	17600	88	3.74																																																																									
	7.4	17.0	75/63																																																				23900	1.974	17200	93	3.55																																																																				
	7.4	17.0	80/67																																																									23700	2.068	16600	97	3.36																																																															
	7.4	17.0	85/71																																																														24700	1.850	18400	84	3.91																																																										
	2.0	4.7	65/55																																																																			24600	1.925	18000	88	3.74																																																					
	2.0	4.7	70/59																																																																								24500	2.019	17600	93	3.55																																																
	2.0	4.7	75/63																																																																													24300	2.113	17100	98	3.37																																											
	2.0	4.7	80/67																																																																																		25900	1.872	19500	85	4.05																																						
	4.3	9.8	65/55																																																																																							25800	1.948	19200	89	3.88																																	
	4.3	9.8	70/59																																																																																												25600	2.042	18600	94	3.67																												
	4.3	9.8	75/63																																																																																																	25500	2.136	18200	99	3.50																							
	4.3	9.8	80/67																																																																																																						27100	1.895	20600	86	4.19																		
4.3	9.8	85/71	27000		1.970	20300	90	4.01																																																																																																																							
7.2	16.4	65/55							26800	2.064	19800	95	3.80																																																																																																																		
7.2	16.4	70/59												26700	2.158	19300	100	3.62																																																																																																													
7.2	16.4	75/63																	27700	2.290	22400	1.157	33800	25.8	27000	1.970	20300	90	4.01																																																																																																		
7.2	16.4	80/67																												27600	2.064	19800	95	3.80																																																																																													
7.2	16.4	85/71		26700																															2.158	19300	100	3.62																																																																																									
2.0	4.5	65/55																																					28900	1.936	22300	87	4.37																																																																																				
2.0	4.5	70/59																																										28700	2.012	21800	91	4.18																																																																															
2.0	4.5	75/63																																															28600	2.106	21400	96	3.98																																																																										
2.0	4.5	80/67																																																				28500	2.200	21000	101	3.79																																																																					
2.0	4.5	85/71																																																									30000	1.959	23300	88	4.48																																																																
4.2	9.5	65/55																																																														29900	2.034	23000	92	4.30																																																											
4.2	9.5	70/59																																																																			29800	2.128	22500	97	4.10																																																						
4.2	9.5	75/63																																																																								29600	2.222	22000	102	3.90																																																	
4.2	9.5	80/67																																																																													31200	1.981	24400	89	4.61																																												
4.2	9.5	85/71																																																																																		31100	2.056	24100	93	4.43																																							
7.0	16.0	65/55																																																																																							30900	2.151	23600	98	4.21																																		
7.0	16.0	70/59																																																																																												30800	2.245	23100	103	4.02																													
7.0	16.0	75/63																																																																																																	32000	2.600	26000	1.380	41400	26.6						28500	2.200	21000	101	3.79													
7.0	16.0	80/67																																																																																																							31900	2.694	25500	1.478	39200						23.1	33300	2.094	26200	95	4.66							
7.0	16.0	85/71	31800		2.788	25000	1.572	42000																																																																																																																	24.2	33100	2.188	25600	99	4.43	
1.9	4.4	65/55							31700	2.882	24500	1.666	44800																																																																																																																		25.3
1.9	4.4	70/59												34600	2.041	27600	91	4.96																																																																																																													
1.9	4.4	75/63																	34400	2.117	27200	95	4.76																																																																																																								
1.9	4.4	80/67																						34300	2.211	26800	100	4.54																																																																																																			
1.9	4.4	85/71		34200																									2.305	26300	105	4.34																																																																																															
4.0	9.2	65/55																															35700	2.064	28700	92	5.06																																																																																										
4.0	9.2	70/59																																				35600	2.139	28300	96	4.87																																																																																					
4.0	9.2	75/63																																									35500	2.233	27900	101	4.66																																																																																
4.0	9.2	80/67																																														35300	2.327	27400	106	4.44																																																																											
4.0	9.2	85/71																																																			37800	2.098	30600	94	5.28																																																																						
6.8	15.5	65/55																																																								37700	2.173	30300	98	5.08																																																																	
6.8	15.5	70/59																																																													37500	2.267	29800	103	4.84																																																												
6.8	15.5	75/63																																																																		37400	2.361	29300	108	4.64																																																							
6.8	15.5	80/67																																																																							39000	2.120	31800	95	5.39																																																		
6.8	15.5	85/71																																																																												38800	2.196	31300	99	5.17																																													
3.9	9.0	65/55																																																																																	38700	2.290	30900	104	4.95																																								
3.9	9.0	70/59																																																																																						38600	2.384	30500	108	4.74																																			
3.9	9.0	75/63																																																																																											40100	2.143	32800	96	5.48																														
3.9	9.0	80/67																																																																																																40000	2.218	32400	99	5.28																									
3.9	9.0	85/71	39900		2.312	32000	104	5.05																																																																																																																							
6.6	15.2	65/55							39700	2.406	31500	109	4.83																																																																																																																		
6.6	15.2	70/59												41700	2.920	41700	29200	1.655																																																																																					47300	25.2																							
6.6	15.2	75/63																	41600	2.910	41600	29100	1.671																																																																																		47300	24.9																					
6.6	15.2	80/67																						41500	2.900	41500	29000	1.686																																																																															47300	24.6																			
6.6	15.2	85/71		41400																									2.890	41400	28900	1.701																																																																													47300	24.3																	

Size 036 (1250 CFM) (continued)

EWT (°F)	GPM	WPD		EAT (°F)	Cooling					Heating				
		PSI	FT of W.C.		Total (Btu/hr)	Sensible (Btu/hr)	Power Input (kW)	THR (Btu/hr)	EER	Total (Btu/hr)	Power Input (kW)	THA (Btu/hr)	LAT (°F)	COP
70	6.0	1.8	4.2	65/55	32500	27400	1.763	38500	18.4	41700	2.173	34300	97	5.62
		1.8	4.2	70/59	34700	26900	1.783	40800	19.5	41600	2.248	33900	101	5.42
		1.8	4.2	75/63	36800	27600	1.804	43000	20.4	41400	2.342	33400	105	5.18
		1.8	4.2	80/67	39000	28400	1.825	45200	21.4	41300	2.436	33000	110	4.96
	9.0	3.9	8.8	65/55	32600	27400	1.747	38600	18.7	42900	2.196	35400	98	5.72
		3.9	8.8	70/59	34800	26900	1.767	40800	19.7	42700	2.271	34900	101	5.51
		3.9	8.8	75/63	37000	27700	1.789	43100	20.7	42600	2.365	34500	106	5.27
		3.9	8.8	80/67	39100	28400	1.810	45300	21.6	42500	2.459	34100	111	5.06
		3.9	8.8	85/71	41300	29100	1.831	47500	22.6					
	12.0	6.5	14.8	65/55	32800	27500	1.732	38700	18.9	44000	2.218	36400	98	5.81
		6.5	14.8	70/59	34900	27000	1.752	40900	19.9	43900	2.293	36100	102	5.61
		6.5	14.8	75/63	37100	27700	1.773	43200	20.9	43800	2.387	35700	107	5.37
6.5		14.8	80/67	39300	28500	1.795	45400	21.9	43600	2.481	35100	112	5.15	
80	6.0	1.8	4.1	65/55	31300	26800	1.946	37900	16.1	44900	2.245	37200	99	5.86
		1.8	4.1	70/59	33500	26300	1.967	40200	17.0	44800	2.320	36900	103	5.65
		1.8	4.1	75/63	35600	27000	1.988	42400	17.9	44700	2.414	36500	108	5.42
		1.8	4.1	80/67	37800	27800	2.009	44700	18.8	44500	2.508	35900	113	5.20
	9.0	3.8	8.6	65/55	31400	26900	1.931	38000	16.3	46100	2.267	38400	100	5.95
		3.8	8.6	70/59	33600	26400	1.951	40300	17.2	46000	2.342	38000	104	5.75
		3.8	8.6	75/63	35800	27100	1.973	42500	18.1	45800	2.436	37500	109	5.51
		3.8	8.6	80/67	38000	27800	1.994	44800	19.1	45700	2.530	37100	114	5.29
		3.8	8.6	85/71	40100	28600	2.015	47000	19.9					
	12.0	6.4	14.6	65/55	31600	26900	1.916	38100	16.5	47200	2.289	39400	101	6.04
		6.4	14.6	70/59	33700	26400	1.936	40300	17.4	47100	2.365	39000	105	5.83
		6.4	14.6	75/63	35900	27200	1.957	42600	18.3	47000	2.459	38600	110	5.60
6.4		14.6	80/67	38100	27900	1.978	44900	19.3	46800	2.553	38100	114	5.37	
90	6.0	1.8	4.1	65/55	29500	26000	2.158	36900	13.7	47500	2.312	39600	101	6.02
		1.8	4.1	70/59	31600	25500	2.178	39000	14.5	47400	2.387	39300	105	5.81
		1.8	4.1	75/63	33800	26200	2.199	41300	15.4	47200	2.482	38700	110	5.57
		1.8	4.1	80/67	36000	27000	2.221	43600	16.2	47100	2.576	38300	115	5.35
	9.0	3.7	8.5	65/55	29600	26000	2.143	36900	13.8	48600	2.335	40600	102	6.09
		3.7	8.5	70/59	31800	25500	2.163	39200	14.7	48500	2.410	40300	106	5.89
		3.7	8.5	75/63	33900	26300	2.184	41400	15.5	48400	2.504	39900	111	5.66
		3.7	8.5	80/67	36100	27000	2.205	43600	16.4	48200	2.598	39300	116	5.43
		3.7	8.5	85/71	38300	27700	2.227	45900	17.2					
	12.0	6.3	14.3	65/55	29700	26100	2.127	37000	14.0	49800	2.357	41800	103	6.19
		6.3	14.3	70/59	31900	25600	2.148	39200	14.9	49700	2.432	41400	107	5.98
		6.3	14.3	75/63	34100	26300	2.169	41500	15.7	49500	2.527	40900	111	5.74
6.3		14.3	80/67	36300	27100	2.190	43800	16.6	49400	2.621	40500	116	5.52	
100	6.0	1.8	4.0	65/55	27400	25200	2.398	35600	11.4					
		1.8	4.0	70/59	29600	24700	2.418	37900	12.2					
		1.8	4.0	75/63	31800	25400	2.439	40100	13.0					
		1.8	4.0	80/67	34000	26200	2.461	42400	13.8					
	9.0	3.7	8.4	65/55	27600	25300	2.383	35700	11.6					
		3.7	8.4	70/59	29700	24800	2.403	37900	12.4					
		3.7	8.4	75/63	31900	25500	2.424	40200	13.2					
		3.7	8.4	80/67	34100	26200	2.445	42400	13.9					
		3.7	8.4	85/71	36300	27000	2.467	44700	14.7					
	12.0	6.2	14.1	65/55	27700	25300	2.367	35800	11.7					
		6.2	14.1	70/59	29900	24800	2.388	38100	12.5					
		6.2	14.1	75/63	32100	25600	2.409	40300	13.3					
6.2		14.1	80/67	34200	26300	2.430	42500	14.1						
110	6.0	1.7	4.0	65/55	25900	24700	2.663	35000	9.7					
		1.7	4.0	70/59	28100	24200	2.684	37300	10.5					
		1.7	4.0	75/63	30300	24900	2.705	39500	11.2					
		1.7	4.0	80/67	32500	25600	2.726	41800	11.9					
	9.0	3.6	8.3	65/55	26100	24700	2.648	35100	9.9					
		3.6	8.3	70/59	28200	24200	2.668	37300	10.6					
		3.6	8.3	75/63	30400	25000	2.690	39600	11.3					
		3.6	8.3	80/67	32600	25700	2.711	41900	12.0					
		3.6	8.3	85/71	34800	26400	2.732	44100	12.7					
	12.0	6.1	14.0	65/55	26200	24800	2.633	35200	10.0					
		6.1	14.0	70/59	28400	24300	2.653	37500	10.7					
		6.1	14.0	75/63	30600	25000	2.674	39700	11.4					
6.1		14.0	80/67	32700	25700	2.695	41900	12.1						
		6.1	14.0	85/71	34900	26500	2.717	44200	12.8					

Tint = Operation Not Recommended
Notes:

1. Operation below 40°F EWT is based upon a 15% methanol anti-freeze solution.
2. Performance stated is at the rated power supply; performance may vary as the power supply varies from the rated.
3. See performance correction tables for operating conditions other than those listed.
4. Interpolation is permissible; extrapolation is not.
5. For performance data outside the EAT listed, refer to the Daikin SelectTools selection program.
6. Table does not reflect fan or pump power corrections for AHR/ISO conditions.
7. Data is base on unit at full load operation.

Size 042 (1400 CFM)

EWT (°F)	GPM	WPD		EAT (°F)	Cooling					Heating					
		PSI	FT of W.C.		Total (Btu/hr)	Sensible (Btu/hr)	Power Input (kW)	THR (Btu/hr)	EER	Total (Btu/hr)	Power Input (kW)	THA (Btu/hr)	LAT (°F)	COP	
20	7.0	1.1	2.5	65/55	Tint = Operation Not Recommended (See "Appendix-A" on page 87 for table legend.)	38600	27900	1.521	43800	25.4	25000	2.358	17000	82	3.10
		1.1	2.5	70/59							24800	2.462	16400	86	2.95
		1.1	2.5	75/63							24700	2.591	15900	91	2.79
		1.1	2.5	80/67							24500	2.721	15200	96	2.64
	10.5	2.3	5.4	65/55							26700	2.392	18500	84	3.27
		2.3	5.4	70/59							26600	2.496	18100	87	3.12
		2.3	5.4	75/63							26400	2.625	17400	92	2.94
		2.3	5.4	80/67							26200	2.755	16800	97	2.78
	14.0	4.0	9.2	65/55							28400	2.426	20100	85	3.43
		4.0	9.2	70/59							28300	2.529	19700	89	3.28
		4.0	9.2	75/63							28100	2.659	19000	93	3.09
		4.0	9.2	80/67							27900	2.789	18400	98	2.93
30	7.0	1.1	2.4	65/55	38600	27900	1.521	43800	25.4	29700	2.411	21500	86	3.61	
		1.1	2.4	70/59						29500	2.515	20900	89	3.43	
		1.1	2.4	75/63						29300	2.645	20300	94	3.24	
		1.1	2.4	80/67						29200	2.774	19700	99	3.08	
	10.5	2.3	5.2	65/55						31400	2.445	23100	87	3.76	
		2.3	5.2	70/59						31300	2.549	22600	91	3.60	
		2.3	5.2	75/63						31100	2.678	22000	95	3.40	
		2.3	5.2	80/67						30900	2.808	21300	100	3.22	
	14.0	3.9	8.9	65/55						33100	2.479	24600	88	3.91	
		3.9	8.9	70/59						33000	2.583	24200	92	3.74	
		3.9	8.9	75/63						32800	2.712	23500	97	3.54	
		3.9	8.9	80/67						32600	2.842	22900	101	3.36	
40	7.0	1.0	2.4	65/55	38800	30300	1.691	44600	22.9	34500	2.488	26000	89	4.06	
		1.0	2.4	70/59						34400	2.592	25600	93	3.89	
		1.0	2.4	75/63						34200	2.722	24900	97	3.68	
		1.0	2.4	80/67						34000	2.851	24300	102	3.49	
	10.5	2.2	5.0	65/55						36200	2.522	27600	90	4.20	
		2.2	5.0	70/59						36100	2.626	27100	94	4.03	
		2.2	5.0	75/63						35900	2.756	26500	99	3.81	
		2.2	5.0	80/67						35700	2.885	25900	103	3.62	
	14.0	3.8	8.6	65/55						37900	2.556	29200	91	4.34	
		3.8	8.6	70/59						37800	2.660	28700	95	4.16	
		3.8	8.6	75/63						37600	2.789	28100	100	3.95	
		3.8	8.6	80/67						37400	2.919	27400	105	3.75	
50	7.0	1.0	2.3	65/55	39500	30900	1.876	45900	21.1	39400	2.595	30500	92	4.45	
		1.0	2.3	70/59						39300	2.698	30100	96	4.27	
		1.0	2.3	75/63						39100	2.828	29400	101	4.05	
		1.0	2.3	80/67						38900	2.958	28800	106	3.85	
	10.5	2.1	4.9	65/55						41100	2.628	32100	93	4.58	
		2.1	4.9	70/59						41000	2.732	31700	97	4.39	
		2.1	4.9	75/63						40800	2.862	31000	102	4.17	
		2.1	4.9	80/67						40600	2.991	30400	107	3.97	
	14.0	3.7	8.4	65/55						42800	2.662	33700	94	4.71	
		3.7	8.4	70/59						42700	2.766	33300	98	4.52	
		3.7	8.4	75/63						42500	2.896	32600	103	4.30	
		3.7	8.4	80/67						42300	3.025	32000	108	4.09	
60	7.0	1.0	2.3	65/55	39400	31000	2.065	46400	19.1	44300	2.720	35000	95	4.77	
		1.0	2.3	70/59						44100	2.824	34500	99	4.57	
		1.0	2.3	75/63						43900	2.954	33800	104	4.35	
		1.0	2.3	80/67						43700	3.083	33200	109	4.15	
	10.5	2.1	4.8	65/55						46000	2.754	36600	96	4.89	
		2.1	4.8	70/59						45800	2.858	36000	100	4.69	
		2.1	4.8	75/63						45700	2.987	35500	105	4.48	
		2.1	4.8	80/67						45500	3.117	34900	110	4.27	
	14.0	3.6	8.2	65/55						47700	2.788	38200	97	5.01	
		3.6	8.2	70/59						47600	2.892	37700	101	4.82	
		3.6	8.2	75/63						47400	3.021	37100	106	4.59	
		3.6	8.2	80/67						47200	3.151	36400	111	4.39	

Size 042 (1400 CFM) (continued)

EWT (°F)	GPM	WPD		EAT (°F)	Cooling					Heating					
		PSI	FT of W.C.		Total (Btu/hr)	Sensible (Btu/hr)	Power Input (kW)	THR (Btu/hr)	EER	Total (Btu/hr)	Power Input (kW)	THA (Btu/hr)	LAT (°F)	COP	
70	7.0	1.0	2.2	65/55	38800	30900	2.269	46500	17.1	49000	2.851	39300	98	5.03	
		1.0	2.2	70/59	41100	30400	2.295	48900	17.9	48900	2.955	38800	102	4.85	
		1.0	2.2	75/63	43400	31200	2.322	51300	18.7	48700	3.085	38200	107	4.62	
		1.0	2.2	80/67	45700	32100	2.350	53700	19.4	48500	3.214	37500	112	4.42	
	10.5	2.1	4.7	65/55	39000	30900	2.246	46700	17.4	50800	2.885	41000	99	5.16	
		2.1	4.7	70/59	41300	30400	2.272	49100	18.2	50600	2.989	40400	103	4.96	
		2.1	4.7	75/63	43600	31300	2.299	51400	19.0	50400	3.118	39800	108	4.73	
		2.1	4.7	80/67	45900	32200	2.327	53800	19.7	50200	3.248	39100	113	4.53	
	14.0	3.5	8.0	65/55	39200	31000	2.223	46800	17.6	52500	2.919	42500	101	5.27	
		3.5	8.0	70/59	41500	30500	2.249	49200	18.5	52300	3.023	42000	104	5.07	
		3.5	8.0	75/63	43800	31400	2.276	51600	19.2	52100	3.152	41300	109	4.84	
		3.5	8.0	80/67	46100	32300	2.303	54000	20.0	51900	3.282	40700	114	4.63	
	80	7.0	0.9	2.2	65/55	37800	30600	2.503	46300	15.1	53600	2.981	43400	101	5.26
			0.9	2.2	70/59	40100	30100	2.529	48700	15.9	53500	3.085	43000	105	5.08
			0.9	2.2	75/63	42400	30900	2.556	51100	16.6	53300	3.215	42300	110	4.85
			0.9	2.2	80/67	44700	31800	2.583	53500	17.3	53100	3.345	41700	115	4.65
10.5		2.0	4.6	65/55	38000	30600	2.480	46500	15.3	55300	3.015	45000	102	5.37	
		2.0	4.6	70/59	40300	30100	2.506	48900	16.1	55200	3.119	44600	106	5.18	
		2.0	4.6	75/63	42600	31000	2.533	51200	16.8	55000	3.249	43900	111	4.96	
		2.0	4.6	80/67	44900	31900	2.560	53600	17.5	54800	3.378	43300	116	4.75	
14.0		3.4	7.9	65/55	38300	30700	2.457	46700	15.6	57100	3.049	46700	104	5.48	
		3.4	7.9	70/59	40500	30200	2.482	49000	16.3	56900	3.153	46100	107	5.28	
		3.4	7.9	75/63	42800	31100	2.510	51400	17.1	56700	3.283	45500	112	5.06	
		3.4	7.9	80/67	45100	32000	2.537	53800	17.8	56500	3.412	44900	117	4.85	
90		7.0	0.9	2.1	65/55	36400	30000	2.778	45900	13.1	58000	3.122	47300	104	5.44
			0.9	2.1	70/59	38700	29500	2.804	48300	13.8	57800	3.226	46800	108	5.25
			0.9	2.1	75/63	41000	30400	2.831	50700	14.5	57600	3.356	46100	113	5.03
			0.9	2.1	80/67	43300	31300	2.858	53100	15.2	57400	3.485	45500	118	4.82
	10.5	2.0	4.5	65/55	36600	30100	2.755	46000	13.3	59700	3.156	48900	105	5.54	
		2.0	4.5	70/59	38900	29600	2.781	48400	14.0	59500	3.260	48400	109	5.34	
		2.0	4.5	75/63	41200	30500	2.808	50800	14.7	59300	3.390	47700	114	5.12	
		2.0	4.5	80/67	43500	31400	2.835	53200	15.3	59100	3.519	47100	119	4.92	
	14.0	3.4	7.7	65/55	36800	30200	2.732	46100	13.5	61400	3.190	50500	106	5.64	
		3.4	7.7	70/59	39100	29700	2.757	48500	14.2	61200	3.294	50000	110	5.44	
		3.4	7.7	75/63	41400	30600	2.785	50900	14.9	61000	3.423	49300	115	5.22	
		3.4	7.7	80/67	43700	31400	2.812	53300	15.5	60900	3.553	48800	120	5.02	
	100	7.0	0.9	2.1	65/55	34300	29200	3.107	44900	11.0	Tint = Operation Not Recommended Notes: 1. Operation below 40°F EWT is based upon a 15% methanol anti-freeze solution. 2. Performance stated is at the rated power supply; performance may vary as the power supply varies from the rated. 3. See performance correction tables for operating conditions other than those listed. 4. Interpolation is permissible; extrapolation is not. 5. For performance data outside the EAT listed, refer to the Daikin SelectTools selection program. 6. Table does not reflect fan or pump power corrections for AHR/ISO conditions. 7. Data is base on unit at full load operation.				
			0.9	2.1	70/59	36600	28700	3.133	47300	11.7					
			0.9	2.1	75/63	38900	29600	3.160	49700	12.3					
			0.9	2.1	80/67	41200	30500	3.188	52100	12.9					
10.5		2.0	4.5	65/55	34500	29300	3.084	45000	11.2						
		2.0	4.5	70/59	36800	28800	3.110	47400	11.8						
		2.0	4.5	75/63	39100	29700	3.137	49800	12.5						
		2.0	4.5	80/67	41400	30500	3.165	52200	13.1						
14.0		3.3	7.6	65/55	34700	29400	3.061	45100	11.3						
		3.3	7.6	70/59	37000	28900	3.087	47500	12.0						
		3.3	7.6	75/63	39300	29800	3.114	49900	12.6						
		3.3	7.6	80/67	41600	30600	3.141	52300	13.2						
110		7.0	0.9	2.1	65/55	31700	28300	3.504	43700	9.0					
			0.9	2.1	70/59	33900	27800	3.530	45900	9.6					
			0.9	2.1	75/63	36200	28700	3.557	48300	10.2					
			0.9	2.1	80/67	38500	29600	3.584	50700	10.7					
	10.5	1.9	4.4	65/55	31900	28400	3.481	43800	9.2						
		1.9	4.4	70/59	34100	27900	3.507	46100	9.7						
		1.9	4.4	75/63	36400	28800	3.534	48500	10.3						
		1.9	4.4	80/67	38700	29700	3.561	50900	10.9						
	14.0	3.3	7.5	65/55	32100	28500	3.458	43900	9.3						
		3.3	7.5	70/59	34300	28000	3.484	46200	9.8						
		3.3	7.5	75/63	36600	28900	3.511	48600	10.4						
		3.3	7.5	80/67	38900	29700	3.538	51000	11.0						

Size 048 (1600 CFM)

EWT (°F)	GPM	WPD		EAT (°F)	Cooling					Heating											
		PSI	FT of W.C.		Total (Btu/hr)	Sensible (Btu/hr)	Power Input (kW)	THR (Btu/hr)	EER	Total (Btu/hr)	Power Input (kW)	THA (Btu/hr)	LAT (°F)	COP							
20	8.0	2.1	4.9	65/55	Tint = Operation Not Recommended (See "Appendix-A" on page 87 for table legend.)					29800	2.676	20700	83	3.26							
		2.1	4.9	70/59						29500	2.805	19900	87	3.08							
		2.1	4.9	75/63						29200	2.968	19100	92	2.88							
		2.1	4.9	80/67						28800	3.130	18100	97	2.69							
		2.1	4.9	85/71																	
	12.0	3.0	6.9	65/55						31000	2.698	21800	84	3.36							
		3.0	6.9	70/59						30700	2.828	21000	88	3.18							
		3.0	6.9	75/63						30400	2.990	20200	92	2.98							
		3.0	6.9	80/67						30000	3.152	19200	97	2.79							
		3.0	6.9	85/71																	
	16.0	4.0	9.2	65/55						32200	2.721	22900	85	3.47							
		4.0	9.2	70/59						31900	2.851	22200	88	3.28							
		4.0	9.2	75/63						31500	3.013	21200	93	3.06							
		4.0	9.2	80/67						31200	3.175	20400	98	2.88							
		4.0	9.2	85/71																	
	30	8.0	2.1	4.7						65/55	44400	32600	1.715	50300	25.9	35200	2.951	25100	90	3.49	
			2.1	4.7						75/63	47200	33400	1.748	53200	27.0	34900	3.113	24300	95	3.28	
			2.1	4.7						80/67	50100	34200	1.781	56200	28.1	34500	3.276	23300	100	3.08	
			2.1	4.7						85/71	53000	35000	1.814	59200	29.2						
			2.1	4.7						85/71											
12.0		2.9	6.7	65/55	41600	33500	1.668	47300	24.9	36700	2.844	27000	87	3.78							
		2.9	6.7	70/59	44500	32600	1.699	50300	26.2	36400	2.974	26200	91	3.58							
		2.9	6.7	75/63	47400	33400	1.732	53300	27.4	36000	3.136	25300	96	3.36							
		2.9	6.7	80/67	50200	34200	1.765	56200	28.4	35700	3.298	24400	101	3.17							
		2.9	6.7	85/71	53100	35000	1.798	59200	29.5												
16.0		3.9	8.9	65/55	41800	33600	1.652	47400	25.3	37800	2.867	28000	88	3.86							
		3.9	8.9	70/59	44600	32700	1.683	50300	26.5	37500	2.996	27300	92	3.67							
		3.9	8.9	75/63	47500	33500	1.716	53400	27.7	37200	3.159	26400	96	3.45							
		3.9	8.9	80/67	50400	34300	1.750	56400	28.8	36800	3.321	25500	101	3.24							
		3.9	8.9	85/71	53200	35100	1.783	59300	29.8												
40	8.0	2.0	4.6	65/55	44700	35500	1.905	51200	23.5	41400	2.962	31300	90	4.09							
		2.0	4.6	70/59	47500	34600	1.937	54100	24.5	41100	3.092	30500	94	3.89							
		2.0	4.6	75/63	50400	35400	1.970	57100	25.6	40800	3.254	29700	98	3.67							
		2.0	4.6	80/67	53200	36200	2.003	60000	26.6	40400	3.416	28700	103	3.46							
		2.0	4.6	85/71	56100	37000	2.036	63000	27.6												
	12.0	2.8	6.5	65/55	44800	35600	1.890	51300	23.7	42600	2.985	32400	91	4.18							
		2.8	6.5	70/59	47600	34700	1.921	54200	24.8	42300	3.114	31700	94	3.98							
		2.8	6.5	75/63	50500	35500	1.954	57200	25.8	41900	3.277	30700	99	3.74							
		2.8	6.5	80/67	53400	36300	1.987	60200	26.9	41600	3.439	29900	104	3.54							
		2.8	6.5	85/71	56200	37100	2.020	63100	27.8												
	16.0	3.8	8.6	65/55	44900	35600	1.874	51300	24.0	43700	3.007	33400	91	4.26							
		3.8	8.6	70/59	47800	34700	1.905	54300	25.1	43400	3.137	32700	95	4.05							
		3.8	8.6	75/63	50600	35500	1.939	57200	26.1	43100	3.299	31800	100	3.83							
		3.8	8.6	80/67	53500	36300	1.972	60200	27.1	42700	3.462	30900	105	3.61							
		3.8	8.6	85/71	56400	37100	2.005	63200	28.1												
50	8.0	2.0	4.5	65/55	45800	37000	2.132	53100	21.5	47300	3.098	36700	93	4.47							
		2.0	4.5	70/59	48700	36100	2.163	56100	22.5	47000	3.227	36000	97	4.26							
		2.0	4.5	75/63	51500	36900	2.196	59000	23.5	46700	3.390	35100	102	4.03							
		2.0	4.5	80/67	54400	37700	2.229	62000	24.4	46300	3.552	34200	107	3.82							
		2.0	4.5	85/71	57300	38500	2.262	65000	25.3												
	12.0	2.8	6.3	65/55	46000	37000	2.116	53200	21.7	48500	3.120	37900	94	4.55							
		2.8	6.3	70/59	48800	36100	2.147	56100	22.7	48200	3.250	37100	98	4.34							
		2.8	6.3	75/63	51700	36900	2.180	59100	23.7	47800	3.412	36200	103	4.10							
		2.8	6.3	80/67	54500	37700	2.213	62100	24.6	47500	3.575	35300	107	3.89							
		2.8	6.3	85/71	57400	38500	2.247	65100	25.5												
	16.0	3.7	8.4	65/55	46100	37100	2.100	53300	22.0	49600	3.143	38900	95	4.62							
		3.7	8.4	70/59	48900	36200	2.132	56200	22.9	49300	3.273	38100	98	4.41							
		3.7	8.4	75/63	51800	37000	2.165	59200	23.9	49000	3.435	37300	103	4.18							
		3.7	8.4	80/67	54700	37800	2.198	62200	24.9	48600	3.597	36300	108	3.96							
		3.7	8.4	85/71	57500	38600	2.231	65100	25.8												
60	8.0	1.9	4.4	65/55	45700	37400	2.370	53800	19.3	53100	3.228	42100	97	4.82							
		1.9	4.4	70/59	48600	36500	2.402	56800	20.2	52800	3.358	41300	100	4.60							
		1.9	4.4	75/63	51500	37300	2.435	59800	21.1	52400	3.520	40400	105	4.36							
		1.9	4.4	80/67	54300	38100	2.468	62700	22.0	52100	3.683	39500	110	4.14							
		1.9	4.4	85/71	57200	38900	2.501	65700	22.9												
	12.0	2.7	6.1	65/55	45900	37500	2.355	53900	19.5	54200	3.251	43100	97	4.88							
		2.7	6.1	70/59	48700	36600	2.386	56800	20.4	54000	3.381	42500	101	4.68							
		2.7	6.1	75/63	51600	37400	2.419	59900	21.3	53600	3.543	41500	106	4.43							
		2.7	6.1	80/67	54500	38200	2.452	62900	22.2	53300	3.705	40700	111	4.21							
		2.7	6.1	85/71	57300	39000	2.485	65800	23.1												
	16.0	3.6	8.2	65/55	46000	37500	2.339	54000	19.7	55400	3.274	44200	98	4.95							
		3.6	8.2	70/59	48900	36600	2.370	57000	20.6	55100	3.403	43500	102	4.74							
		3.6	8.2	75/63	51700	37400	2.403	59900	21.5	54800	3.566	42600	107	4.50							
		3.6	8.2	80/67	54600	38200	2.437	62900	22.4	54400	3.728	41700	111	4.27							
		3.6	8.2	85/71	57500	39000	2.470	65900	23.3												

Size 048 (1600 CFM) (continued)

EWT (°F)	GPM	WPD		EAT (°F)	Cooling					Heating				
		PSI	FT of W.C.		Total (Btu/hr)	Sensible (Btu/hr)	Power Input (kW)	THR (Btu/hr)	EER	Total (Btu/hr)	Power Input (kW)	THA (Btu/hr)	LAT (°F)	COP
70	8.0	1.9	4.3	65/55	44800	37000	2.630	53800	17.0	58600	3.354	47200	100	5.12
		1.9	4.3	70/59	47700	36100	2.661	56800	17.9	58300	3.484	46400	104	4.90
		1.9	4.3	75/63	50500	36900	2.695	59700	18.7	57900	3.646	45500	108	4.65
		1.9	4.3	80/67	53400	37700	2.728	62700	19.6	57600	3.808	44600	113	4.43
	12.0	2.6	6.0	65/55	45000	37100	2.614	53900	17.2	59700	3.377	48200	100	5.18
		2.6	6.0	70/59	47800	36200	2.646	56800	18.1	59400	3.506	47400	104	4.96
		2.6	6.0	75/63	50700	37000	2.679	59800	18.9	59100	3.669	46600	109	4.72
		2.6	6.0	80/67	53500	37800	2.712	62800	19.7	58700	3.831	45600	114	4.49
		2.6	6.0	85/71	56400	38600	2.745	65800	20.5					
		16.0	3.5	8.0	65/55	45100	37100	2.599	54000	17.4	60900	3.399	49300	101
	3.5		8.0	70/59	47900	36200	2.630	56900	18.2	60600	3.529	48600	105	5.03
	3.5		8.0	75/63	50800	37000	2.663	59900	19.1	60200	3.691	47600	110	4.78
3.5	8.0		80/67	53700	37800	2.696	62900	19.9	59900	3.853	46700	114	4.55	
80	8.0	1.8	4.2	65/55	43300	36200	2.919	53300	14.8	63600	3.474	51700	103	5.36
		1.8	4.2	70/59	46100	35300	2.951	56200	15.6	63300	3.604	51000	106	5.14
		1.8	4.2	75/63	49000	36100	2.984	59200	16.4	62900	3.766	50000	111	4.89
		1.8	4.2	80/67	51900	36900	3.017	62200	17.2	62600	3.929	49200	116	4.67
	12.0	2.6	5.9	65/55	43400	36200	2.904	53300	14.9	64700	3.497	52800	103	5.42
		2.6	5.9	70/59	46300	35300	2.935	56300	15.8	64400	3.627	52000	107	5.20
		2.6	5.9	75/63	49100	36100	2.968	59200	16.5	64100	3.789	51200	112	4.95
		2.6	5.9	80/67	52000	36900	3.001	62200	17.3	63700	3.951	50200	117	4.72
		2.6	5.9	85/71	54900	37700	3.034	65300	18.1					
		16.0	3.4	7.9	65/55	43500	36300	2.888	53400	15.1	65900	3.520	53900	104
	3.4		7.9	70/59	46400	35400	2.919	56400	15.9	65600	3.649	53100	108	5.26
	3.4		7.9	75/63	49300	36200	2.952	59400	16.7	65200	3.812	52200	113	5.01
3.4	7.9		80/67	52100	37000	2.985	62300	17.5	64900	3.974	51300	117	4.78	
90	8.0	1.8	4.1	65/55	41200	35200	3.246	52300	12.7	67900	3.590	55600	105	5.54
		1.8	4.1	70/59	44000	34300	3.278	55200	13.4	67600	3.720	54900	109	5.32
		1.8	4.1	75/63	46900	35100	3.311	58200	14.2	67300	3.882	54100	114	5.08
		1.8	4.1	80/67	49700	35900	3.344	61100	14.9	66900	4.044	53100	119	4.84
	12.0	2.5	5.8	65/55	41300	35200	3.231	52300	12.8	69100	3.613	56800	106	5.60
		2.5	5.8	70/59	44100	34400	3.262	55200	13.5	68800	3.742	56000	110	5.38
		2.5	5.8	75/63	47000	35200	3.295	58200	14.3	68400	3.905	55100	114	5.13
		2.5	5.8	80/67	49900	35900	3.328	61300	15.0	68100	4.067	54200	119	4.90
		2.5	5.8	85/71	52800	36700	3.361	64300	15.7					
		16.0	3.4	7.7	65/55	41400	35300	3.215	52400	12.9	70200	3.635	57800	106
	3.4		7.7	70/59	44300	34400	3.246	55400	13.6	70000	3.765	57200	110	5.44
	3.4		7.7	75/63	47100	35200	3.279	58300	14.4	69600	3.927	56200	115	5.19
3.4	7.7		80/67	50000	36000	3.312	61300	15.1	69300	4.089	55300	120	4.96	
100	8.0	1.8	4.1	65/55	38500	34300	3.620	50900	10.6					
		1.8	4.1	70/59	41400	33400	3.651	53900	11.3					
		1.8	4.1	75/63	44300	34200	3.684	56900	12.0					
		1.8	4.1	80/67	47100	35000	3.717	59800	12.7					
	12.0	2.5	5.7	65/55	38700	34400	3.604	51000	10.7					
		2.5	5.7	70/59	41500	33500	3.635	53900	11.4					
		2.5	5.7	75/63	44400	34300	3.669	56900	12.1					
		2.5	5.7	80/67	47300	35100	3.702	59900	12.8					
		2.5	5.7	85/71	50100	35900	3.735	62800	13.4					
		16.0	3.3	7.6	65/55	38800	34400	3.588	51000	10.8				
	3.3		7.6	70/59	41700	33500	3.620	54100	11.5					
	3.3		7.6	75/63	44500	34300	3.653	57000	12.2					
3.3	7.6		80/67	47400	35100	3.686	60000	12.9						
110	8.0	1.8	4.0	65/55	35600	33200	4.048	49400	8.8					
		1.8	4.0	70/59	38400	32300	4.079	52300	9.4					
		1.8	4.0	75/63	41300	33100	4.112	55300	10.0					
		1.8	4.0	80/67	44100	33900	4.146	58300	10.6					
	12.0	2.5	5.7	65/55	35700	33200	4.032	49500	8.9					
		2.5	5.7	70/59	38500	32300	4.064	52400	9.5					
		2.5	5.7	75/63	41400	33100	4.097	55400	10.1					
		2.5	5.7	80/67	44300	33900	4.130	58400	10.7					
		2.5	5.7	85/71	47100	34700	4.163	61300	11.3					
		16.0	3.3	7.5	65/55	35800	33300	4.017	49500	8.9				
	3.3		7.5	70/59	38700	32400	4.048	52500	9.6					
	3.3		7.5	75/63	41500	33200	4.081	55400	10.2					
3.3	7.5		80/67	44400	34000	4.114	58400	10.8						
3.3	7.5	85/71	47300	34800	4.147	61500	11.4							

Tint = Operation Not Recommended
Notes:

1. Operation below 40°F EWT is based upon a 15% methanol anti-freeze solution.
2. Performance stated is at the rated power supply; performance may vary as the power supply varies from the rated.
3. See performance correction tables for operating conditions other than those listed.
4. Interpolation is permissible; extrapolation is not.
5. For performance data outside the EAT listed, refer to the Daikin SelectTools selection program.
6. Table does not reflect fan or pump power corrections for AHR/ISO conditions.
7. Data is base on unit at full load operation.

Size 060 (2000 CFM)

EWT (°F)	GPM	WPD		EAT (°F)	Cooling					Heating					
		PSI	FT of W.C.		Total (Btu/hr)	Sensible (Btu/hr)	Power Input (kW)	THR (Btu/hr)	EER	Total (Btu/hr)	Power Input (kW)	THA (Btu/hr)	LAT (°F)	COP	
20	10.0	2.2	5.1	65/55	Tint = Operation Not Recommended (See "Appendix-A" on page 87 for table legend.)						35600	3.547	23500	82	2.94
		2.2	5.1	70/59							35400	3.690	22800	86	2.81
		2.2	5.1	75/63							35200	3.868	22000	91	2.66
		2.2	5.1	80/67							35000	4.047	21200	96	2.53
	15.0	4.9	11.1	65/55							39000	3.616	26700	84	3.16
		4.9	11.1	70/59							38800	3.759	26000	88	3.02
		4.9	11.1	75/63							38600	3.938	25200	93	2.87
		4.9	11.1	80/67							38400	4.117	24300	98	2.73
	20.0	8.4	19.2	65/55							42400	3.686	29800	86	3.37
		8.4	19.2	70/59							42200	3.829	29100	89	3.23
		8.4	19.2	75/63							42000	4.007	28300	94	3.07
		8.4	19.2	80/67							41800	4.186	27500	99	2.92
30	10.0	2.2	4.9	65/55	41500	33900	2.003	48300	20.7	42900	3.779	30000	90	3.32	
		2.2	4.9	75/63	45400	35200	2.043	52400	22.2	42700	3.958	29200	95	3.16	
		2.2	4.9	80/67	49300	36400	2.083	56400	23.7	42500	4.137	28400	100	3.01	
		2.2	4.9	85/71	53200	37700	2.122	60400	25.1						
	15.0	4.7	10.7	65/55	38000	34800	1.918	44500	19.8	46500	3.706	33900	87	3.67	
		4.7	10.7	70/59	41900	34100	1.956	48600	21.4	46300	3.849	33200	91	3.52	
		4.7	10.7	75/63	45800	35300	1.995	52600	23.0	46100	4.028	32400	96	3.35	
		4.7	10.7	80/67	49700	36600	2.035	56600	24.4	45900	4.206	31500	101	3.20	
	20.0	8.1	18.6	65/55	38400	34900	1.870	44800	20.5	49900	3.775	37000	89	3.87	
		8.1	18.6	70/59	42300	34200	1.908	48800	22.2	49700	3.918	36300	93	3.71	
		8.1	18.6	75/63	46200	35500	1.947	52800	23.7	49500	4.097	35500	98	3.54	
		8.1	18.6	80/67	50100	36700	1.987	56900	25.2	49200	4.276	34600	103	3.37	
40	10.0	2.1	4.8	65/55	46600	40600	2.273	54400	20.5	50500	3.774	37600	89	3.92	
		2.1	4.8	70/59	50500	39900	2.311	58400	21.9	50300	3.917	36900	93	3.76	
		2.1	4.8	75/63	54400	41200	2.351	62400	23.1	50100	4.096	36100	98	3.58	
		2.1	4.8	80/67	58300	42400	2.390	66500	24.4	49900	4.275	35300	103	3.42	
	15.0	4.6	10.4	65/55	47000	40800	2.226	54600	21.1	53900	3.844	40800	91	4.11	
		4.6	10.4	70/59	50900	40100	2.263	58600	22.5	53700	3.987	40100	95	3.94	
		4.6	10.4	75/63	54800	41400	2.303	62700	23.8	53500	4.165	39300	100	3.76	
		4.6	10.4	80/67	58700	42600	2.342	66700	25.1	53300	4.344	38500	105	3.59	
	20.0	7.9	18.0	65/55	47400	41000	2.178	54800	21.8	57300	3.913	43900	92	4.29	
		7.9	18.0	70/59	51300	40300	2.215	58900	23.2	57100	4.056	43300	96	4.12	
		7.9	18.0	75/63	55200	41500	2.255	62900	24.5	56900	4.235	42400	101	3.93	
		7.9	18.0	80/67	59100	42800	2.295	66900	25.8	56700	4.414	41600	106	3.76	
50	10.0	2.0	4.7	65/55	55000	45100	2.682	64200	20.5	58000	3.946	44500	93	4.30	
		2.0	4.7	70/59	58900	44400	2.719	68200	21.7	57800	4.089	43800	97	4.14	
		2.0	4.7	75/63	62800	45700	2.759	72200	22.8	57600	4.268	43000	102	3.95	
		2.0	4.7	80/67	66700	46900	2.799	76300	23.8	57300	4.447	42100	106	3.77	
	15.0	4.4	10.1	65/55	55400	45300	2.634	64400	21.0	61400	4.016	47700	94	4.48	
		4.4	10.1	70/59	59300	44600	2.672	68400	22.2	61200	4.159	47000	98	4.31	
		4.4	10.1	75/63	63200	45800	2.711	72500	23.3	61000	4.337	46200	103	4.12	
		4.4	10.1	80/67	67100	47100	2.751	76500	24.4	60700	4.516	45300	108	3.94	
	20.0	7.7	17.5	65/55	55800	45400	2.586	64600	21.6	64800	4.085	50900	96	4.64	
		7.7	17.5	70/59	59700	44700	2.624	68700	22.8	64600	4.228	50200	100	4.47	
		7.7	17.5	75/63	63600	46000	2.663	72700	23.9	64400	4.407	49400	105	4.28	
		7.7	17.5	80/67	67500	47300	2.703	76700	25.0	64100	4.586	48400	110	4.09	
60	10.0	2.0	4.6	65/55	58500	46900	3.055	68900	19.1	65400	4.139	51300	96	4.63	
		2.0	4.6	70/59	62300	46200	3.092	72900	20.1	65200	4.282	50600	100	4.46	
		2.0	4.6	75/63	66200	47400	3.132	76900	21.1	65000	4.461	49800	105	4.27	
		2.0	4.6	80/67	70100	48700	3.171	80900	22.1	64800	4.639	49000	110	4.09	
	15.0	4.3	9.9	65/55	58900	47000	3.007	69200	19.6	68800	4.208	54400	98	4.79	
		4.3	9.9	70/59	62700	46300	3.044	73100	20.6	68600	4.351	53800	102	4.62	
		4.3	9.9	75/63	66600	47600	3.084	77100	21.6	68400	4.530	52900	106	4.42	
		4.3	9.9	80/67	70600	48900	3.124	81300	22.6	68200	4.709	52100	111	4.24	
	20.0	7.5	17.1	65/55	59300	47200	2.959	69400	20.0	72200	4.278	57600	99	4.94	
		7.5	17.1	70/59	63200	46500	2.997	73400	21.1	72000	4.421	56900	103	4.77	
		7.5	17.1	75/63	67100	47800	3.036	77500	22.1	71800	4.600	56100	108	4.57	
		7.5	17.1	80/67	71000	49000	3.076	81500	23.1	71600	4.778	55300	113	4.39	
				74900	50300	3.116	85500	24.0							

Size 060 (2000 CFM) (continued)

EWT (°F)	GPM	WPD		EAT (°F)	Cooling					Heating				
		PSI	FT of W.C.		Total (Btu/hr)	Sensible (Btu/hr)	Power Input (kW)	THR (Btu/hr)	EER	Total (Btu/hr)	Power Input (kW)	THA (Btu/hr)	LAT (°F)	COP
70	10.0	2.0	4.5	65/55	57100	46400	3.377	68600	16.9	72800	4.338	58000	100	4.91
		2.0	4.5	70/59	60900	45700	3.415	72600	17.8	72700	4.481	57400	103	4.75
		2.0	4.5	75/63	64800	47000	3.454	76600	18.8	72500	4.660	56600	108	4.56
		2.0	4.5	80/67	68700	48200	3.494	80600	19.7	72200	4.839	55700	113	4.37
	15.0	4.2	9.7	65/55	57500	46600	3.329	68900	17.3	76200	4.408	61200	101	5.06
		4.2	9.7	70/59	61300	45900	3.367	72800	18.2	76100	4.551	60600	105	4.90
		4.2	9.7	75/63	65300	47100	3.407	76900	19.2	75900	4.730	59800	110	4.70
		4.2	9.7	80/67	69200	48400	3.446	81000	20.1	75600	4.908	58800	115	4.51
	20.0	7.3	16.8	65/55	57900	46700	3.282	69100	17.6	79600	4.477	64300	103	5.21
		7.3	16.8	70/59	61800	46000	3.319	73100	18.6	79500	4.620	63700	107	5.04
		7.3	16.8	75/63	65700	47300	3.359	77200	19.6	79300	4.799	62900	112	4.84
		7.3	16.8	80/67	69600	48500	3.399	81200	20.5	79000	4.978	62000	116	4.65
80	10.0	1.9	4.4	65/55	53300	44900	3.703	65900	14.4	80300	4.531	64800	103	5.19
		1.9	4.4	70/59	57200	44200	3.741	70000	15.3	80100	4.674	64100	107	5.02
		1.9	4.4	75/63	61100	45500	3.780	74000	16.2	79900	4.853	63300	112	4.82
		1.9	4.4	80/67	65000	46700	3.820	78000	17.0	79700	5.032	62500	117	4.64
	15.0	4.2	9.5	65/55	53700	45100	3.655	66200	14.7	83700	4.601	68000	105	5.33
		4.2	9.5	70/59	57600	44400	3.693	70200	15.6	83500	4.744	67300	108	5.15
		4.2	9.5	75/63	61500	45600	3.733	74200	16.5	83300	4.922	66500	113	4.96
		4.2	9.5	80/67	65400	46900	3.772	78300	17.3	83100	5.101	65700	118	4.77
	20.0	7.2	16.5	65/55	54100	45200	3.608	66400	15.0	87100	4.670	71200	106	5.46
		7.2	16.5	70/59	58000	44500	3.645	70400	15.9	86900	4.813	70500	110	5.29
		7.2	16.5	75/63	61900	45800	3.685	74500	16.8	86700	4.992	69700	115	5.09
		7.2	16.5	80/67	65800	47100	3.725	78500	17.7	86500	5.171	68900	120	4.90
90	10.0	1.9	4.3	65/55	49900	43700	4.100	63900	12.2	87700	4.703	71600	106	5.46
		1.9	4.3	70/59	53800	43000	4.138	67900	13.0	87600	4.846	71100	110	5.29
		1.9	4.3	75/63	57700	44200	4.177	72000	13.8	87300	5.025	70100	115	5.09
		1.9	4.3	80/67	61600	45500	4.217	76000	14.6	87100	5.204	69300	120	4.90
	15.0	4.1	9.3	65/55	50300	43800	4.052	64100	12.4	91100	4.773	74800	108	5.59
		4.1	9.3	70/59	54200	43100	4.090	68200	13.3	91000	4.916	74200	112	5.42
		4.1	9.3	75/63	58100	44400	4.130	72200	14.1	90700	5.095	73300	117	5.21
		4.1	9.3	80/67	62000	45600	4.169	76200	14.9	90500	5.273	72500	122	5.03
	20.0	7.1	16.2	65/55	50700	44000	4.005	64400	12.7	94500	4.842	78000	110	5.71
		7.1	16.2	70/59	54600	43300	4.042	68400	13.5	94400	4.985	77400	113	5.54
		7.1	16.2	75/63	58500	44500	4.082	72400	14.3	94100	5.164	76500	118	5.34
		7.1	16.2	80/67	62400	45800	4.121	76500	15.1	93900	5.343	75700	123	5.15
100	10.0	1.9	4.3	65/55	47800	43000	4.595	63500	10.4	Tint = Operation Not Recommended Notes: 1. Operation below 40°F EWT is based upon a 15% methanol anti-freeze solution. 2. Performance stated is at the rated power supply; performance may vary as the power supply varies from the rated. 3. See performance correction tables for operating conditions other than those listed. 4. Interpolation is permissible; extrapolation is not. 5. For performance data outside the EAT listed, refer to the Daikin SelectTools selection program. 6. Table does not reflect fan or pump power corrections for AHR/ISO conditions. 7. Data is base on unit at full load operation.				
		1.9	4.3	70/59	51700	42300	4.633	67500	11.2					
		1.9	4.3	75/63	55600	43500	4.673	71500	11.9					
		1.9	4.3	80/67	59500	44800	4.712	75600	12.6					
	15.0	4.0	9.2	65/55	48200	43100	4.548	63700	10.6					
		4.0	9.2	70/59	52100	42400	4.585	67700	11.4					
		4.0	9.2	75/63	56000	43700	4.625	71800	12.1					
		4.0	9.2	80/67	59900	44900	4.665	75800	12.8					
	20.0	7.0	16.0	65/55	48700	43300	4.500	64100	10.8					
		7.0	16.0	70/59	52500	42600	4.537	68000	11.6					
		7.0	16.0	75/63	56400	43800	4.577	72000	12.3					
		7.0	16.0	80/67	60300	45100	4.617	76100	13.1					
110	10.0	1.8	4.2	65/55	44000	41300	5.122	61500	8.6					
		1.8	4.2	70/59	47800	40600	5.160	65400	9.3					
		1.8	4.2	75/63	51700	41900	5.199	69400	9.9					
		1.8	4.2	80/67	55600	43100	5.239	73500	10.6					
	15.0	4.0	9.1	65/55	44400	41500	5.074	61700	8.8					
		4.0	9.1	70/59	48200	40800	5.112	65600	9.4					
		4.0	9.1	75/63	52100	42000	5.152	69700	10.1					
		4.0	9.1	80/67	56000	43300	5.191	73700	10.8					
	20.0	6.9	15.8	65/55	44800	41600	5.026	62000	8.9					
		6.9	15.8	70/59	48700	40900	5.064	66000	9.6					
		6.9	15.8	75/63	52600	42200	5.104	70000	10.3					
		6.9	15.8	80/67	56500	43400	5.143	74100	11.0					

Size 070 (2160 CFM)

EWT (°F)	GPM	WPD		EAT (°F)	Cooling					Heating										
		PSI	FT of W.C.		Total (Btu/hr)	Sensible (Btu/hr)	Power Input (kW)	THR (Btu/hr)	EER	Total (Btu/hr)	Power Input (kW)	THA (Btu/hr)	LAT (°F)	COP						
20	12.0	3.2	7.2	65/55	Tint = Operation Not Recommended (See "Appendix-A" on page 87 for table legend.)					44100	4.367	29200	83	2.96						
		3.2	7.2	70/59						43800	4.557	28200	87	2.81						
		3.2	7.2	75/63						43400	4.796	27000	92	2.65						
		3.2	7.2	80/67						43000	5.035	25800	96	2.50						
	18.0	6.9	15.7	65/55						49300	4.469	34000	85	3.23						
		6.9	15.7	70/59						49000	4.660	33100	89	3.08						
		6.9	15.7	75/63						48600	4.898	31900	94	2.91						
		6.9	15.7	85/71						48200	5.137	30700	98	2.75						
	24.0	11.9	27.1	65/55						54500	4.571	38900	87	3.49						
		11.9	27.1	70/59						54200	4.762	37900	91	3.33						
		11.9	27.1	75/63						53800	5.000	36700	96	3.15						
		11.9	27.1	80/67						53400	5.239	35500	100	2.98						
	30	12.0	3.1	7.0						65/55	63400	47300	2.921	73400	21.7	51500	4.526	36100	86	3.33
			3.1	7.0						70/59	67400	48600	2.964	77500	22.7	51200	4.717	35100	90	3.18
			3.1	7.0						80/67	71400	50000	3.006	81700	23.8	50800	4.956	33900	94	3.00
			3.1	7.0						85/71	75400	51300	3.049	85800	24.7	50500	5.195	32800	99	2.85
18.0		6.7	15.2	65/55	60000	48600	2.810	69600	21.4	56700	4.629	40900	88	3.59						
		6.7	15.2	70/59	64000	47500	2.850	73700	22.5	56400	4.819	40000	92	3.43						
		6.7	15.2	75/63	68000	48900	2.893	77900	23.5	56000	5.058	38700	96	3.24						
		6.7	15.2	80/67	72000	50200	2.936	82000	24.5	55600	5.297	37500	101	3.07						
24.0		11.5	26.3	65/55	60600	48800	2.740	70000	22.1	61900	4.731	45800	90	3.83						
		11.5	26.3	70/59	64600	47800	2.780	74100	23.2	61600	4.922	44800	94	3.66						
		11.5	26.3	75/63	68600	49100	2.823	78200	24.3	61200	5.160	43600	98	3.47						
		11.5	26.3	80/67	72600	50400	2.865	82400	25.3	60800	5.399	42400	103	3.30						
40		12.0	3.0	6.8	65/55	65100	52300	3.186	76000	20.4	59700	4.702	43700	89	3.72					
			3.0	6.8	70/59	69000	51200	3.226	80000	21.4	59400	4.893	42700	93	3.55					
			3.0	6.8	75/63	73000	52500	3.269	84200	22.3	59000	5.132	41500	98	3.37					
			3.0	6.8	80/67	77000	53900	3.312	88300	23.2	58600	5.371	40300	102	3.19					
	18.0	6.5	14.7	65/55	65700	52500	3.116	76300	21.1	64900	4.804	48500	91	3.96						
		6.5	14.7	70/59	69600	51400	3.156	80400	22.1	64500	4.995	47500	95	3.78						
		6.5	14.7	75/63	73600	52800	3.198	84500	23.0	64200	5.234	46300	100	3.59						
		6.5	14.7	80/67	77600	54100	3.241	88700	23.9	63800	5.473	45100	104	3.41						
	24.0	11.2	25.5	65/55	66300	52700	3.045	76700	21.8	70000	4.907	53300	93	4.18						
		11.2	25.5	70/59	70200	51700	3.085	80700	22.8	69700	5.097	52300	97	4.00						
		11.2	25.5	75/63	74200	53000	3.128	84900	23.7	69300	5.336	51100	102	3.80						
		11.2	25.5	80/67	78200	54300	3.171	89000	24.7	69000	5.575	50000	106	3.62						
	50	12.0	2.9	6.6	65/55	67200	53800	3.511	79200	19.1	68500	4.894	51800	92	4.10					
			2.9	6.6	70/59	71200	52800	3.551	83300	20.1	68200	5.085	50800	96	3.93					
			2.9	6.6	75/63	75100	54100	3.594	87400	20.9	67800	5.324	49600	101	3.73					
			2.9	6.6	80/67	79100	55400	3.637	91500	21.7	67400	5.562	48400	106	3.55					
18.0		6.3	14.4	65/55	67800	54100	3.441	79500	19.7	73700	4.996	56600	94	4.32						
		6.3	14.4	70/59	71800	53000	3.481	83700	20.6	73400	5.187	55700	98	4.14						
		6.3	14.4	75/63	75700	54300	3.524	87700	21.5	73000	5.426	54500	103	3.94						
		6.3	14.4	80/67	79700	55700	3.566	91900	22.3	72600	5.664	53300	108	3.75						
24.0		10.9	24.9	65/55	68400	54300	3.370	79900	20.3	78900	5.098	61500	96	4.53						
		10.9	24.9	70/59	72400	53200	3.411	84000	21.2	78600	5.289	60500	100	4.35						
		10.9	24.9	75/63	76300	54600	3.453	88100	22.1	78200	5.528	59300	105	4.14						
		10.9	24.9	80/67	80300	55900	3.496	92200	23.0	77800	5.767	58100	110	3.95						
60		12.0	2.8	6.5	65/55	66700	53900	3.846	79800	17.3	78100	5.102	60700	96	4.48					
			2.8	6.5	70/59	70700	52800	3.886	84000	18.2	77800	5.293	59700	100	4.30					
			2.8	6.5	75/63	74700	54100	3.929	88100	19.0	77400	5.531	58500	105	4.10					
			2.8	6.5	80/67	78700	55500	3.971	92300	19.8	77000	5.770	57300	110	3.91					
	18.0	6.1	14.0	65/55	67300	54100	3.776	80200	17.8	83300	5.204	65500	98	4.69						
		6.1	14.0	70/59	71300	53000	3.816	84300	18.7	83000	5.395	64600	102	4.50						
		6.1	14.0	75/63	75300	54400	3.858	88500	19.5	82600	5.633	63400	107	4.29						
		6.1	14.0	80/67	79300	55700	3.901	92600	20.3	82200	5.872	62200	112	4.10						
	24.0	10.6	24.3	65/55	67900	54400	3.705	80500	18.3	88400	5.306	70300	100	4.88						
		10.6	24.3	70/59	71900	53300	3.745	84700	19.2	88100	5.497	69300	104	4.69						
		10.6	24.3	75/63	75900	54600	3.788	88800	20.0	87800	5.736	68200	109	4.48						
		10.6	24.3	80/67	79900	55900	3.831	93000	20.9	87400	5.974	67000	114	4.28						
	10.6	24.3	85/71	83900	57300	3.873	97100	21.7												

Size 070 (2160 CFM) (continued)

EWT (°F)	GPM	WPD		EAT (°F)	Cooling					Heating				
		PSI	FT of W.C.		Total (Btu/hr)	Sensible (Btu/hr)	Power Input (kW)	THR (Btu/hr)	EER	Total (Btu/hr)	Power Input (kW)	THA (Btu/hr)	LAT (°F)	COP
70	12.0	2.8	6.3	65/55	64600	53000	4.192	78900	15.4	88400	5.325	70200	100	4.86
		2.8	6.3	70/59	68500	52000	4.232	82900	16.2	88000	5.516	69200	104	4.67
		2.8	6.3	75/63	72500	53300	4.275	87100	17.0	87700	5.755	68100	109	4.46
		2.8	6.3	80/67	76500	54600	4.317	91200	17.7	87300	5.994	66800	113	4.26
	18.0	6.0	13.7	65/55	65200	53300	4.121	79300	15.8	93500	5.428	75000	102	5.04
		6.0	13.7	70/59	69100	52200	4.162	83300	16.6	93200	5.619	74000	106	4.86
		6.0	13.7	75/63	73100	53500	4.204	87400	17.4	92800	5.857	72800	111	4.64
		6.0	13.7	80/67	77100	54900	4.247	91600	18.2	92500	6.096	71700	115	4.44
	24.0	10.4	23.7	65/55	65800	53500	4.051	79600	16.2	98700	5.530	79800	104	5.23
		10.4	23.7	70/59	69700	52400	4.091	83700	17.0	98400	5.721	78900	108	5.04
		10.4	23.7	75/63	73700	53800	4.134	87800	17.8	98000	5.959	77700	113	4.82
		10.4	23.7	80/67	77700	55100	4.177	92000	18.6	97600	6.198	76400	117	4.61
80	12.0	2.7	6.2	65/55	61500	51800	4.560	77100	13.5	99300	5.565	80300	104	5.22
		2.7	6.2	70/59	65400	50700	4.600	81100	14.2	99000	5.756	79400	108	5.04
		2.7	6.2	75/63	69400	52100	4.643	85200	14.9	98700	5.995	78200	113	4.82
		2.7	6.2	80/67	73400	53400	4.685	89400	15.7	98300	6.233	77000	118	4.62
	18.0	5.9	13.5	65/55	62100	52100	4.489	77400	13.8	104500	5.667	85200	106	5.40
		5.9	13.5	70/59	66000	51000	4.529	81500	14.6	104200	5.858	84200	110	5.21
		5.9	13.5	75/63	70000	52300	4.572	85600	15.3	103800	6.097	83000	115	4.99
		5.9	13.5	80/67	74000	53600	4.615	89800	16.0	103400	6.335	81800	120	4.78
	24.0	10.2	23.3	65/55	62700	52300	4.419	77800	14.2	109700	5.769	90000	108	5.57
		10.2	23.3	70/59	66600	51200	4.459	81800	14.9	109400	5.960	89100	112	5.37
		10.2	23.3	75/63	70600	52500	4.502	86000	15.7	109000	6.199	87800	117	5.15
		10.2	23.3	80/67	74600	53900	4.544	90100	16.4	108600	6.437	86600	122	4.94
90	12.0	2.7	6.1	65/55	58000	50500	4.967	75000	11.7	111000	5.821	91100	109	5.58
		2.7	6.1	70/59	62000	49500	5.007	79100	12.4	110700	6.011	90200	112	5.39
		2.7	6.1	75/63	66000	50800	5.050	83200	13.1	110400	6.250	89100	117	5.17
		2.7	6.1	80/67	69900	52100	5.093	87300	13.7	110000	6.489	87900	122	4.96
	18.0	5.8	13.2	65/55	58600	50800	4.897	75300	12.0	116200	5.923	96000	111	5.74
		5.8	13.2	70/59	62600	49700	4.937	79400	12.7	115900	6.114	95000	114	5.55
		5.8	13.2	75/63	66600	51000	4.979	83600	13.4	115500	6.352	93800	119	5.32
		5.8	13.2	80/67	70500	52300	5.022	87600	14.0	115200	6.591	92700	124	5.12
	24.0	10.0	22.9	65/55	59200	51000	4.826	75700	12.3	121400	6.025	100800	113	5.90
		10.0	22.9	70/59	63200	49900	4.866	79800	13.0	121100	6.216	99900	116	5.70
		10.0	22.9	75/63	67200	51200	4.909	84000	13.7	120700	6.454	98700	121	5.48
		10.0	22.9	80/67	71100	52600	4.952	88000	14.4	120300	6.693	97500	126	5.26
100	12.0	2.6	6.0	65/55	54400	49300	5.436	73000	10.0	Tint = Operation Not Recommended Notes: 1. Operation below 40°F EWT is based upon a 15% methanol anti-freeze solution. 2. Performance stated is at the rated power supply; performance may vary as the power supply varies from the rated. 3. See performance correction tables for operating conditions other than those listed. 4. Interpolation is permissible; extrapolation is not. 5. For performance data outside the EAT listed, refer to the Daikin SelectTools selection program. 6. Table does not reflect fan or pump power corrections for AHR/ISO conditions. 7. Data is base on unit at full load operation.				
		2.6	6.0	70/59	58400	48200	5.476	77100	10.7					
		2.6	6.0	75/63	62400	49500	5.519	81200	11.3					
		2.6	6.0	80/67	66400	50900	5.562	85400	11.9					
	18.0	5.7	13.1	65/55	55000	49500	5.366	73300	10.2					
		5.7	13.1	70/59	59000	48500	5.406	77500	10.9					
		5.7	13.1	75/63	63000	49800	5.448	81600	11.6					
		5.7	13.1	80/67	67000	51100	5.491	85700	12.2					
	24.0	9.9	22.6	65/55	55600	49800	5.295	73700	10.5					
		9.9	22.6	70/59	59600	48700	5.335	77800	11.2					
		9.9	22.6	75/63	63600	50000	5.378	82000	11.8					
		9.9	22.6	80/67	67600	51300	5.421	86100	12.5					
110	12.0	2.6	6.0	65/55	50600	48000	5.990	71000	8.4					
		2.6	6.0	70/59	54500	47000	6.031	75100	9.0					
		2.6	6.0	75/63	58500	48300	6.073	79200	9.6					
		2.6	6.0	80/67	62500	49600	6.116	83400	10.2					
	18.0	5.7	12.9	65/55	51200	48300	5.920	71400	8.6					
		5.7	12.9	70/59	55100	47200	5.960	75400	9.2					
		5.7	12.9	75/63	59100	48500	6.003	79600	9.8					
		5.7	12.9	80/67	63100	49900	6.046	83700	10.4					
	24.0	9.8	22.4	65/55	51800	48500	5.850	71800	8.9					
		9.8	22.4	70/59	55700	47400	5.890	75800	9.5					
		9.8	22.4	75/63	59700	48800	5.932	79900	10.1					
		9.8	22.4	80/67	63700	50100	5.975	84100	10.7					
		9.8	22.4	85/71	67700	51400	6.018	88200	11.2					

Fan Performance – Constant Torque EC Motor

Table 10: Constant torque motor CFM values

Unit Size	Setting	Function	External Static Pressure (inches of water column)												
			.10	.15	.20	.25	.30	.35	.40	.45	.50	.55	.60	.65	.70
007	Setting 4 (High)	Stage 1	368	352	336	320	304	288	272	256	240	224	206	188	180
	Setting 3 (Standard)		341	324	306	289	271	253	235	217	198	180	162	145	
	Setting 2 (Medium)		312	294	275	256	236	216	195	174	152				
	Setting 1 (Low)		312	294	275	256	236	216	195	174	152				
	Setting 4 (High)	Stage 2	394	378	363	348	333	319	304	290	276	262	244		
	Setting 3 (Standard)		368	352	336	320	304	288	272	256	240				
	Setting 2 (Medium)		341	324	306	289	271	253	235	217	198			165	
	Setting 1 (Low)		312	294	275	256	236	216	195	174	152				
	A	Fan Only, Hydronic Heat and WSE	368	352	336	320	304	288	272	256	240				
	B		341	324	306	289	271	253	235	217	198				
	C		312	294	275	256	236	216	195	174	152				
D	264		244	222	199	176	151	125	98						
009	Setting 4 (High)	Stage 1	408	393	378	364	349	335	321	308	294	281	264	246	
	Setting 3 (Standard)		372	356	340	324	308	292	276	261	245	229			
	Setting 2 (Medium)		337	320	302	284	266	248	230	211					
	Setting 1 (Low)		337	320	302	284	266	248	230	211					
	Setting 4 (High)	Stage 2	437	423	409	395	382	368	355	342	330	317	301	285	
	Setting 3 (Standard)		408	393	378	364	349	335	321	308	294	281	264	246	
	Setting 2 (Medium)		372	356	340	324	308	292	276	261	245	229			
	Setting 1 (Low)		337	320	302	284	266	248	230	211					
	A	Fan Only, Hydronic Heat and WSE	408	393	378	364	349	335	321	308	294				
	B		372	356	340	324	308	292	276	261	245				
	C		337	320	302	284	266	248	230	211					
D	274		254	232	210	187	163	139	113						
012	Setting 4 (High)	Stage 1	459	445	431	417	404	390	377	364	351	339	324	309	294
	Setting 3 (Standard)		428	413	399	385	371	358	345	331	319	306	290		
	Setting 2 (Medium)		394	378	363	348	333	319	304	290					
	Setting 1 (Low)		394	378	363	348	333	319	304	290					
	Setting 4 (High)	Stage 2	486	473	459	445	431	417	402	388	374	359	348	337	326
	Setting 3 (Standard)		459	445	431	417	404	390	377	364	351	339	324	309	294
	Setting 2 (Medium)		428	413	399	385	371	358	345	331	319	306	290		
	Setting 1 (Low)		394	378	363	348	333	319	304	290					
	A	Fan Only, Hydronic Heat and WSE	459	445	431	417	404	390	377	364	351	339	324	309	
	B		428	413	399	385	371	358	345	331	319	306	290	265	
	C		394	378	363	348	333	319	304	290	278	264	250		
D	337		319	302	284	266	248	229	210	192	172	153			

Note: Gray tinted areas, outside recommended operating range.

Fan Performance – Constant CFM Type EC Motor

Table 11: Single stage units with constant CFM type EC motor

Unit Size	MicroTech III Unit Controller								I/O Expansion Module			
	Setting	Maximum ESP (in. wg.) ²	¹ Low CFM Heat	¹ High CFM Heat	¹ Low CFM Cool	¹ High CFM Cool	Dehumidification	Electric Heat	Setting	Fan Only	Hydronic Heat	Water-side Economizer
015	4 (High)	0.7	500	560	500	560	475	560	A	500	500	500
	3 (Standard)		440	500	440	500	400	560	B	440	440	440
	2 (Medium)		375	440	375	440	375	560	C	375	375	375
	1 (Low)		375	375	375	375	375	560	D	280	280	375
019	4 (High)	0.7	600	675	600	675	560	675	A	600	600	600
	3 (Standard)		525	600	525	600	480	675	B	525	525	525
	2 (Medium)		440	525	440	525	440	675	C	440	440	440
	1 (Low)		440	440	440	440	440	675	D	320	320	440
024	4 (High)	0.7	800	900	800	900	750	900	A	800	800	800
	3 (Standard)		700	800	700	800	650	900	B	700	700	700
	2 (Medium)		600	700	600	700	600	900	C	600	600	600
	1 (Low)		600	600	600	600	600	900	D	450	450	600
030	4 (High)	0.7	1000	1125	1000	1125	900	1125	A	1000	1000	1000
	3 (Standard)		875	1000	875	1000	800	1125	B	875	875	875
	2 (Medium)		750	875	750	875	750	1125	C	750	750	750
	1 (Low)		750	750	750	750	750	1125	D	560	560	750
036	4 (High)	0.7	1250	1400	1250	1400	1175	1400	A	1250	1250	1250
	3 (Standard)		1090	1250	1090	1250	1050	1400	B	1090	1090	1090
	2 (Medium)		940	1090	940	1090	940	1400	C	940	940	940
	1 (Low)		940	940	940	940	940	1400	D	700	700	940
042	4 (High)	0.7	1400	1575	1400	1575	1320	1575	A	1400	1400	1400
	3 (Standard)		1225	1400	1225	1400	1140	1575	B	1225	1225	1225
	2 (Medium)		1050	1225	1050	1225	1050	1575	C	1050	1050	1050
	1 (Low)		1050	1050	1050	1050	1050	1575	D	785	785	1050
048	4 (High)	0.7	1600	1800	1600	1800	1500	1800	A	1600	1600	1600
	3 (Standard)		1400	1600	1400	1600	1300	1800	B	1400	1400	1400
	2 (Medium)		1200	1400	1200	1400	1200	1800	C	1200	1200	1200
	1 (Low)		1200	1200	1200	1200	1200	1800	D	900	900	1200
060	4 (High)	0.7	2000	2250	2000	2250	1875	2250	A	2000	2000	2000
	3 (Standard)		1750	2000	1750	2000	1625	2250	B	1750	1750	1750
	2 (Medium)		1500	1750	1500	1750	1500	2250	C	1500	1500	1500
	1 (Low)		1500	1500	1500	1500	1500	2250	D	1120	1120	1500
070	4 (High)	0.7	2160	2400	2160	2400	2040	2400	A	2160	2160	2160
	3 (Standard)		1920	2160	1920	2160	1800	2400	B	1920	1920	1920
	2 (Medium)		1710	1920	1710	1920	1710	2400	C	1710	1710	1710
	1 (Low)		1710	1710	1710	1710	1710	2400	D	1330	1330	1710

Notes: ¹ The unit is capable of high-low fan performance through the use of a 2-stage thermostat wired to specific terminals for High-Low CFM fan performance. Standard operation with a 1-stage thermostat is indicated as High CFM fan performance.

² Applications up to 1.0" ESP (in. wg.) are possible. However, increased fan noise should be anticipated and appropriate noise attenuation should be considered.

Table 12: I/O expansion module jumper configuration

I/O Expansion board configuration		
Setting	JP1	JP2
A	Open	Open
B	Shorted	Open
C	Open	Shorted
D	Shorted	Shorted

Figure 26: JP1 & JP2 location on the I/O expansion module

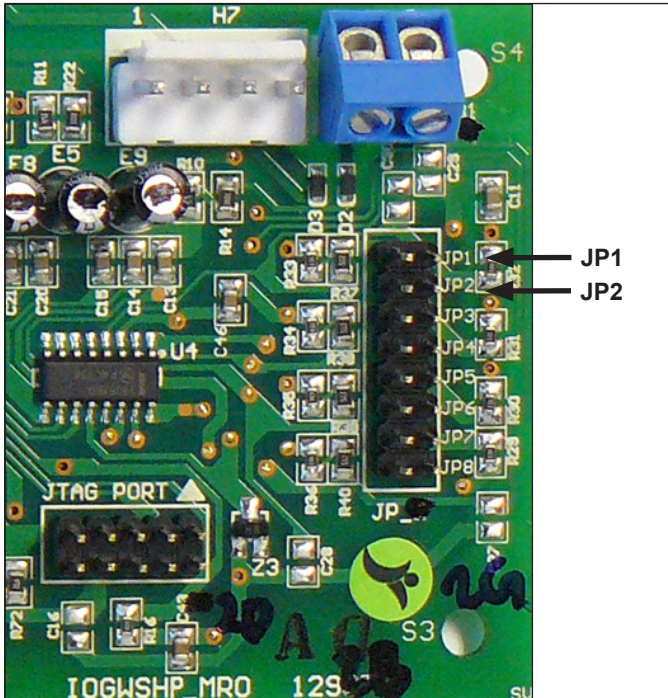

Jumper Settings on I/O Expansion Module

In addition to the 4-position switch, all units have the capability to set CFM values independent to those associated with compressor operation. Independent CFM values can be set for fan only, dehumidification, waterside economizer and hydronic heat from the jumper pins JP1 and JP2 on the I/O expansion module. The jumper pin configurations represent settings A, B, C and D. See Table 12. These settings establish unique CFM settings for the four previously mentioned modes of operation. See Table 11 on page 55 under the I/O Expansion Module. For example, unit size 036 with the 4-position switch set at Setting #3 and the I/O expansion module jumper set at D, will deliver 1250 CFM at stage 2 compressor operation mode, 1090 CFM at stage 1 compressor operation, 1400 CFM in electric heat mode, 700 CFM in fan only mode, 938 CFM in dehumidification mode, 700 CFM in hydronic heat mode and 940 CFM in waterside economizer mode.

Air Flow Correction Factors

Table 13: Air flow correction factors – sizes 007-012

Unit Size	Air Flow		Cooling			Heating	
	CFM/Nominal Ton	% of Nominal	Total Capacity	Sensible Capacity	Power Input	Total Capacity	Power Input
007-012	280	70%	0.946	0.843	0.966	0.966	1.051
	320	80%	0.963	0.890	0.977	0.977	1.033
	400	100%	1.000	1.000	1.000	1.000	1.000
	480	120%	1.040	1.142	1.024	1.024	0.969
	520	130%	1.061	1.228	1.035	1.037	0.954
	560	140%	1.083	1.330	1.048	1.050	0.939
	640	160%	1.131	1.592	1.073	1.076	0.912

Table 14: Air flow correction factors – sizes 015-070

Unit Size	Air Flow Setting	Cooling			Heating	
		Total Capacity	Sensible Capacity	Power Input	Total Capacity	Power Input
015	Setting 4 (High)	1.015	1.074	1.012	1.005	0.973
	Setting 3 (Standard)	1.000	1.000	1.000	1.000	1.000
	Setting 2 (Medium)	0.985	0.935	0.988	0.995	1.028
	Setting 1 (Low)	0.971	0.878	0.977	0.991	1.058
019	Setting 4 (High)	1.013	1.066	1.015	1.008	0.999
	Setting 3 (Standard)	1.000	1.000	1.000	1.000	1.000
	Setting 2 (Medium)	0.987	0.942	0.986	0.992	1.001
	Setting 1 (Low)	0.974	0.890	0.972	0.984	1.003
024	Setting 4 (High)	1.014	1.077	1.021	1.009	0.995
	Setting 3 (Standard)	1.000	1.000	1.000	1.000	1.000
	Setting 2 (Medium)	0.986	0.934	0.980	0.991	1.005
	Setting 1 (Low)	0.972	0.875	0.961	0.982	1.010
030	Setting 4 (High)	1.019	1.098	1.039	1.007	0.996
	Setting 3 (Standard)	1.000	1.000	1.000	1.000	1.000
	Setting 2 (Medium)	0.982	0.918	0.964	0.993	1.004
	Setting 1 (Low)	0.964	0.849	0.931	0.987	1.008
036	Setting 4 (High)	1.016	1.062	1.032	1.010	1.005
	Setting 3 (Standard)	1.000	1.000	1.000	1.000	1.000
	Setting 2 (Medium)	0.985	0.945	0.970	0.991	0.995
	Setting 1 (Low)	0.970	0.896	0.941	0.981	0.991
042	Setting 4 (High)	1.013	1.053	1.034	1.010	1.005
	Setting 3 (Standard)	1.000	1.000	1.000	1.000	1.000
	Setting 2 (Medium)	0.987	0.952	0.968	0.991	0.996
	Setting 1 (Low)	0.975	0.909	0.939	0.981	0.991
048	Setting 4 (High)	1.020	1.080	1.035	1.010	1.004
	Setting 3 (Standard)	1.000	1.000	1.000	1.000	1.000
	Setting 2 (Medium)	0.980	0.931	0.967	0.991	0.996
	Setting 1 (Low)	0.962	0.870	0.937	0.981	0.992
060	Setting 4 (High)	1.012	1.070	1.056	0.990	0.982
	Setting 3 (Standard)	1.000	1.000	1.000	1.000	1.000
	Setting 2 (Medium)	0.988	0.939	0.950	1.010	1.018
	Setting 1 (Low)	0.976	0.885	0.904	1.021	1.037
070	Setting 4 (High)	1.004	1.075	1.076	1.012	1.036
	Setting 3 (Standard)	1.000	1.000	1.000	1.000	1.000
	Setting 2 (Medium)	0.996	0.935	0.934	0.989	0.966
	Setting 1 (Low)	0.992	0.878	0.876	0.978	0.935

Loop Pump Performance

Figure 27: Single pump performance curve

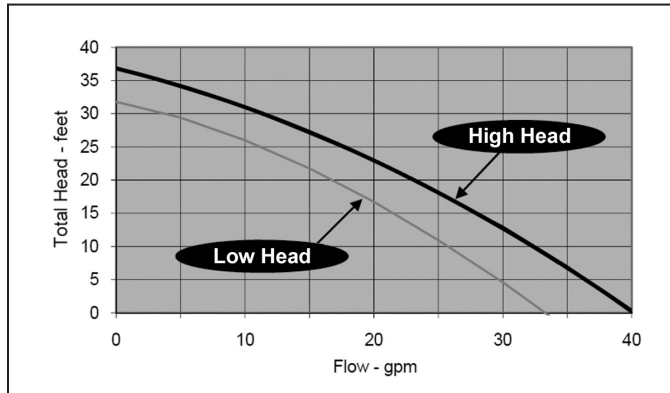
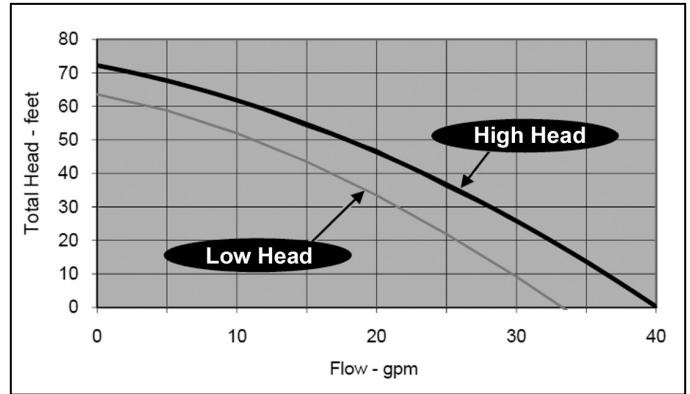

Figure 28: Dual pump performance curve



Desuperheater Performance

Table 15: Desuperheater

Unit Size	Desuperheater GPM	Desuperheater EWT °F	Cooling Mode		Heating Mode	
			Unit EWT °F	Desuperheater Capacity Btu/hr.	Unit EWT °F	Desuperheater Capacity Btu/hr.
024	0.8	90	77	2,300	32	2,200
			90	2,875	70	3,520
030	1.0	90	77	2,875	32	2,750
			90	3,594	70	4,400
036	1.2	90	77	3,450	32	3,300
			90	4,313	70	5,280
042	1.4	90	77	4,025	32	3,850
			90	5,031	70	6,160
048	1.6	90	77	4,600	32	4,400
			90	5,750	70	7,040
060	2.0	90	77	5,750	32	5,500
			90	7,188	70	8,800
070	2.4	90	77	6,900	32	6,600
			90	8,625	70	10,560

Note: Capacity data based on nominal rated CFM and nominal rated GPM.

Electric Heat Performance

Table 16: Electric heat

Nominal Size (Kw)	Applies to Unit Sizes	Voltage													
		208		230		240		265		277		460		480	
		kW	Btuh	kW	Btuh	kW	Btuh	kW	Btuh	kW	Btuh	kW	Btuh	kW	Btuh
5	024 - 070	3.8	12,826	4.6	15,683	5.0	17,076	4.6	15,628	5.0	17,076	4.6	15,683	5.0	17,076
10	024 - 070	7.5	25,652	9.2	31,365	10.0	34,152	8.8	30,007	9.6	32,786	8.8	30,110	9.6	32,786
15	036 - 070	11.3	38,478	13.8	47,048	15.0	51,228	-	-	-	-	13.8	47,048	15.0	51,228
20	036 - 070	14.9	51,047	18.3	62,417	19.9	67,962	-	-	-	-	18.4	62,730	20.0	68,304

Note: Electrical data for SmartSource units with options is available from the Daikin SelectTools™ software selection program. Consult your local Daikin representative for further information.

Waterside Economizer Cooling Capacity - Vertical Unit

Table 17: Model GSV, 250 to 600 CFM¹ – unit sizes 007 through 019

Unit Size	GPM	CFM										³ WPD ft. of wc.
		250		300		400		500		600		
		Total	Sensible	Total	Sensible	Total	Sensible	Total	Sensible	Total	Sensible	
007-012	1	7.5	6.1	8	6.8	8.9	8					0.08
	2	9.1	6.8	10	7.7	11.3	9.4					0.31
	3	10.6	7.4	11.7	8.6	13.4	10.3					0.64
	4	11.3	7.7	12.5	8.8	14.5	10.8					1.19
	² PD (" wc.)	0.05		0.06		0.10						
015-019	2.5					12.8	10.1	14.1	11.8	15.1	13.2	0.5
	4					15.1	11.1	16.7	12.9	18.1	14.6	1.2
	5					16.2	11.5	18.2	13.5	19.6	15.2	1.8
	6					17.1	11.9	19.3	14	21	15.8	2.6
	² PD (" wc.)					0.7		0.1		0.14		

Table 18: Model GSV, 600 to 1400 CFM¹ – unit sizes 024 through 070

Unit Size	GPM	CFM										³ WPD ft. of wc.
		600		800		1000		1200		1400		
		Total	Sensible	Total	Sensible	Total	Sensible	Total	Sensible	Total	Sensible	
024, 030	4	20.2	15.6	22.8	18.9	24.8	21.8	26.4	24.1			0.56
	6	23.4	16.9	26.7	20.6	29.3	23.9	31.3	26.7			1.27
	8	25.5	17.8	29.6	21.8	32.7	25.3	35.1	28.5			2.29
	10	27.1	18.5	31.8	22.7	35.4	26.5	38.2	29.8			3.59
	² PD (" wc.)	0.07		0.108		0.152		0.201				
036	6			36.3	31.0	34.4	28.2	31.9	25.1	28.9	21.6	1.02
	9			43.1	34.1	40.4	30.9	37.3	27.3	33.3	23.4	2.35
	12			36.1	24.6	40.9	28.8	44.8	32.7	48.0	36.2	4.08
	² PD (" wc.)			0.081		0.115		0.152		0.193		
042, 048	8					36.8	27.2	40.0	30.8	42.7	34.1	1.53
	10					39.9	28.5	43.5	32.3	46.6	35.8	2.43
	12					42.2	29.5	46.4	33.5	49.9	37.2	3.46
	² PD (" wc.)					0.086		0.114		0.145		
060, 070	12.5									53.1	38.6	2.67
	15									56.2	39.9	3.79
	18									59.1	41.1	5.38
	² PD (" wc.)									0.141		

Table 19: Model GSV, 1600 to 2400 CFM¹ – unit sizes 042 through 070

Unit Size	GPM	CFM										³ WPD ft. of wc.
		1600		1800		2000		2200		2400		
		Total	Sensible	Total	Sensible	Total	Sensible	Total	Sensible	Total	Sensible	
042, 048	8	44.9	37.1	46.9	39.8							1.53
	10	49.2	39.0	51.6	42.1							2.43
	12	52.8	40.6	55.3	43.7							3.46
	² PD (" wc.)	0.177		0.211								
060, 070	12.5	56.5	42.5	59.5	46.0	62.2	49.3	64.6	52.4	66.8	55.3	2.67
	15	60.1	43.9	63.5	47.8	66.4	51.2	69.1	54.4	71.6	57.5	3.79
	18	63.5	45.3	67.3	49.3	70.7	53.0	73.7	56.5	76.4	59.7	5.38
	² PD (" wc.)	0.172		0.205		0.241		0.278		0.318		

Notes: ¹ Capacity is based on 80/67°F entering air and 45°F entering water temperatures. Total and sensible capacities are MBtuh.

² Air PD is air pressure drop in inches of water column wet coil.

³ WPD is water side pressure drop in feet of water. Coil pressure drop only.

Waterside Economizer Cooling Capacity - Horizontal Unit

Table 20: Model GSH, 250 to 600 CFM¹ – unit sizes 007 through 019

Unit Size	GPM	CFM										³ WPD ft. of wc.
		250		300		400		500		600		
		Total	Sensible	Total	Sensible	Total	Sensible	Total	Sensible	Total	Sensible	
007-012	1	7.1	5.9	7.6	6.7	8.4	7.7					0.1
	2	8.9	6.7	9.7	7.6	10.9	9.2					0.33
	3	10.1	7.2	11.1	8.2	12.6	10					0.73
	4	11	7.6	12.1	8.7	14	10.6					1.32
	² PD (" wc.)	0.06		0.08		0.11						
015-019	2.5					12.8	10.1	14.1	11.8	15.1	13.2	0.5
	4					15.1	11.1	16.7	12.9	18.1	14.6	1.2
	5					16.2	11.5	18.2	13.5	19.6	15.2	1.8
	6					17.1	11.9	19.3	14	21	15.8	2.6
	² PD (" wc.)					0.7		0.1		0.14		

Table 21: Model GSH, 600 to 1400 CFM¹ – unit sizes 024 through 070

Unit Size	GPM	CFM										³ WPD ft. of wc.
		600		800		1000		1200		1400		
		Total	Sensible	Total	Sensible	Total	Sensible	Total	Sensible	Total	Sensible	
024, 030	4	21.6	16.2	24.6	19.6	26.8	22.6	28.6	25.1			0.85
	6	25.1	17.6	29.0	21.5	31.9	25.0	34.3	28.0			1.99
	8	27.3	18.6	32.0	22.8	35.6	26.5	38.5	29.9			3.46
	10	28.9	19.2	34.3	23.7	38.4	27.7	41.8	31.2			5.3
	² PD (" wc.)	0.069		0.108		0.152		0.203				
036	6			30.5	22.2	33.8	25.9	36.6	29.2	38.8	32.1	1.4
	9			34.9	24.1	39.4	28.2	42.9	31.9	45.9	35.3	3.07
	12			37.8	25.3	43.0	29.8	47.4	33.8	50.9	37.5	5.31
	² PD (" wc.)			0.075		0.105		0.138		0.174		
042, 048	8					39.9	28.5	43.7	32.3	46.8	35.8	2.54
	10					43.0	29.8	47.4	33.9	51.0	37.6	3.88
	12					45.4	30.8	50.3	35.1	54.4	39.1	5.48
	² PD (" wc.)					0.082		0.108		0.136		
060, 070	12.5									51.7	37.7	2.69
	15									55.1	39.1	3.82
	18									58.3	40.5	5.42
	² PD (" wc.)									0.115		

Table 22: Model GSH, 1600 to 2400 CFM¹ – unit sizes 042 through 070

Unit Size	GPM	CFM										³ WPD ft. of wc.
		1600		1800		2000		2200		2400		
		Total	Sensible	Total	Sensible	Total	Sensible	Total	Sensible	Total	Sensible	
042, 048	8	49.5	39.0	51.8	42.0							2.54
	10	54.1	41.0	56.8	44.2							3.88
	12	57.9	42.7	60.9	46.0							5.48
	² PD (" wc.)	0.166		0.199								
060, 070	12.5	55.0	41.3	57.8	44.6	60.4	47.7	62.7	50.6	64.8	53.3	2.69
	15	58.9	42.9	62.2	46.4	65.0	49.7	67.6	52.8	69.9	55.7	3.82
	18	62.6	44.5	66.3	48.1	69.6	51.6	72.5	54.9	75.2	57.9	5.42
	² PD (" wc.)	0.142		0.17		0.2		0.229		0.263		

Notes: ¹ Capacity is based on 80/67°F entering air and 45°F entering water temperatures. Total and sensible capacities are MBtuh.

² Air PD is air pressure drop in inches of water column wet coil.

³ WPD is water side pressure drop in feet of water. Coil pressure drop only.

Hydronic Coil Performance

Table 23: Hydronic coil performance

Unit	Flow Rate (gpm)	Entering Water Temperature °F							
		90		100		110		120	
		Capacity (BTU's/hr)		Capacity (BTU's/hr)		Capacity (BTU's/hr)		Capacity (BTU's/hr)	
		WPD (ft w.c.)	LWT (°F)	WPD (ft w.c.)	LWT (°F)	WPD (ft w.c.)	LWT (°F)	WPD (ft w.c.)	LWT (°F)
007 271 CFM 0.018 in wg APD	0.88	3,412		4,992		6,586		8,194	
		0.64	82.2	0.64	88.6	0.64	94.9	0.64	101.2
	1.17	3,652		5,336		7,034		8,742	
		1.09	83.7	1.09	90.8	1.09	97.9	1.09	104.9
	1.75	3,890		5,676		7,462		9,252	
		2.32	85.5	2.32	93.5	2.32	101.4	2.32	109.3
2.33	3,998		5,826		7,654		9,486		
	3.96	86.6	3.96	95.0	3.96	103.4	3.96	111.8	
009 308 CFM 0.018 in wg APD	1.13	5,186		7,602		10,050		12,524	
		1.02	80.8	1.02	90.5	1.02	97.7	1.02	105.0
	1.50	5,706		8,360		11,044		13,726	
		1.74	84.9	1.74	92.7	1.74	100.7	1.74	108.6
	2.25	6,268		9,146		12,036		14,938	
		3.71	86.5	3.71	95.0	3.71	103.6	3.71	112.2
3.00	6,542		9,540		12,548		15,564		
	6.36	87.3	6.36	96.2	6.36	105.1	6.36	114.0	
012 371 CFM 0.022 in wg APD	1.50	6,358		9,322		12,326		15,334	
		1.74	81.5	1.74	87.5	1.74	93.4	1.74	99.3
	2.00	6,930		10,136		13,352		16,582	
		2.98	83.0	2.98	89.8	2.98	96.5	2.98	103.2
	3.00	7,516		10,966		14,432		17,910	
		6.36	85.0	6.36	92.6	6.36	100.3	6.36	107.9
4.00	7,816		11,398		14,994		18,598		
	10.89	86.1	10.89	94.3	10.89	102.4	10.89	110.6	
015 440 CFM 0.05 in wg APD	1.88	8,112		11,868		15,616		19,376	
		3.05	81.3	3.05	87.3	3.05	93.2	3.05	99.1
	2.50	8,720		12,716		16,726		20,748	
		5.19	83.0	5.19	89.8	5.19	96.5	5.19	103.2
	3.75	9,332		13,600		17,878		22,168	
		11.06	85.0	11.06	92.7	11.06	100.4	11.06	108.0
5.00	9,638		14,040		18,452		22,870		
	18.92	86.1	18.92	94.3	18.92	102.5	18.92	110.7	
019 525 CFM 0.054 in wg APD	2.38	9,678		14,120		18,582		23,060	
		4.74	81.8	4.74	88.0	4.74	94.2	4.74	100.4
	3.17	10,330		15,066		19,818		24,586	
		8.09	83.4	8.09	90.4	8.09	97.4	8.09	104.3
	4.75	11,018		16,056		21,110		26,176	
		17.20	85.3	17.20	93.2	17.20	101.0	17.20	108.8
6.33	11,366		16,558		21,762		26,976		
	29.38	86.4	29.38	94.7	29.38	103.1	29.38	111.4	
024 700 CFM 0.061 in wg APD	3.00	13,588		19,824		26,056		32,298	
		5.09	80.9	5.09	86.7	5.09	92.5	5.09	98.2
	4.00	14,634		21,320		28,022		34,734	
		8.75	82.6	8.75	89.3	8.75	95.9	8.75	102.4
	6.00	15,584		22,696		29,820		36,952	
		18.78	84.8	18.78	92.4	18.78	100.0	18.78	107.5
8.00	16,002		23,296		30,600		37,910		
	32.29	86.0	32.29	94.1	32.29	102.3	32.29	110.4	

Hydronic Coil Performance (Continued)

Unit	Flow Rate (gpm)	Entering Water Temperature °F							
		90		100		110		120	
		Capacity (BTU's/hr)		Capacity (BTU's/hr)		Capacity (BTU's/hr)		Capacity (BTU's/hr)	
		WPD (ft w.c.)	LWT (°F)	WPD (ft w.c.)	LWT (°F)	WPD (ft w.c.)	LWT (°F)	WPD (ft w.c.)	LWT (°F)
030 875 CFM 0.084 in wg APD	3.75	16,718		24,364		32,032		39,714	
		0.72	81.0	0.74	86.9	0.74	92.7	7.75	98.6
	5.00	17,972		26,188		34,426		42,680	
		13.33	82.8	13.33	89.4	13.33	96.1	13.33	102.7
	7.50	19,168		27,920		36,688		45,472	
		28.59	84.9	28.59	92.5	28.59	100.1	28.59	107.7
10.00	19,716		28,708		37,714		46,730		
	49.15	86.0	49.15	94.2	49.15	102.4	49.15	110.5	
036 1090 CFM 0.227 in wg APD	4.50	19,686		28,688		37,714		46,758	
		6.81	81.2	6.81	87.2	6.81	93.1	6.81	99.0
	6.00	21,062		30,690		40,340		50,008	
		11.44	82.9	11.44	89.7	11.44	96.4	11.44	103.1
	9.00	22,482		32,746		43,030		53,328	
		23.76	85.0	23.76	92.7	23.76	100.3	23.76	108.0
12.00	23,204		33,790		44,392		55,006		
	39.90	86.1	39.90	94.3	39.90	102.5	39.90	110.7	
042 1225 CFM 0.066 in wg APD	5.25	21,988		32,084		42,224		52,042	
		8.83	81.6	8.83	87.7	8.83	93.8	8.83	99.8
	7.00	23,656		34,506		45,402		56,332	
		14.99	83.2	14.99	90.1	14.99	96.9	14.99	103.7
	10.50	25,362		36,972		48,618		60,296	
		31.60	85.1	31.60	92.9	31.60	100.6	31.60	108.4
14.00	26,208		38,188		50,200		62,236		
	53.66	86.2	53.66	94.5	53.66	102.8	53.66	111.0	
048 1400 CFM 0.080 in wg APD	6.00	24,660		35,986		47,366		58,792	
		11.28	81.7	11.28	87.9	11.28	94.1	11.28	100.2
	8.00	26,512		38,676		50,892		63,152	
		19.16	83.3	19.16	90.3	19.16	97.2	19.16	104.0
	12.00	28,430		41,450		54,512		67,612	
		40.41	85.2	40.41	93.0	40.41	100.8	40.41	108.6
16.00	29,398		42,842		56,322		69,832		
	68.61	86.3	68.61	94.6	68.61	102.9	68.61	111.2	
060 1750 CFM 0.111 in wg APD	7.50	29,730		43,396		57,132		70,926	
		17.01	82.3	17.01	88.3	17.01	94.6	17.01	100.9
	10.00	31,916		46,568		61,290		76,066	
		28.89	83.6	28.89	90.6	28.89	97.6	28.89	104.6
	15.00	34,224		49,906		64,644		81,430	
		60.93	85.4	60.93	93.3	60.93	101.2	60.93	109.0
20.00	35,418		51,622		67,874		84,166		
	103.46	86.4	103.46	94.8	103.46	103.1	103.46	111.5	
070 1920 CFM 0.127 in wg APD	8.75	32,614		47,604		62,672		77,806	
		22.60	82.5	22.60	89.0	22.60	95.5	22.60	102.0
	11.67	34,846		50,842		66,912		83,044	
		38.39	84.0	38.39	91.2	38.39	98.4	38.39	105.6
	17.50	37,194		54,232		71,332		88,484	
		80.92	85.7	80.92	93.8	80.92	101.8	80.92	109.8
23.33	38,416		55,990		73,616		91,284		
	137.36	86.7	137.36	95.2	137.36	103.6	137.36	112.1	

Note: See "Appendix-B" on page 87 for table legend

Table 24: Standard unit without options

Unit Size	Power	Compressor		Fan Motor FLA	Total Unit FLA	Minimum Voltage	Minimum Circuit Amps	Maximum Fuse or HACR Breaker Size
	Voltage/Hz/Phase	RLA	LRA					
007	115/60/1	6.1	29.0	1.8	7.9	104	9.4	15
	208-230/60/1	3.0	15.0	0.9	3.9	197	4.7	15
	265/60/1	2.7	11.0	0.8	3.5	239	4.1	15
009	115/60/1	8.0	50.0	1.8	9.8	104	11.8	15
	208-230/60/1	3.7	22.0	0.9	4.6	197	5.6	15
	265/60/1	3.5	22.0	0.8	4.3	239	5.1	15
012	115/60/1	9.5	50.0	1.8	11.3	104	13.6	20
	208-230/60/1	4.7	25.0	0.9	5.6	197	6.8	15
	265/60/1	4.2	22.0	0.8	5.0	239	6.0	15
015	208-230/60/1	5.6	29.0	2.8	8.4	197	9.8	15
	265/60/1	5.0	28.0	2.4	7.4	239	8.7	15
019	208-230/60/1	6.6	33.0	2.8	9.4	197	11.1	15
	265/60/1	5.6	28.0	2.4	8.0	239	9.4	15
024	208-230/60/1	13.5	58.3	2.8	16.3	197	19.7	30
	265/60/1	9.0	54.0	2.4	11.4	239	13.7	20
	208-230/60/3	7.1	55.4	2.8	9.9	197	11.7	15
	*460/60/3	3.5	28.0	2.4	5.9	414	6.8	15
030	208-230/60/1	12.8	64.0	5.0	17.8	197	21.0	30
	265/60/1	10.9	60.0	4.1	15.0	239	17.7	25
	208-230/60/3	8.3	58.0	5.0	13.3	197	15.4	20
	*460/60/3	5.1	28.0	4.1	9.2	414	10.5	15
036	208-230/60/1	14.1	77.0	5.0	19.1	197	22.6	35
	265/60/1	12.2	72.0	4.1	16.3	239	19.4	30
	208-230/60/3	9.0	71.0	5.0	14.0	197	16.3	25
	*460/60/3	5.6	38.0	4.1	9.7	414	11.1	15
042	208-230/60/1	17.9	112.0	5.9	23.8	197	28.3	45
	208-230/60/3	13.5	88.0	5.9	19.4	197	22.9	35
	*460/60/3	6.0	44.0	5.5	11.5	414	13.0	15
048	208-230/60/1	21.8	117.0	5.9	27.7	197	33.2	50
	208-230/60/3	13.7	83.1	5.9	19.6	197	23.0	35
	*460/60/3	6.2	41.0	5.5	11.7	414	13.3	15
060	208-230/60/1	26.4	134.0	7.4	33.8	197	40.4	60
	208-230/60/3	16.0	110.0	7.4	23.4	197	27.4	40
	*460/60/3	7.8	52.0	6.9	14.7	414	16.7	20
070	208-230/60/1	31.1	178.0	7.4	38.5	197	46.3	60
	208-230/60/3	19.6	136.0	7.4	27.0	197	31.9	50
	*460/60/3	8.2	66.1	6.9	15.1	414	17.2	25

Note: *All 460/60/3 units require 4-wire power which includes a neutral wire. See "Appendix-C" on page 87.

Table 25: Electric heat availability

Model	Nominal Capacity	Unit Voltage	Single Power Point			Dual Power Point					
			Electric Heat		Secondary Heat Control	Electric Heat		Secondary Heat Control	Electric Heat		Secondary Heat Control
			5kW	10kW		5kW	10kW		15kW	20kW	
GSV	024	208-230/60/1	•	•	B,E,P	•	•	S			
		265/60/1	•		B,E,P	•		S			
		208-230/60/3	•	•	B,E,P	•	•	S			
		460/60/3	•	•	B,E,P	•	•	S			
	030	208-230/60/1	•	•	B,E,P	•	•	S			
		265/60/1	•		B,E,P	•		S			
		208-230/60/3	•	•	B,E,P	•	•	S			
		460/60/3	•	•	B,E,P	•	•	S			
	036	208-230/60/1	•	•	B,E,P	•	•	S	•		B,E,P,S
		265/60/1	•		B,E,P	•		S			
		208-230/60/3	•	•	B,E,P	•	•	S	•		B,E,P,S
		460/60/3	•	•	B,E,P	•	•	S	•		B,E,P,S
	042	208-230/60/1	•	•	B,E,P	•	•	S	•	•	B,E,P,S
		208-230/60/3	•		B,E,P	•		S			
		460/60/3	•	•	B,E,P	•	•	S	•	•	B,E,P,S
	048	208-230/60/1	•	•	B,E,P	•	•	S	•	•	B,E,P,S
		208-230/60/3	•		B,E,P	•		S			
		460/60/3	•	•	B,E,P	•	•	S	•	•	B,E,P,S
	060	208-230/60/1	•	•	B,E,P	•	•	S	•	•	B,E,P,S
		208-230/60/3	•		B,E,P	•		S			
		460/60/3	•	•	B,E,P	•	•	S	•	•	B,E,P,S
	070	208-230/60/1	•	•	B,E,P	•	•	S	•	•	B,E,P,S
		208-230/60/3	•		B,E,P	•		S			
		460/60/3	•	•	B,E,P	•	•	S	•	•	B,E,P,S

Legend: B = Boilerless, E = Emergency, P = Primary, S = Supplemental

Motorized 2-Way Water Valve

Table 26: Motorized water valve correction factors

Unit Size	Cv	MOPD	Water Pressure Drop Adders		
			GPM	PSI	Ft of H ₂ O
007	4.9	150	1.0	0.04	0.10
			1.5	0.09	0.22
			2.0	0.17	0.38
009	4.9	150	1.5	0.09	0.22
			2.3	0.21	0.49
			3.0	0.37	0.86
012	4.9	150	2.0	0.17	0.38
			3.0	0.37	0.86
			4.0	0.67	1.54
015	10.3	150	2.5	0.06	0.14
			3.8	0.13	0.31
			5.0	0.24	0.54
019	10.3	150	3.2	0.09	0.22
			4.8	0.21	0.49
			6.3	0.38	0.87
024	10.3	150	4.0	0.15	0.35
			6.0	0.34	0.78
			8.0	0.60	1.39
030	10.3	150	5.0	0.24	0.54
			7.5	0.53	1.22
			10.0	0.94	2.17
036	8.9	150	6.0	0.45	1.05
			9.0	1.02	2.36
			12.0	1.82	4.19
042	8.9	150	7.0	0.62	1.43
			10.5	1.39	3.21
			14.0	2.47	5.71
048	8.9	150	8.0	0.81	1.86
			12.0	1.82	4.19
			16.0	3.23	7.46
060	8.9	150	10.0	1.26	2.91
			15.0	2.84	6.55
			20.0	5.05	11.65
070	8.9	150	11.7	1.72	3.96
			17.5	3.87	8.92
			23.3	6.87	15.86

Formula:

$$\Delta P = SL \left(\frac{QL}{Cv} \right)^2$$

Where:
Cv – Valve (Flow) coefficient for valves

QL – Liquid flow in gallons per minute (GPM)

Qg – Rate of gas flow in cubic feet per minute at standard conditions, 14.7 PSIA and 60°F (SCFM)

P1 – Absolute inlet pressure (PSIA)

P1 = Gauge pressure (PSIG) + 14.7

P – Pressure drop in pounds per square inch (PSI)

SL – Specific gravity of flowing liquid relative water at 60°F

Sg – Specific gravity of gas relative to air.

T – Absolute temperature in degrees Rankine, (°R)

T = °F+460

Antifreeze

Table 27: Antifreeze correction factors

	Antifreeze % by weight			
	15%	25%	35%	45%
Ethanol				
Cooling Capacity	0.985	–	–	–
Heating Capacity	0.9825	–	–	–
Pressure Drop	1.04			
Ethylene Glycol				
Cooling Capacity	0.9935	0.9895	0.985	0.981
Heating Capacity	0.9865	0.9795	0.973	0.965
Pressure Drop	1.10	1.16	1.22	1.27
Methanol				
Cooling Capacity	0.985	–	–	–
Heating Capacity	0.9825	–	–	–
Pressure Drop	1.04	–	–	–
Propylene Glycol				
Cooling Capacity	0.985	0.975	0.965	0.955
Heating Capacity	0.981	0.9685	0.952	0.936
Pressure Drop	1.11	1.20	1.31	1.40

Vertical Units

Table 28: Unit sizes 007 through 030

Description	Unit Size						
	007	009	012	015	019	024	030
Compressor Type	Rotary					Scroll	
Refrigeration Charge (Oz.)	26		29	42		56	54
Fan Wheel (D x W)	6" x 8"			9" x 7"			
Fan Motor HP	1/10			1/3			1/2
Water Connection Size (FPT)	1/2"			3/4"			
Desuperheater Connection Size (FPT)	N/A	N/A	N/A	N/A	N/A	1/2"	
Coax & Water Piping Volume (Gal. @ 70°F)	0.2			0.5			
Condensate Connection Size (FPT)	3/4						
Air Coil Face Area (Sq Ft.)	2.1			2.5		4.1	
Waterside Economizer Coil Volume (Gal.)	0.75			0.85		1.33	
Hydronic Heat Section	Shipping Weight (Lbs.)		30		39		58
	Operating Weight (Lbs.)		34		44		68
	Coil Volume (Gal.)		0.43		0.57		1.15
Nominal Filter Size	17" x 21"			18" x 24"		28" x 22"	
Operating Weight	148	151		201	202	231	233
Shipping Weight	170	173		220	221	265	267

Table 29: Unit sizes 036 through 070

Description	Unit Size				
	036	042	048	060	070
Compressor Type	Scroll				
Refrigeration Charge (Oz.)	72	90	88	120	122
Fan Wheel (D x W)	11" x 10"				
Fan Motor HP	1/2	3/4		1	
Water Connection Size (FPT)	3/4"	1"			
Desuperheater Connection Size (FPT)	1/2"				
Coax & Water Piping Volume (Gal. @ 70°F)	0.5		1.1	2.1	
Condensate Connection Size (FPT)	3/4				
Air Coil Face Area (Sq Ft.)	4.9	5.6		6.4	
Waterside Economizer Coil Volume (Gal.)	1.56	1.88		2.03	
Hydronic Heat Section	Shipping Weight (Lbs.)		60		
	Operating Weight (Lbs.)		68		
	Coil Volume (Gal.)		1.01		
Nominal Filter Size	29" x 26"		30" x 29"		34" x 29"
Operating Weight	313	350	352	470	477
Shipping Weight	344	382	384	496	503

Horizontal Units

Table 30: Unit sizes 007 through 030

Description	Unit Size						
	007	009	012	015	019	024	030
Compressor Type	Rotary				Scroll		
Refrigeration Charge (Oz.)	26		29	42		56	54
Fan Wheel (D x W)	6" x 8"			9" x 7"			
Fan Motor HP	1/10			1/3		1/2	
Water Connection Size (FPT)	1/2"			3/4"			
Desuperheater Connection Size (FPT)	1/2"						
Coax & Water Piping Volume (Gal. @ 70°F)	0.2			0.5			
Condensate Connection Size (FPT)	3/4"						
Air Coil Face Area (Sq Ft.)	2.1			2.5		4.1	
Waterside Economizer Coil Volume (Gal.)	0.64			0.85		1.28	
Nominal Filter Size	15" x 21"			18" x 24"		17" x 34"	
Operating Weight	148	151	154	200	214	254	256
Shipping Weight	165	168	171	214	228	289	291

Table 31: Unit sizes 036 through 070

Description	Unit Size				
	036	042	048	060	070
Compressor Type	Scroll				
Refrigeration Charge (Oz.)	72	90	88	120	122
Fan Wheel (D x W)	11" x 10"				
Fan Motor HP	1/2	3/4		1	
Water Connection Size (FPT)	3/4"	1"			
Desuperheater Connection Size (FPT)	1/2"				
Coax & Water Piping Volume (Gal. @ 70°F)	1.1	1.2		2.1	
Condensate Connection Size (FPT)	3/4"				
Air Coil Face Area (Sq Ft.)	5.0	5.6		6.4	
Waterside Economizer Coil Volume (Gal.)	1.59	1.84		2.09	
Nominal Filter Size	19" x 37"	19" x 43"		19" x 48"	
Operating Weight	329	365	367	472	478
Shipping Weight	361	408	410	514	521

Table 32: Horizontal unit corner weights, percentage of total operating weight (Base unit only)

Unit Size	Total Operating Weight (lbs.)	Corner Weight % of Total Operating Weight			
		A	B	C	D
007	148	30%	20%	20%	30%
009	151				
012	154				
015	200				
019	214				
024	254				
030	256				
036	329				
042	365				
048	367				
060	472				
070	478				

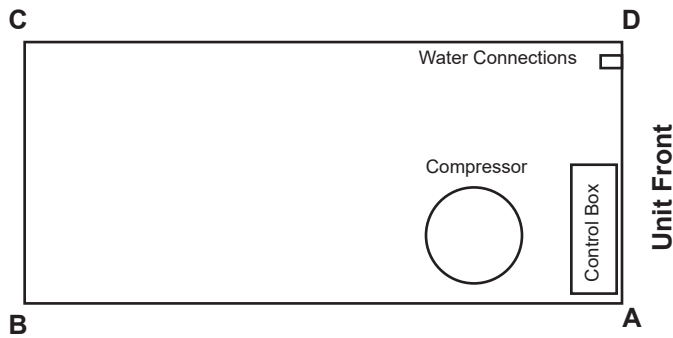

Horizontal Unit – Size 007, 009 & 012

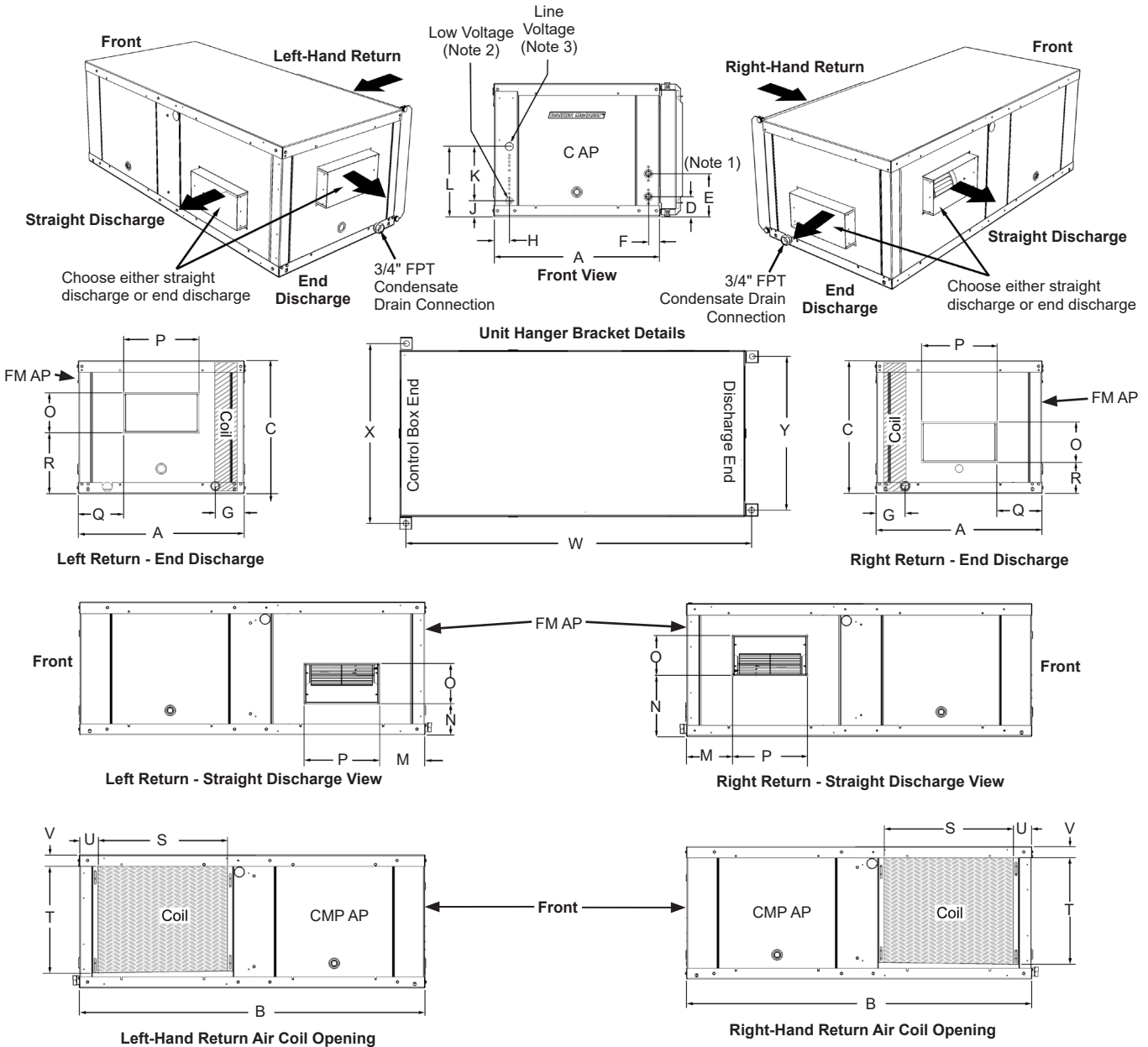

Table 33: Cabinet dimensions – sizes 007, 009, 012

GSH-Horizontal Unit	Overall Cabinet Dimensions in inches (mm)			Hanger Bracket Location Dimensions		
	A = Width	B = Length	C = Height	W	X	Y
007, 009, 012	21.60 (549)	45.00 (1143)	17.30 (439)	44.67 (1135)	23.60 (599)	19.10 (485)

Notes: All dimensions within ± 0.10 inches (2.5 mm).

Legend: **CMP AP** = Compressor Compartment Access Panel
C AP = Control Access Panel
FM AP = Fan Motor Access Panel

Table 34: Piping connections dimensions – sizes 007, 009, 012

GSH Horizontal Unit	Piping Connections in inches (mm)				Electrical Connections in inches (mm)			
	D	E	F	G	H	J	K	L
	Supply	Return		Condensate Drain 3/4" FPT		Low Voltage ²	Between	Line Voltage ³
007, 009, 012 ¹	2.65 (67)	5.65 (144)	1.47 (37)	3.76 (96)	1.98 (50)	2.08" (53)	7.06 (179)	9.14 (232)

Notes: ¹ Supply and return piping connections = 1/2" (13 mm) FPT.

² Low voltage opening = 7/8" (22 mm) diameter.

³ Line voltage opening = 1-1/8" (29 mm) diameter.

Table 35: Discharge duct & return air coil opening dimensions – sizes 007, 009, 012

GSH Horizontal Unit	Discharge Air Duct Connection in inches (mm)							Return Air Coil Opening in inches (mm)				
	M	N		O	P	Q	R		S	T	U	V
		Left-hand	Right-hand				Left-hand	Right-hand				
007, 009, 012	6.18 (157)	4.25 (108)	8.09 (206)	4.89 (124)	9.45 (240)	6.12 (156)	8.09 (206)	4.25 (108)	16.82 (427)	13.56 (344)	2.45 (62)	1.50 (38)

Note: All duct dimensions are referenced from the outside edge of the flange.

Figure 29: 2" filter rack assembly & duct collar dimensions – Sizes 007, 009, 012

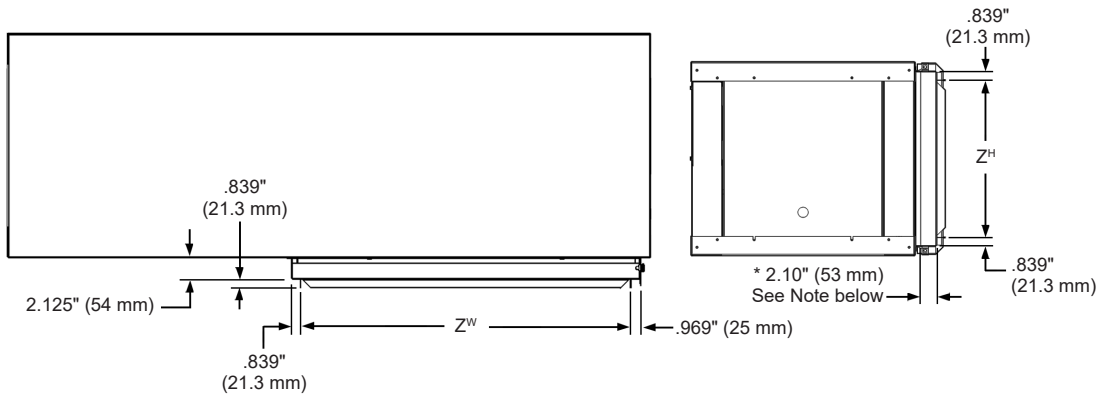

Note: * Optional 4" filter rack = 4.10" (104 mm).

Table 36: 2" filter rack assembly & duct collar dimensions – sizes 007, 009, 012

Unit Size	Z ^h	Z ^w
007, 009, 012	13.91 (353)	19.35 (491)

Horizontal Unit – Sizes 015 through 070

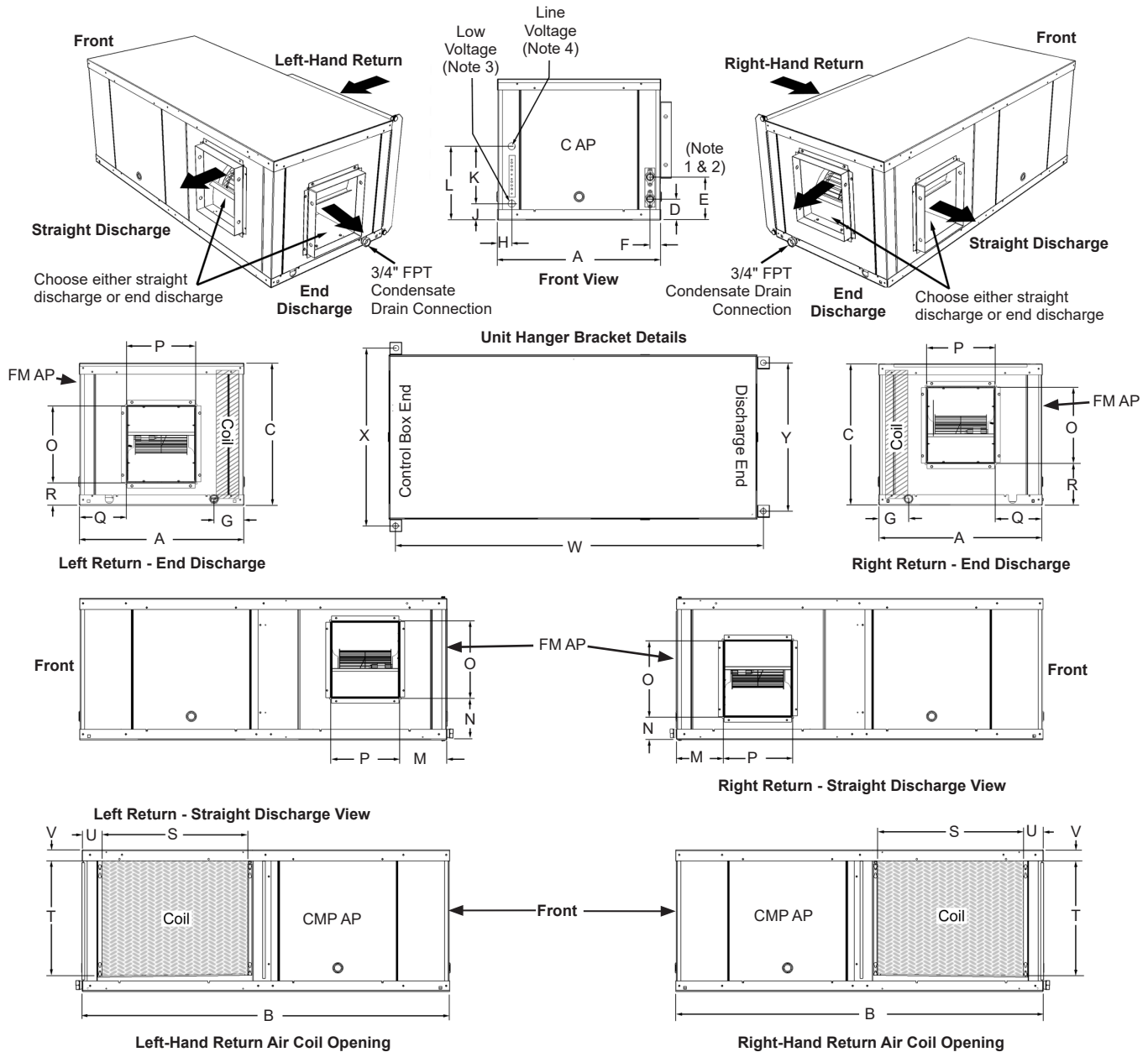

Table 37: Cabinet dimensions – sizes 015 through 070

GSH-Horizontal Unit	Overall Cabinet Dimensions in inches (mm)			Hanger Bracket Location Dimensions		
	A = Width	B = Length	C = Height	W	X	Y
015, 019	22.40 (569)	50.30 (1278)	19.30 (490)	50.06 (1272)	24.40 (620)	19.90 (505)
024, 030	22.40" (569)	63.30" (1608)	19.30" (490)	62.16 (1579)	23.90 (607)	18.64 (474)
036	25.00" (635)	73.00" (1854)	21.30" (541)	72.16" (1833)	27" (686)	21.24" (539)
042, 048	25.00" (635)	78.40" (1991)	21.30" (541)	77.57" (1970)	27" (686)	21.24" (539)
060, 070	25.00" (635)	83.80" (2129)	21.30" (541)	82.97" (2107)	27" (686)	21.24" (539)

Notes: All dimensions within ± 0.10 inches (2.5 mm).

Legend: **CMP AP** = Compressor Compartment Access Panel
C AP = Control Access Panel
FM AP = Fan Motor Access Panel

Table 38: Piping connections dimensions – sizes 015 through 070

GSH Horizontal Unit	Piping Connections in inches (mm)				Electrical Connections in inches (mm)			
	D	E	F	G	H	J	K	L
	Supply	Return		Condensate Drain 3/4" FPT		Low Voltage ³	Between	Line Voltage ⁴
015, 019 ¹	2.95 (75)	5.95 (151)	1.47 (37)	4.07 (103)	1.98 (50)	2.08 (53)	7.06 (179)	9.14 (232)
024, 030 ¹	2.58 (66)	13.39 (340)	1.57 (40)	4.29 (109)	1.94 (49)	2.57 (65)	7.36 (187)	9.93 (252)
036 ¹	2.76 (70)	13.57 (345)	1.57 (40)	4.36 (111)	1.94 (49)	3.57 (91)	8.23 (209)	11.81 (300)
042, 048 ²	3.07 (78)	13.88 (353)	1.57 (40)	4.36 (111)	1.94 (49)	3.57 (91)	8.23 (209)	11.81 (300)
060, 070 ²	3.07 (78)	13.88 (353)	1.57 (40)	4.36 (111)	1.94 (49)	3.57 (91)	8.23 (209)	11.81 (300)

- Notes:**
- ¹ Supply and return piping connections = 3/4" (19 mm) FPT.
 - ² Supply and return piping connections = 1" (25.4 mm) FPT.
 - ³ Low voltage opening = 7/8" (22 mm) diameter.
 - ⁴ Line voltage opening = 1-1/8" (29 mm) diameter.

Table 39: Discharge duct & return air coil opening dimensions – sizes 015 through 070

GSH Horizontal Unit	Discharge Air Duct Connection in inches (mm)							Return Air Coil Opening in inches (mm)				
	M	N		O	P	Q	R		S	T	U	V
		Left-hand	Right-hand				Left-hand	Right-hand				
015, 019	4.64 (118)	5.75 (146)	3.15 (80)	10.46 (266)	9.33 (237)	4.63 (118)	3.15 (80)	5.75 (146)	19.94 (507)	15.62 (398)	2.73 (69)	1.50 (38)
024, 030	4.41 (112)	6.20 (157)	2.71 (69)	10.39 (264)	9.32 (237)	4.41 (112)	2.71 (69)	6.20 (157)	32.50 (826)	15.45 (392)	1.97 (50)	1.93 (49)
036	4.88 (124)	4.74 (120)	2.81 (71)	13.75 (349)	13.25 (337)	4.88 (124)	2.81 (71)	4.74 (120)	35.75 (908)	17.45 (443)	1.97 (50)	1.93 (49)
042, 048	4.88 (124)	4.74 (120)	2.81 (71)	13.75 (349)	13.25 (337)	4.88 (124)	2.81 (71)	4.74 (120)	41.15 (1045)	17.45 (443)	1.97 (50)	1.93 (49)
060, 070	4.88 (124)	4.74 (120)	2.81 (71)	13.75 (349)	13.25 (337)	4.88 (124)	2.81 (71)	4.74 (120)	46.56 (1183)	17.45 (443)	1.97 (50)	1.93 (49)

Note: All duct dimensions are referenced from the outside edge of the flange.

Table 40: 2" filter rack assembly & duct collar dimensions – sizes 015 through 070

Unit Size	Z ^H	Z ^W
015, 019	16.49 (419)	23.38 (594)
024, 030	15.45 (392)	32.51 (826)
036	17.45" (443)	35.76" (908)
042, 048	17.45 (443)	41.15" (1045)
060, 070	17.45 (443)	46.55" (1182)

Figure 30: 2" filter rack assembly & duct collar dimensions – sizes 015 through 070

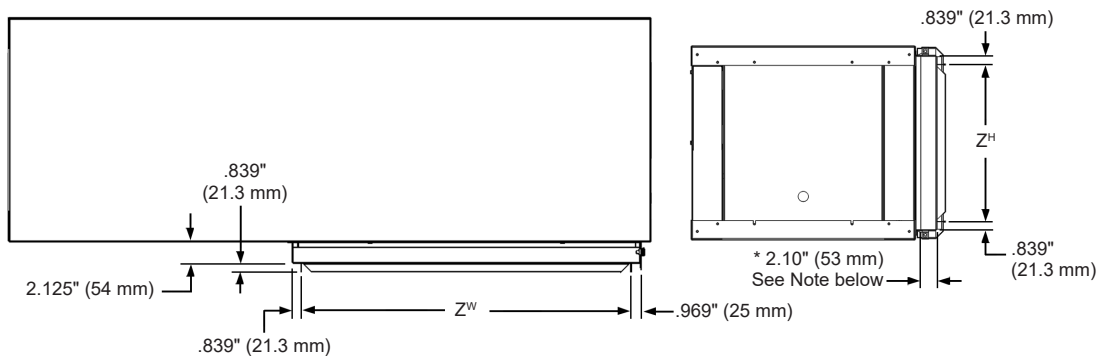

Note: * Optional 4" filter rack = 4.10" (104 mm).

Vertical Unit

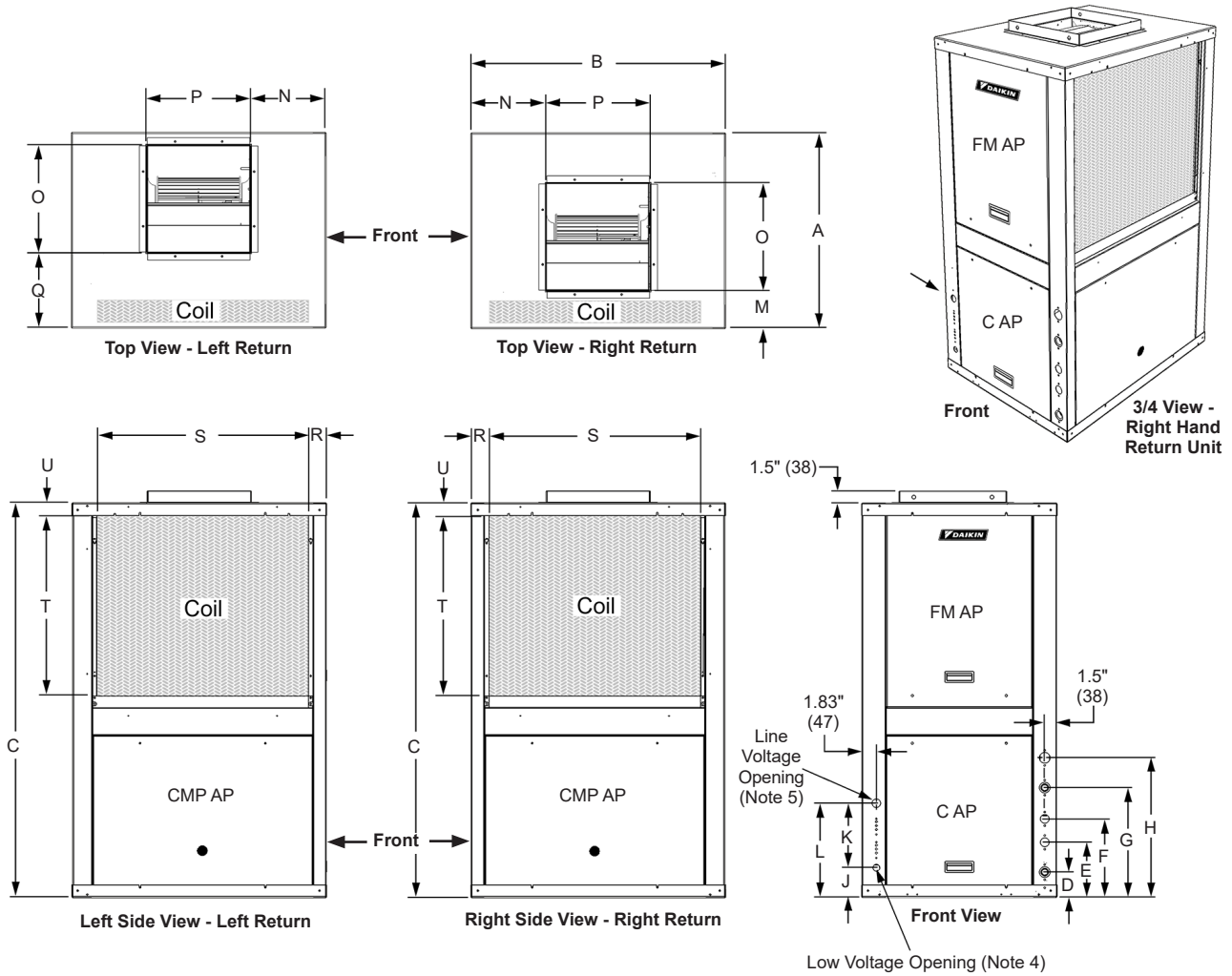

Table 41: Overall cabinet dimensions

GSV-Vertical Unit	Overall Cabinet Dimensions in inches (mm)		
	A = Width	B = Depth	C = Height
007, 009, 012	21.60 (549)	22.65 (575)	34.50 (876)
015, 019	22.40 (569)	25.60 (650)	37.50 (953)
024, 030	22.40" (569)	26.00" (660)	48.00" (1219)
036	25.00" (635)	32.50" (826)	50.50" (1283)
042, 048	25.00" (635)	32.50" (826)	54.50" (1384)
060, 070	25.00" (635)	32.50" (826)	58.50" (1486)

Notes: All dimensions within ± 0.10 inches (2.5 mm).

Legend: **CMP AP** = Compressor Compartment Access Panel
C AP = Control Access Panel
FM AP = Fan Motor Access Panel

Table 42: Piping & electrical connections dimensions

GSV Vertical Unit	Piping Connections in inches (mm)					Electrical Connections in inches (mm)		
	D	E	F	G	H	J	K	L
	Supply	Desuperheater Water Supply	Desuperheater Water Return	Return	Condensate Drain 3/4" FPT	Low Voltage ⁴	Between	Line Voltage ⁵
007, 009, 012 ¹	2.62 (67)	N/A	N/A	5.62 (143)	13.14 (334)	2.08 (53)	7.06 (179)	9.14 (232)
015, 019 ²	2.90 (74)	N/A	N/A	5.90 (150)	16.08 (408)	2.08 (53)	7.06 (179)	9.14 (232)
024, 030 ²	2.58 (66)	6.68 (170)	9.68 (246)	13.39 (340)	17.39 (442)	3.07 (78)	8.00 (203)	11.07 (281)
036 ²	3.26 (83)	7.07 (180)	10.07 (256)	14.07 (357)	17.88 (454)	3.82 (97)	8.25 (210)	12.07 (307)
042, 048 ³	3.07 (78)	7.07 (180)	10.07 (256)	13.88 (353)	17.88 (454)	3.82 (97)	8.25 (210)	12.07 (307)
060, 070 ³	3.07 (78)	7.07 (180)	10.07 (256)	13.88 (353)	17.88 (454)	3.82 (97)	8.25 (210)	12.07 (307)

- Notes:**
- ¹ Supply and return piping connections = 1/2" (13 mm) FPT.
 - ² Supply and return piping connections = 3/4" (19 mm) FPT.
 - ³ Supply and return piping connections - 1" (25.4 mm) FPT.
 - ⁴ Low voltage opening = 7/8" (22 mm) diameter.
 - ⁵ Line voltage opening = 1-1/8" (29 mm) diameter.

Table 43: Discharge duct collar & return air coil opening dimensions

GSV Vertical Unit	Discharge Duct Collar Connection in inches (mm)					Return Air Coil Opening in inches (mm)			
	M	N	O	P	Q	R	S	T	U
007, 009, 012	10.63 (270)	6.64 (169)	4.89 (124)	9.37 (238)	10.68 (271)	2.50 (63)	16.77 (426)	15.82 (402)	1.25 (32)
015, 019	5.75 (146)	8.16 (207)	10.45 (265)	9.33 (237)	10.43 (265)	2.61 (66)	19.71 (501)	16.15 (410)	1.25 (32)
024, 030	5.75 (146)	8.37 (213)	10.39 (264)	9.32 (237)	10.55 (268)	2.87 (73)	20.50 (521)	25.45 (646)	1.62 (41)
036	6.44 (164)	9.63 (245)	13.75 (349)	13.25 (337)	9.63 (245)	2.25 (57)	27.00 (686)	23.10 (587)	1.62 (41)
042, 048	6.44 (164)	9.63 (245)	13.75 (349)	13.25 (337)	9.63 (245)	2.25 (57)	27.00 (686)	27.10 (688)	1.62 (41)
060, 070	6.44 (164)	9.63 (245)	13.75 (349)	13.25 (337)	9.63 (245)	2.25 (57)	27.00 (686)	31.10 (790)	1.62 (41)



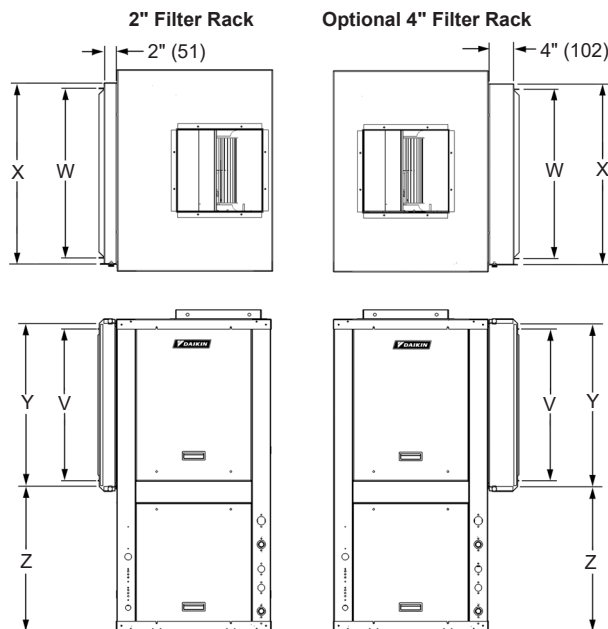

Table 44: Filter rack assembly & return air duct collar dimensions

Unit Size	V	W	X	Y	Z
007, 009, 012	15.97 (406)	19.35 (492)	21.87 (555)	17.63 (448)	16.31 (414)
015, 019	16.49 (419)	22.25 (565)	24.07 (611)	18.14 (461)	18.74 (476)
024, 030	26.48" (673)	20.78" (528)	22.62" (575)	28.15 (715)	19.09 (485)
036	24.57" (624)	27.38" (696)	29.22" (742)	26.25 (667)	23.50 (597)
042, 048	28.57" (726)	27.38" (696)	29.22" (742)	30.25 (768)	23.50 (597)
060, 070	32.57" (827)	27.38" (696)	29.22" (742)	34.25 (870)	23.50 (597)







Thermostats and Remote Indoor Sensor

Table 45: Thermostat Selections

Wall Mounted Thermostats & Remote Sensor for use with all WSHP units: Console, V-Stack, Enfinity & SmartSource models		Thermostats				Remote Sensor
		Non-Programmable	Programmable (7 Day or 5+1+1) Non-Programmable		7 Day Programmable Non-Programmable	Remote Indoor Thermostat Sensor
		2H/2C	2H/2C	2H/3C Humidity Control	2H/3C Humidity Control WIFI	
						
Daikin Part Number		910411879	910411880	910417943	910417944	910420874
Feature						
LCD Display	Room Temperature & Setpoint	•	•	•	•	Allows Remote Temperature Sensing
	Room Humidity %			•	•	
Glow in the dark Display light		•	•	•	•	
Operating Modes	System	Heat-Off-Cool-Auto	Heat-Off-Cool-Auto	Heat-Off-Cool-Auto	Heat-Off-Cool-Auto	
	Fan	On-Auto	On-Auto	On-Auto-IAQ	On-Auto-IAQ	
Changeover	Manual	•	•	•	•	Use up to 16 sensors for temperature averaging
	Auto	•	•	•	•	
Temperature Control Range		44° F to 90° F (7° C to 32° C)	44° F to 90° F (7° C to 32° C)	44° F to 90° F (7° C to 32° C)	44° F to 90° F (7° C to 32° C)	
Adjustable Setpoint Limits		•	•	•	•	
Keypad Lockout				•	•	
Filter Change Reminder			•	•	•	
Programmable Fan		•	•	•	•	
Power Type	Battery	2 AA Alkaline Batteries				
	Hardwire (Common Wire)	18 to 30 VAC	18 to 30 VAC	18 to 30 VAC	18 to 30 VAC	
Permanent Memory Retention		•	•	•	•	
Remote Indoor Sensor Capable (Requires Daikin P/N: 910420874)			•	•	•	
Terminals		Rh, RC, G, Y, Y2, C, O, B, W/E, W2	Rh, RC, C, Y, Y2, W/E, W2, G, B, O, S1, S2	Rh, RC, C, Y, Y2, W/E, W2, G, B, O, S1, S2, H, D	Rh, RC, C, Y, Y2, W/E, W2, G, B, O, S1, S2, H, D	
Application						
Dehumidification	Smart Dehumidification			•	•	
	Simplified	•	•	•	•	
	Humidistat Controlled			•	•	
Electric Heat	Boilerless	•	•	•	•	
	Supplemental	•	•	•	•	
	Primary	•	•	•	•	
Waterside Economizer		•	•	•	•	
Hydronic Heat		•	•	•	•	

Room Temperature Sensors

Table 46: Room Temperature Sensors for BAS Operation

Room Sensors for use with all WSHP units with a BACnet or LonWorks Communication Module: Console, V-Stack, Enfinity & Smart-Source models		Room Temperature Sensors			
		Basic Room Sensor	Cool to Warm Adjust	Digitally Adjustable Display Sensor	
					
		Temperature Sensing, LED Status Indication, Override/Reset Button	Cool/Warm Temperature Sensing Adjustment, LED Status Indication, Override/Reset Button	Temperature, Occupancy, Alarm, Setpoint and Status display, Override/Reset and Occupied/Unoccupied Buttons	Temperature, Humidity, Occupancy, Alarm, Setpoint and Status display, Override/Reset and Occupied/Unoccupied Buttons
Daikin Part Number		910152149	910171464	910152147	910121754
Feature					
Setpoint Adjustment		None	Cool to Warm	Digitally Adjustable	Digitally Adjustable
Display	Room Temperature & Setpoint			•	•
	Room Humidity & Setpoint				•
Stages	Heating	4	4	4	4
	Cooling	3	3	3	3
Operating Modes	System				Heat-Off-Cool-Auto Dehumidify
	Fan				On-Auto
	Occupancy			LCD Display of Occupied-Unoccupied Icon	LCD Display of Occupied-Unoccupied Icon
Annunciation	Status LED	•	•	LCD Display of Unit Status	LCD Display of Unit Status
	LCD Alarm Display			•	•
Reset	Alarm	•	•	•	•
	Setback Override	•	•	•	•
Application					
Dehumidification	Smart Dehumidification				•
Electric Heat	Boilerless	•	•	•	•
	Supplemental	•	•	•	•
	Primary	•	•	•	•
Waterside Economizer		•	•	•	•
Hydronic Heat		•	•	•	•

Horizontal Unit

General

Units shall be supplied completely factory assembled, piped, internally wired, fully charged with R-410A and capable of operation with an entering water temperature range from 55°F to 120°F on water loop models, 20°F to 120°F on geothermal ground loop and ground water models. All equipment must be rated and certified in accordance with ARI / ISO 13256-1 and must be tested, investigated, and determined to comply with the requirements of the standards for Heating and Cooling Equipment UL-1995 for the United States and CAN/CSA-C22.2 NO.236 for Canada. The units shall have AHRI/ISO and ETL-US-C labels. Each unit shall be run tested at the factory. The installing contractor shall be responsible for furnishing and installing Daikin Water Source Heat Pumps as indicated on the plans and per installation instructions.

Electrical

A control box shall be located within the unit and shall contain controls for compressor, reversing valve and fan motor operation and shall have either, a 50VA or 75VA transformer and a terminal block for low voltage field wiring connections. Unit shall be name-plated to accept time delay fuses or HACR circuit breaker for branch over-current protection of the power source. Unit control system shall provide heating or cooling as required by the set points of the wall thermostat. The unit control scheme shall provide for fan operation simultaneous with compressor operation (fan interlock) regardless of the thermostat type. The unit shall be capable of providing an output signal to an LED on the thermostat or to a central monitoring panel to indicate a "fault" condition from the activation of any one of the safety switches.

Casing and Cabinet

The outer cabinet shall be powder-coat painted as standard color textured paint.

- **Factory-installed option:** Unpainted cabinet
- **Factory-installed option:** Powder-coat painted color "off white"

Cabinets shall have separate openings and knockouts for entrance of line voltage and low voltage control wiring. Supply and return water connections shall be FPT fittings and shall be securely mounted flush to the cabinet corner post allowing for connection to a flexible hose without the use of a back-up wrench.

It is the installing contractor's responsibility to provide sufficient clearance so that units can be easily removed for servicing.

The cabinet shall be fabricated from heavy gauge G-60 galvanized sheet metal with interior surfaces lined with the following insulation options:

Standard insulation in the compressor compartment shall be 1/2" fiberglass – multicoated type. Standard insulation on the air side shall be 1/2" fiberglass cleanable foil faced type with edges sealed or tucked in order to prevent introduction of fibers into the discharge air. Standard cabinet insulation must meet NFPA 90A requirements, air erosion and mold growth limits of UL-181, fungal resistance test per ASTM-C1071 and ASTM G21, and shall meet zero level bacteria growth per ASTM G22. All insulation shall have a flame spread of less than 25 and a smoke developed classification of less than 50 per ASTM E-84 and UL 723.

- **Factory-installed option 1:** Standard Insulation Package
 - 1/2-inch fiberglass skin-face in compressor section, 1/2-inch foil-face insulation in airside section
- **Factory-installed option 2 :** Indoor Air Quality Insulation Package
 - 3/8-inch closed cell foam in compressor and airside sections
- **Factory-installed option 3 :** Sound Reduction Package
 - 3/4-inch sound sound insulation in compressor and airside sections (Unit Sizes 007 - 019)
 - 1/2-inch fiberglass skin-face in compressor section with compressor sound blanket and 3/4-inch sound insulation in airside section (Unit Sizes 024 - 070)
- **Factory-installed unit application options:**
 - Water Loop (WL)-14°F suction line temp sensor with no insulation on refrigerant lines or coax or water lines
 - Ground Water (GW)-14°F suction line temp sensor with closed cell insulated refrigerant lines, coaxial condenser, and water lines
 - Ground Loop (GL)-7°F suction line temp sensor with closed cell insulated refrigerant lines, coaxial condenser, and water lines

Airflow Configurations

Units shall be configured in one of the following airflow arrangements:

- Left Return/End Discharge
- Left Return/Straight Discharge
- Right Return/End Discharge
- Right Return/Straight Discharge

Units shall have a factory-installed, 4-sided, 1" duct flange on the discharge of the blower to allow connection of field ductwork and must have a minimum of two access panels, one for the compressor compartment and one for the blower compartment. Unit shall have an insulated panel separating the blower compartment from the compressor compartment. Units are to ship with heavy metal brackets, rubber isolators, fasteners and washers to suspend and isolate the unit from the building.

Stainless Steel Drain Pan

Unit shall utilize corrosion resistant closed-cell insulated stainless steel drain pans. A stub out connection shall be provided. The drain pan shall be designed to ensure no pooling of condensate water per ASHRAE 62.2. The unit will be supplied with solid-state electronic condensate overflow protection as standard. Mechanical float switches will not be accepted.

Filter Rack and Filters

Unit shall come standard with a 2-inch disposable filter and a 2-inch, 4-sided factory-installed combination filter rack/return air duct collar. The filters shall be removable from either side of the unit.

As selectable options, unit shall have a 2-inch thick MERV 8 OR 4 inch MERV 13 filter, factory-installed with a 2-inch or 4- inch factory-installed combination filter rack/return air duct collar.

The optional factory-installed hi-MERV seal shall provide a leakage rate of less than 4 CFM per square foot of filter area at .5" ESP.

As factory installed options, units shall be available with no filter and filter rack, or no filter.

All filter racks shall be 4-sided with door and duct collar.

Fan and Motor Assembly

The fan shall be a centrifugal, direct drive type, utilizing a variable speed EC fan motor with soft start. The Fan motor shall be isolated from the housing by rubber isolation grommets, and shall be permanently lubricated and have thermal overload protection. The fan housing shall have a removable orifice ring to facilitate removal of the fan motor and fan wheel assembly, and the fan housing shall protrude through the cabinet to facilitate a field-supplied duct connection.

The EC motor shall maintain constant CFM over its static operating range. The fan and motor assembly must be capable of overcoming the external static pressures as shown on the schedule.

For unit sizes 015 – 070, the constant CFM EC motor shall deliver precise speed and economical performance up to the maximum published static pressure. Unit sizes 007 – 012 shall utilize a constant torque EC motor type.

Field adjustable air flow from an easily accessible 4-speed selector switch, located in the unit control box, shall allow for manual setting of the optimal fan speed specific to the application.

Disconnect Switch

This factory-installed option shall include the addition of a 3-pole switch mounted on the unit. The switch shall have a lockout/tag out feature. The switch shall be rated to be added to all units to handle the unit only (not to include units with optional factory-mounted electric heat). The switch shall be rated to handle all the voltages available for the unit. (460/3/60 requires 4-wire power service).

Water Pressure Differential Switch

Available as a factory installed option, a pressure differential switch monitoring the water pressure drop across the heat exchanger shall be factory mounted internal to the cabinet and shall disable compressor operation if flow is not detected.

Refrigerant Circuit

Units shall have a sealed refrigerant circuit, which includes a non-CFC depleting R-410A refrigerant [rotary (sizes 007 – 019), and scroll compressors (sizes 024 to 070)]. In addition, each unit will have a thermostatic expansion valve, an aluminum fin and rifled copper tube refrigerant-to-air heat exchanger, a reversing valve and a water-to-refrigerant coaxial heat exchanger. The coaxial coils shall be made of [copper] [or optional cupronickel] and shall be deeply fluted to enhance heat transfer and minimize fouling and scaling. The coaxial coil shall have a working pressure of 500 psig on the waterside of the unit and 600 psig on the refrigerant side for all R-410A units.

The compressor shall have a dual level vibration isolation system. The compressor will be mounted on vibration isolation grommets to a heavy gauge compressor mounting plate, which is then isolated from the cabinet base with rubber grommets to minimize vibration transfer. Compressor shall have thermal overload protection. Compressor shall be located in an insulated compartment away from air stream to minimize sound transmission.

Refrigerant metering shall be regulated by a thermostatic expansion valve (TXV) only. Reversing valve shall be four-way solenoid activated refrigerant valve, which fails in the cooling “dominant” operation. Safety controls include a high-pressure switch, a low-pressure switch, and a low refrigerant temperature sensor. Refrigerant gauge access fittings shall be factory-installed on high and low pressure refrigerant lines to facilitate field service. Activation of any safety switch shall prevent the compressor from operating.

All air coils shall be coated with an optional inorganic, silicon-based nano-ceramic coating that must pass a ASTM B117 3,000 hour salt spray test to provide protection against corrosion due to acids, solvents, and salt found in the environment.

Hot Gas Reheat Smart Dehumidification Option

The optional factory-installed hot gas reheat coil shall be used as part of a dehumidification operating sequence. Hot gas reheat shall be enabled when the space humidity level is above a user selectable set point, typically, 50 to 55% RH. Superheated refrigerant gas shall be diverted to the reheat coil and unit fan shall operate at dehumidification fan speed upon a call for dehumidification. This option includes a hot gas reheat coil and a solenoid actuated 3-way valve. Coil shall be proof and leak tested. A corrosion resistant coated hot gas reheat coil shall be available as an option.

Simplified Dehumidification Option

Available as a factory-installed option, unit shall be configured to allow for maximum latent capacity while decreasing room humidity levels by optimizing blower fan speed for dehumidification. Option requires a thermostat with a minimum of 2 cooling stages.

Humidistat Controlled Dehumidification Option

Available as a factory-installed option, unit shall be configured to allow for maximum latent capacity while decreasing room humidity levels by optimizing blower fan speed for dehumidification. Option requires a humidistat as well as a thermostat with a minimum of 1 cooling stage.

Dehumidification Always Option

Available as a factory-installed option, for cooling only applications, this option shall utilize a humidistat only. Upon a call from the humidistat, the unit shall be configured to run at dehumidification blower speed combined with maximum compressor speed, allowing for maximum latent capacity.

Waterside Economizer

A factory mounted and wired waterside economizer shall consist of a hydronic cooling coil located between the unit filter rack and evaporator, a 2-position 3-way diverting valve, a manual air vent, and an entering fluid sensor. The waterside economizer outer cabinet shall be powder-coat painted with standard color textured paint. The cabinet shall be fabricated from heavy gauge G-60 galvanized sheet metal with interior surfaces lined with a minimum 3/8-inch thick closed-cell non-fibrous IAQ insulation. Components shall be accessible without removing economizer. An insulated stainless steel drain pan compliant with ASHRAE 62.1 including electronic condensate overflow protection shall be provided. Economizer flush mounted piping connections shall be on the same side as the WSHP unit piping connections. Hose kits shall be provided for field connection of economizer to WSHP unit. For corrosive environment applications, a corrosion resistant coated coil shall be available.

The unit mounted control system shall allow economizer operation for either supplemental to mechanical unit cooling or independent, based on entering fluid temperature and refrigerant suction temperature operating conditions. Economizer operation shall be permitted when entering fluid temperature is below 55°F yet adjustable between 70°F to 50°F. Economizer operation shall be initiated from a 3-stage wall mounted thermostat or room temperature sensor. Economizer operation shall not be permitted when entering fluid temperature is below 35°F.

Motorized Water Isolation Valves

The optional 2-way motorized isolation valve shall be factory-installed inside the compressor compartment. The valve actuator shall be factory wired to the Micro-Tech III SmartSource controller and be controlled when there is a call for heating or cooling. The valve shall have an end switch to ensure valve is fully open prior to compressor operation.

External Loop Pump(s)

This option includes the addition of an externally mounted water pump on unit sizes 2 tons and larger. Single pump or dual pumps available. Pumps shall be piped in series. The pump(s) shall be able to produce nominal GPM (3 GPM/ton) and be able to overcome the internal pressure drop of the coax heat exchanger, plus 30 feet additional water pressure drop with 25% PG antifreeze solution.

Sound Package

Available as a factory installed option, unit sizes 024 – 070 shall utilize sound attenuating compressor blankets combined with high technology sound attenuating material that is strategically applied within the air handling compartment to further reduce sound transmitted by the unit while in operation. Unit sizes 007 – 019 shall have sound attenuating material in the compressor compartment in lieu of a compressor blanket. Compressor sound blanket is not recommended on a unit with a rotary compressor.

Water Pressure Differential Switch

Available as a factory installed option, a pressure differential switch monitoring the water pressure drop across the heat exchanger shall be factory mounted internal to the cabinet and shall disable compressor operation if flow is not detected.

Coaxial Coil Supply Liquid Auto Flow Regulator

This factory-installed option includes the addition of an automatic flow control valve to set and limit the GPM through the unit. The valve shall have a “replaceable cartridge” capability. The valve shall be rated for 600 psig. Note: This option will not be available with External Water Pump option.

Solid-State Control System

MicroTech III SmartSource Control System - Unit shall have a microprocessor- based control system. The unit control logic shall provide cooling, heating, smart dehumidification, and/or economizer operation as required by the thermostat and/or sensor. The control system shall provide the following for stand-alone operation:

1. The use of standard non-programmable or programmable wall thermostats.
2. Fan operation simultaneous with the compressor (fan interlock) regardless of thermostat logic.
3. Time delay compressor operation.
4. Compressor short cycle protection of a minimum of three minutes before restart is possible.
5. Random unit start-up
6. Single grounded wire connection for activation of the unoccupied or unit shutdown modes.
7. Night setback temperature setpoint input signal from the wall thermostat.
8. Override signal from wall thermostat to override unoccupied mode for 2 hours.
9. Brownout protection to suspend unit operation if the supply voltage drops below 80% of normal.
10. Condensate overflow protection to suspend cooling operation in an event of a full drain pan.
11. Suspended compressor operation upon activation of the refrigerant pressure switch(es).
12. Cooling operation activated for 60 seconds upon activation of the freeze fault or compressor low suction temperature alarms - defrost cycle.
13. Method of defeating compressor, reversing valve and fan time delays for fast service diagnostics.
14. Remote Alarm reset - Provides ability to remotely reset the unit upon a fault condition.
15. Fault Retry clears faults the first two times they occur within a 24-hour period and triggers automatic lock-out on third fault.
16. Control shall be configurable to accommodate thermostat or sensor based control.

Smart Fan Controls

All units shall have the capability of lowering the CFM as the space temperature approaches the thermostat setpoint, through smart fan controls. Smart fan controls shall allow variable airflow control, based on the call for 1st and 2nd stage heating or cooling.

Cooling Mode – On an initial call for cooling, the fan shall be energized at its “fan only” setting. After a 0 to 30 second random delay, the compressor and fan will start at the stage 1 cooling settings. If room setpoint conditions are not satisfied, the compressor and fan will operate at the stage 2 cooling settings. When the room setpoint conditions are satisfied, the compressor will shut off and the fan will operate according to its “fan

only” setting, when enabled for continuous fan operation. If fan cycling is enabled, the fan will turn off once room setpoint conditions are satisfied.

Heating Mode – On an initial call for heating, the fan shall energize at its “fan only” setting. After a 0 to 30 second random delay, the reversing valve is energized after 60 seconds, the compressor and fan will start at stage 1 heating settings. If room setpoint conditions are not satisfied, the compressor and fan will operate at stage 2 heating settings. When the room setpoint conditions are satisfied, the compressor will shut off and the fan will operate according to its “fan only” setting, when enabled for continuous fan operation. If fan cycling is enabled, the fan will turn off once room setpoint conditions are satisfied. The reversing valve will be de-energized 60 seconds later.

Smart Dehumidification Mode – (Optional for unit equipped with hot gas reheat) Uses hot gas reheat, a humidistat, a 2-stage thermostat and air flow management for precise humidity control. When the cooling and heating temperature setpoint is satisfied and there is a call for dehumidification, maximum dehumidification is initiated by energizing the fan at its “fan only” setting, energizing the pump request, energizing the 45 second proof-of-flow timer, energizing the hot gas reheat solenoid valve, energizing the compressor at maximum cooling, and energizing the fan at the dehumidification setting. When the room humidity conditions are satisfied, the compressor will shut off and the fan will operate according to its “fan only” setting, when enabled for continuous fan operation. If fan cycling is enabled, the fan will turn off once room humidity conditions are satisfied.

Supplemental Electric Heat Mode – (Optional for unit equipped with supplemental electric heat). On a call for heating, the fan will energize at its “fan only” setting, the pump request will energize, the 45 second flow timer will start. After the flow, compressor minimum off, and random startup timers are expired, the compressor and fan will start at stage 1 heating settings; the reversing valve shall energize 5 seconds after the compressor turns on. If room setpoint conditions are not satisfied, the fan will operate at stage 2 heating settings. If room setpoint conditions are still not satisfied, the compressor will continue to operate and stage 1 electric heat will be energized and the fan will operate at its electric heat setting. For units equipped with 2 stages of electric heat, if room setpoint conditions are still not satisfied, the second stage of electric heat will be energized and the fan will continue to operate at its electric heat setting. When the room setpoint conditions are satisfied, electric heat will be de-energized allowing the compressor to remain on if necessary to maintain room setpoint conditions. The fan will operate according to its “fan only” setting when enabled, for continuous fan operation. If fan cycling is enabled, the fan will turn off once room setpoint conditions are satisfied.

MicroTech™ III SmartSource Control with LONWORKS communication module – Unit shall have a microprocessor-based control system. The unit control logic shall communicate over a LONMARK communications network. The unit controller is factory programmed [LONMARK ® 3.4 certified Application Code the current standard for new applications] and tested with all the logic required to monitor and control heating and cooling operation. The controller sets the unit mode of operation, monitors water and air temperatures, and can communicate fault conditions via a LONMARK communications network. Units with the MicroTech III and LONWORKS communication module include return air, discharge air and leaving water temperature sensors. Space temperature sensor options include a set-point adjustment, tenant override button, and the capability of substituting the return air sensor with a wall-mounted room sensor.

MicroTech III SmartSource Control w/ BACnet Communication Module – Unit shall have a microprocessor-based control system. The unit control logic shall communicate over a BACnet communications network. The BACnet communication module shall incorporate an Atmel ARM7 Thumb series MCU and be capable of supporting a full MSTP BACnet implementation. The microprocessor shall also support SPI compatible communications with

the MCU of the MicroTech III SmartSource controller. The physical interface to a BACnet BAS network shall be through an industry standard RS-485 transceiver capable of existing on an RS-485 network of up to 64 nodes. The unit controller is factory programmed and tested with all the logic required to monitor and control heating and cooling operation. The controller sets the unit mode of operation, monitors water and air temperatures, and can communicate fault conditions via a BACnet communications network. Units outfitted with Microtech III and BACnet communication modules include return air, discharge air and leaving water temperature sensors. Space temperature sensor options include a set-point adjustment, tenant override button, and the capability of substituting the return air sensor with a wall-mounted room temperature sensor.

Each communicating unit controller performs the following unit operations:

- Enable heating and cooling to maintain space temperature set point at the room sensor
- Enable fan and compressor operation
- Monitor all safety controls
- Monitor discharge and return air temperature
- Monitor leaving water temperature
- Relay status of all vital unit functions
- Support optional control outputs

Unit mounted LED annunciators aid in diagnosing unit operation by indicating the water source heat pump operating mode and alarm conditions. If there are no current alarm conditions, a green LED on the annunciator board will indicate occupied unit operating mode. If an alarm condition exists, the Microtech III unit controller will send the fault condition to the LED annunciator, which will assist in troubleshooting the unit. Heat pumps with the MicroTech III Unit Controller with a LONWORKS Communication Module is designed to be linked with a centralized Building Automation System (BAS) through a LONMARK communications network for centralized scheduling and management of multiple heat pumps.

Wall-mounted room sensors are available to control the operation of each MicroTech III Water Source Heat Pump.

Warranty

- An optional 2, 3, or 4-year extended compressor warranty covers the compressor from the date at which the unit ships from the factory.
- An optional 2, 3, or 4-year extended refrigeration circuit warranty covers the entire refrigeration circuit and related components for 5 years.

Field Installed Accessories

Wall-Mounted Thermostats:

- Programmable Touch Screen Thermostat
 1. Optional Remote Room Sensor
 2. Optional Outdoor Temperature Sensor
- Non-Programmable Thermostat
 1. Optional Remote Room Sensor
- Programmable Thermostat
 1. Optional Remote Room Sensor

Wall-Mounted Room Temperature Sensors for BACnet and LonWorks Communications:

- Digitally Adjustable Wall Sensor with Temperature and Humidity Display
- Adjustable Cool/Warm with Occupancy Switch, Override/Reset Button, Status LED, Fan and System Switch
- Adjustable 55°-95°F and 12°-33°C, Override/Reset Button, Status LED, Fan and System Switch
- Adjustable -5°F to +5°F and -21°C to -15°C, Override/Reset Button, Status LED, Fan and System Switch
- Basic Sensor, Override/Reset Button, Status LED

Humidistat

To be used in conjunction with one of the dehumidification options. Humidistat to be wall mounted and capable of providing solid state input to unit controls to enable/disable dehumidification features.

Hose Kits

Supply and Return Hose Kits

Two fire-rated flexible hoses with ASTM ratings of Flame Spread 25, Fuel Contribution 25 and Smoke Density 50 for connection to unit and field piping. Hose shall be covered with stainless steel braiding to prevent damage.

The automatic flow hose kit shall include an automatic flow control valve, two ball valves, two flexible hoses, a high flow Y-strainer, and may include a strainer blow-down and various other accessories. The automatic flow control valve shall be factory set to a rated flow, and shall automatically control the flow to within 10% of the rated value over a 40 to 1 differential pressure, operating range (2 to 80 PSID). Operational temperature shall be rated from fluid freezing, to 225°F. The valve body shall be constructed from hot forged brass UNS C37700 per ASTM B-283 latest revision.

Jumper Hose Kit (Used with Waterside Economizer and Hydronic Heat)

The jumper hose kit used with waterside economizer and hydronic heat shall include a single UL-94 VO fire rated hose with 1-inch male JIC x 90 degree male pipe plated steel adapter.

Condensate Hose Kits

- Optional plastic hose including fittings
- Optional fire-rated, braided steel hose including fittings

Valve Options

- Optional 2-way, Normally Open (N.O.) or Normally Closed (N.C.) motorized valves.
- Optional 2-way, mechanical ball valve

Replacement Filters

2-inch MERV 8, 4 inch MERV 13, and 2-inch disposable filters shall be available as direct replacement to factory-installed filters.

Electric Heat Coils

An optional 5, 10, 15, or 20 kW field installed duct heater shall be available. These heaters will require a field provided power source. 15 and 20 kW heaters shall be 2-stage.

Vertical Unit

General

Units shall be supplied completely factory assembled, piped, internally wired, fully charged with R-410A and capable of operation with an entering water temperature range from 55°F to 110°F on water loop models, 30°F to 110°F on geothermal ground loop and ground water models. All equipment must be rated and certified in accordance with ARI / ISO 13256-1 and must be tested, investigated, and determined to comply with the requirements of the standards for Heating and Cooling Equipment UL-1995 for the United States and CAN/CSA-C22.2 NO.236 for Canada. The units shall have AHRI/ISO and ETL-US-C labels. Each unit shall be run tested at the factory. The installing contractor shall be responsible for furnishing and installing Daikin Water Source Heat Pumps as indicated on the plans and per installation instructions.

Electrical

A control box shall be located within the unit and shall contain controls for compressor, reversing valve and fan motor operation and shall have either, a 50VA or 75VA transformer and a terminal block for low voltage field wiring connections. Unit shall be name-plated to accept time delay fuses or HACR circuit breaker for branch over-current protection of the power source. Unit control system shall provide heating or cooling as required by the set points of the wall thermostat. The unit control scheme shall provide for fan operation simultaneous with compressor operation (fan interlock) regardless of the thermostat type. The unit shall be capable of providing an output signal to an LED on the thermostat or to a central monitoring panel to indicate a "fault" condition from the activation of any one of the safety switches.

Casing and Cabinet

The outer cabinet shall be powder-coat painted as standard color textured paint.

- Factory-installed option: Unpainted cabinet
- Factory-installed option: Powder-coat painted color "off white"

Cabinets shall have separate openings and knockouts for entrance of line voltage and low voltage control wiring. Supply and return water connections shall be FPT fittings and shall be securely mounted flush to the cabinet corner post allowing for connection to a flexible hose without the use of a back-up wrench.

It is the installing contractor's responsibility to provide sufficient clearance so that units can be easily removed for servicing.

The cabinet shall be fabricated from heavy gauge G-60 galvanized sheet metal with interior surfaces lined with the following insulation options:

Standard insulation in the compressor compartment shall be 1/2" fiberglass – multicoated type. Standard insulation on the air side shall be 1/2" fiberglass cleanable foil faced type with edges sealed or tucked in order to prevent introduction of fibers into the discharge air. Standard cabinet insulation must meet NFPA 90A requirements, air erosion and mold growth limits of UL-181, fungal resistance test per ASTM-C1071 and ASTM G21, and shall meet zero level bacteria growth per ASTM G22. All insulation shall have a flame spread of less than 25 and a smoke developed classification of less than 50 per ASTM E-84 and UL 723.

- **Factory-installed option 1:** Standard Insulation Package
 - 1/2-inch fiberglass skin-face in compressor section, 1/2-inch foil-face insulation in airside section
- **Factory-installed option 2:** Indoor Air Quality Insulation Package
 - 3/8-inch closed cell foam in compressor and air-side sections
- **Factory-installed option 3:** Sound Reduction Package
 - 3/4-inch sound insulation in compressor and airside sections (Unit Sizes 007 - 019)
 - 1/2-inch fiberglass skin-face in compressor section with compressor sound blanket (Unit Sizes 024 - 070) and 3/4-inch sound insulation in airside section
- **Factory-installed unit application options:**
 - Water Loop (WL)-14°F suction line temp sensor with no insulation on refrigerant lines or coax or water lines
 - Ground Water (GW)-14°F suction line temp sensor with closed cell insulated refrigerant lines, coaxial condenser, and water lines
 - Ground Loop (GL)-7°F suction line temp sensor with closed cell insulated refrigerant lines, coaxial condenser, and water lines

Airflow Configurations

Units shall be configured in one of the following airflow arrangements:

- Left Return/Top Discharge
- Right Return/Top Discharge

Units shall have a factory-installed, 4-sided, 1" duct flange on the discharge of the blower to allow connection of field ductwork and must have a minimum of two access panels, one for the compressor compartment and one for the blower compartment. Unit shall have an insulated panel separating the blower compartment from the compressor compartment. Units are to ship with heavy metal brackets, rubber isolators, fasteners and washers to suspend and isolate the unit from the building.

Stainless Steel Drain pan

Unit shall utilize corrosion resistant closed-cell insulated stainless steel drain pans. A stub out connection shall be provided. The drain pan shall be designed to ensure no pooling of condensate water per ASHRAE 62.2. The unit will be supplied with solid-state electronic condensate overflow protection as standard. Mechanical float switches will not be accepted.

Filter Rack and Filters

Unit shall come standard with a 2-inch disposable filter and a 2-inch, 4-sided factory-installed combination filter rack/return air duct collar. The filters shall be removable from either side of the unit.

As selectable options, unit shall have a 2-inch thick MERV 8 OR 4-inch MERV 13 filter, factory-installed with a 2-inch or 4-inch factory-installed combination filter rack/return air duct collar.

The optional factory-installed hi-MERV seal shall provide a leakage rate of less than 4 CFM per square foot of filter area at .5" ESP.

As factory installed options, units shall be available with no filter and filter rack, or no filter.

All filter racks shall be 4-sided with door and duct collar.

Fan and Motor Assembly

The fan shall be a centrifugal, direct drive type, utilizing a variable speed EC fan motor with soft start. The Fan motor shall be isolated from the housing by rubber isolation grommets, and shall be permanently lubricated and have thermal overload protection. The fan housing shall have a removable orifice ring to facilitate removal of the fan motor and fan wheel assembly, and the fan housing shall protrude through the cabinet to facilitate a field-supplied duct connection.

The EC motor shall maintain constant CFM over its static operating range. The fan and motor assembly must be capable of overcoming the external static pressures as shown on the schedule.

For unit sizes 015 – 070, the constant CFM EC motor shall deliver precise speed and economical performance up to the maximum published static pressure. Unit sizes 007 – 012 shall utilize a constant torque EC motor type.

Field adjustable air flow from an easily accessible 4-speed selector switch, located in the unit control box, shall allow for manual setting of the optimal fan speed specific to the application.

Water Pressure Differential Switch

Available as a factory installed option, a pressure differential switch monitoring the water pressure drop across the heat exchanger shall be factory mounted internal to the cabinet and shall disable compressor operation if flow is not detected.

Refrigerant Circuit

Units shall have a sealed refrigerant circuit, which includes a non-CFC depleting R-410A refrigerant [rotary (sizes 007-019), and scroll compressors (sizes 024 to 070)]. In addition, each unit will have a thermostatic expansion valve, an aluminum fin and rifled copper tube refrigerant-to-air heat exchanger, a reversing valve and a water-to-refrigerant coaxial heat exchanger. The coaxial coils shall be made of [copper] [or optional cupronickel] and shall be deeply fluted to enhance heat transfer and minimize fouling and scaling. The coaxial coil shall have a working pressure of 500 psig on the waterside of the unit and 600 psig on the refrigerant side for all R-410A units.

The compressor shall have a dual level vibration isolation system. The compressor will be mounted on vibration isolation grommets to a heavy gauge compressor mounting plate, which is then isolated from the cabinet base with rubber grommets to minimize vibration transfer. Compressor shall have thermal overload protection. Compressor shall be located in an insulated compartment away from air stream to minimize sound transmission.

Refrigerant metering shall be regulated by a thermostatic expansion valve (TXV) only. Reversing valve shall be four-way solenoid activated refrigerant valve, which fails in the cooling “dominant” operation. Safety controls include a high-pressure switch, a low-pressure switch, and a low refrigerant temperature sensor. Refrigerant gauge access fittings shall be factory-installed on high and low pressure refrigerant lines to facilitate field service. Activation of any safety switch shall prevent the compressor from operating.

All air coils shall be coated with an optional inorganic, silicon-based nano-ceramic coating that must pass a ASTM B117 3,000 hour salt spray test to provide protection against corrosion due to acids, solvents, and salt found in the environment.

Electric Heat Coils

The optional 5, 10, 15, or 20 kW electric heat coil shall be factory-installed inside the unit cabinet, be integral to the supply fan housing and be used as boilerless, supplemental, primary, or emergency heat. 15 and 20 kW heaters shall be 2-stage.

Desuperheater

The optional desuperheater (Unit sizes 024 – 070) shall be factory-installed in the compressor compartment and used to add supplemental heating, using superheated refrigerant gas through a tube-in-tube heat exchanger to the domestic hot water supply. Water lines shall be fastened to the exterior panel with flush mounted brass NPT fittings.

- Factory-Installed Option: The desuperheater pump shall be factory-installed inside the unit. (Voltage 208-230/60/1 and 208-230/60/3 only)

Hydronic Heat Option

The factory installed hydronic heating option shall provide control of a factory installed two position valve connected to a hot water coil and shall operate when loop water temperature is warm enough for hydronic heating. Loop water temperature is sensed by a factory installed entering water temperature sensor located on the inlet water line. Hydronic heat circuit shall be independent and substitute the use of the compressor driven refrigeration circuit. Hydronic heating setpoint allowed range is 70°F to 120°F, with a 70°F default value.

Hot Gas Reheat Smart Dehumidification Option

The optional factory-installed hot gas reheat coil shall be used as part of a dehumidification operating sequence. Hot gas reheat shall be enabled when the space humidity level is above a user selectable set point, typically, 50 to 55% RH. Superheated refrigerant gas shall be diverted to the reheat coil and unit fan shall operate at dehumidification fan speed upon a call for dehumidification. This option includes a hot gas reheat coil and a solenoid actuated 3-way valve. Coil shall be proof and leak tested. A corrosion resistant coated hot gas reheat coil shall be available as an option.

Simplified Dehumidification Option

Available as a factory-installed option, unit shall be configured to allow for maximum latent capacity while decreasing room humidity levels by optimizing blower fan speed for dehumidification. Option requires a thermostat with a minimum of 3 cooling stages.

Humidistat Controlled Dehumidification Option

Available as a factory-installed option, unit shall be configured to allow for maximum latent capacity while decreasing room humidity levels by optimizing blower fan speed for dehumidification. Option requires a humidistat as well as a thermostat with a minimum of 2 cooling stages.

Dehumidification Always Option

Available as a factory-installed option, for cooling only applications, this option shall utilize a humidistat only. Upon a call from the humidistat, the unit shall be configured to run at dehumidification blower speed combined with maximum compressor speed, allowing for maximum latent capacity.

Waterside Economizer

A factory mounted and wired waterside economizer shall consist of a hydronic cooling coil located between the unit filter rack and evaporator, a 2-position 3-way diverting valve, a manual air vent, and an entering fluid sensor. The waterside economizer outer cabinet shall be powder-coat painted with standard color textured paint. The cabinet shall be fabricated from heavy gauge G-60 galvanized sheet metal with interior surfaces lined with a minimum 3/8-inch thick closed-cell non-fibrous

IAQ insulation. Components shall be accessible without removing economizer. An insulated stainless steel drain pan compliant with ASHRAE 62.1 including electronic condensate overflow protection shall be provided. Economizer flush mounted piping connections shall be on the same side as the WSHP unit piping connections. Hose kits shall be provided for field connection of economizer to WSHP unit. For corrosive environment applications, a corrosion resistant coated coil shall be available.

The unit mounted control system shall allow economizer operation for either supplemental to mechanical unit cooling or independent, based on entering fluid temperature and refrigerant suction temperature operating conditions. Economizer operation shall be permitted when entering fluid temperature is below 55°F yet adjustable between 70°F to 50°F. Economizer operation shall be initiated from a 3-stage wall mounted thermostat or room temperature sensor. Economizer operation shall not be permitted when entering fluid temperature is below 35°F.

Motorized Water Isolation Valves

The optional 2-way motorized isolation valve shall be factory-installed inside the compressor compartment. The valve actuator shall be factory wired to the Micro-Tech III SmartSource controller and be controlled when there is a call for heating or cooling. The valve shall have an end switch to ensure valve is fully open prior to compressor operation.

External Loop Pump(s)

This option includes the addition of an externally mounted water pump on unit sizes 2 tons and larger. Single pump or dual pumps available. Pumps shall be piped in series. The pump(s) shall be able to produce nominal GPM (3 GPM/ton) and be able to overcome the internal pressure drop of the coax heat exchanger, plus 30 feet additional water pressure drop with 25% PG antifreeze solution.

Disconnect Switch

This factory-installed option shall include the addition of a 3-pole switch mounted on the unit. The switch shall have a lockout/tag out feature. The switch shall be rated to be added to all units to handle the unit only (not to include units with optional factory-mounted electric heat). The switch shall be rated to handle all the voltages available for the unit. (460/3/60 requires 4-wire power service)

Sound Package

Available as a factory installed option, unit sizes 024 – 070 shall utilize sound attenuating compressor blankets combined with high technology sound attenuating material that is strategically applied within the air handling compartment to further reduce sound transmitted by the unit while in operation. Unit sizes 007 – 019 shall have sound attenuating material in the compressor compartment in lieu of a compressor blanket. Compressor sound blanket is not recommended on a unit with a rotary compressor.

Water Pressure Differential Switch

Available as a factory installed option, a water pressure differential switch monitoring the water pressure drop across the heat exchanger shall be factory mounted internal to the cabinet and shall disable compressor operation if flow is not detected.

Coaxial Coil Supply Liquid Auto Flow Regulator

This factory-installed option includes the addition of an automatic flow control valve to set and limit the GPM through the unit. The valve shall have a “replaceable cartridge” capability. The valve shall be rated for 600 psig. (Note: This option will not be available with External Loop Pump option.)

Solid-State Control System

MicroTech III SmartSource Control System - Unit shall have a microprocessor- based control system. The unit control logic shall provide cooling, heating, smart dehumidification, and/or economizer operation as required by the thermostat and/or sensor. The control system shall provide the following for stand-alone operation:

1. The use of standard non-programmable or programmable wall thermostats.
2. Fan operation simultaneous with the compressor (fan interlock) regardless of thermostat logic.
3. Time delay compressor operation.
4. Compressor short cycle protection of a minimum of three minutes before restart is possible.
5. Random unit start-up
6. Single grounded wire connection for activation of the unoccupied or unit shutdown modes.
7. Night setback temperature setpoint input signal from the wall thermostat.
8. Override signal from wall thermostat to override unoccupied mode for 2 hours.
9. Brownout protection to suspend unit operation if the supply voltage drops below 80% of normal.
10. Condensate overflow protection to suspend cooling operation in an event of a full drain pan.
11. Suspended compressor operation upon activation of the refrigerant pressure switch(es).
12. Cooling operation activated for 60 seconds upon activation of the low suction temperature sensor - defrost cycle.
13. Method of defeating compressor, reversing valve and fan time delays for fast service diagnostics.
14. Remote Alarm reset - Provides ability to remotely reset the unit upon a fault condition.
15. Fault Retry clears faults the first two times they occur within a 24-hour period and triggers automatic lock-out on third fault.
16. Control shall be configurable to accommodate thermostat or sensor based control.

Smart Fan Controls

All units shall have the capability of lowering the CFM as the space temperature approaches the thermostat setpoint, through smart fan controls. Smart fan controls shall allow variable airflow control, based on the call for 1st and 2nd stage heating or cooling.

Cooling Mode – On an initial call for cooling, the fan shall be energized at its “fan only” setting. After a 0 to 30 second random delay, the compressor and fan will start at the stage 1 cooling settings. If room setpoint conditions are not satisfied, the compressor and fan will operate at the stage 2 cooling settings. When the room setpoint conditions are satisfied, the compressor will shut off and the fan will operate according to its “fan only” setting, when enabled for continuous fan operation. If fan cycling is enabled, the fan will turn off once room setpoint conditions are satisfied.

Heating Mode – On an initial call for heating, the fan shall energize at its “fan only” setting. After a 0 to 30 second random delay, the reversing valve is energized after 60 seconds, the compressor and fan will start at stage 1 heating settings. If room setpoint conditions are not satisfied, the compressor and fan will operate at stage 2 heating settings. When the room setpoint conditions are satisfied, the compressor will shut off and the fan will operate according to its “fan only” setting, when enabled for continuous fan operation. If fan cycling is enabled, the fan will turn off once room setpoint conditions are satisfied. The reversing valve will be de-energized 60 seconds later.

Smart Dehumidification Mode – (Optional for unit equipped with hot gas reheat) Uses hot gas reheat, a humidistat, a 2-stage thermostat and air flow management for precise humidity control. When the cooling and heating temperature setpoint is satisfied and there is a call for dehumidification, maximum dehumidification is initiated by energizing the fan at its “fan only” setting, energizing the pump request, energizing the 45 second proof-of-flow timer, energizing the hot gas reheat solenoid valve, energizing the compressor at maximum cooling, and energizing the fan at the dehumidification setting. When the room humidity conditions are satisfied, the compressor will shut off and the fan will operate according to its “fan only” setting, when enabled for continuous fan operation. If fan cycling is enabled, the fan will turn off once room humidity conditions are satisfied.

Supplemental Electric Heat Mode – (Optional for unit equipped with supplemental electric heat). On a call for heating, the fan will energize at its “fan only” setting, the pump request will energize, the 45 second flow timer will start. After the flow, compressor minimum off, and random startup timers are expired, the compressor and fan will start at stage 1 heating settings; the reversing valve shall energize 5 seconds after the compressor turns on.

If room setpoint conditions are not satisfied, the fan will operate at stage 2 heating settings. If room setpoint conditions are still not satisfied, the compressor will continue to operate and stage 1 electric heat will be energized and the fan will operate at its electric heat setting. For units equipped with 2 stages of electric heat, if room setpoint conditions are still not satisfied, the second stage of electric heat will be energized and the fan will continue to operate at its electric heat setting. When the room setpoint conditions are satisfied, electric heat will be de-energized allowing the compressor to remain on if necessary to maintain room setpoint conditions. The fan will operate according to its “fan only” setting when enabled, for continuous fan operation. If fan cycling is enabled, the fan will turn off once room setpoint conditions are satisfied.

MicroTech® III Control with LONWORKS Communication Module – Unit shall have a microprocessor-based control system. The unit control logic shall communicate over a LONMARK communications network. The unit controller is factory programmed [LONMARK® 3.4 certified Application Code the current standard for new applications] and tested with all the logic required to monitor and control heating and cooling operation. The controller sets the unit mode of operation, monitors water and air temperatures, and can communicate fault conditions via a LONMARK communications network. Units with the MicroTech III and LONWORKS communication module include return air, discharge air and leaving water temperature sensors. Space temperature sensor options include a set-point adjustment, tenant override button, and the capability of substituting the return air sensor with a wall-mounted room sensor.

MicroTech III SmartSource Control w/ BACnet Communication Module – Unit shall have a microprocessor-based control system. The unit control logic shall communicate over a BACnet communications network. The BACnet communication module shall incorporate an Atmel ARM7 Thumb series MCU and be capable of supporting a full MSTP BACnet implementation. The microprocessor shall also support SPI compatible communications with the MCU of the MicroTech III SmartSource controller. The physical interface to a BACnet BAS network shall be through an industry standard RS-485 transceiver capable of existing on an RS-485 network of up to 64 nodes. The unit controller is factory programmed and tested with all the logic required to monitor and control heating and cooling operation. The controller sets the unit mode of operation, monitors

water and air temperatures, and can communicate fault conditions via a BACnet communications network. Units outfitted with Microtech III and BACnet Communication modules include return air, discharge air and leaving water temperature sensors. Space temperature sensor options include a set-point adjustment, tenant override button, and the capability of substituting the return air sensor with a wall-mounted room temperature sensor.

Each communicating unit controller performs the following unit operations:

- Enable heating and cooling to maintain space temperature set point at the room sensor
- Enable fan and compressor operation
- Monitor all safety controls
- Monitor discharge and return air temperature
- Monitor leaving water temperature
- Relay status of all vital unit functions
- Support optional control outputs

Unit mounted LED annunciators aid in diagnosing unit operation by indicating the water source heat pump operating mode and alarm conditions. If there are no current alarm conditions, a green LED on the annunciator board will indicate occupied unit operating mode. If an alarm condition exists, the MicroTech III SmartSource unit controller will send the fault condition to the LED annunciator, which will assist in troubleshooting the unit. Heat pumps with the MicroTech III SmartSource unit controller with a LONWORKS Communication Module is designed to be linked with a centralized Building Automation System (BAS) through a LONMARK communications network for centralized scheduling and management of multiple heat pumps.

Wall-mounted room sensors are available to control the operation of each MicroTech III Water Source Heat Pump.

Warranty

- An optional 1-year extended compressor warranty covers the compressor for 2 years from the date at which the unit ships from the factory.
- An optional 1-year extended refrigeration circuit warranty covers the entire refrigeration circuit and related components for 2 years
- An optional 1-year extended complete parts warranty covers all parts components for 2 years.
- An optional 4-year extended compressor warranty covers the compressor for 5 years from the date at which the unit ships from the factory.
- An optional 4-year extended refrigeration circuit warranty covers the entire refrigeration circuit and related components for 5 years
- An optional 4-year extended complete parts warranty covers all parts components for 5 years.

In addition to the above warranties an optional 1st year labor allowance is available.

When an extended 4 year complete parts warranty is selected, an optional 5 year labor allowance is available.

Field Installed Accessories

Wall-Mounted Thermostats:

- Programmable Touch Screen Thermostat
 1. Optional Remote Room Sensor
 2. Optional Outdoor Temperature Sensor
- Non-Programmable Thermostat
 1. Optional Remote Room Sensor
- Programmable Thermostat
 1. Optional Remote Room Sensor

Wall Mounted Room Temperature Sensors for BAC-net and LonWorks Communications:

- Digitally Adjustable Wall Sensor with Temperature and Humidity Display
- Adjustable Cool/Warm with Occupancy Switch, Override/Reset Button, Status LED, Fan and System Switch
- Adjustable 55°F to 95°F and 12°C to 33°C, Override/Reset Button, Status LED, Fan and System Switch
- Adjustable -5°F to +5°F and -21°C to -15°C, Override/Reset Button, Status LED, Fan and System Switch
- Basic Sensor, Override/Reset Button, Status LED

Humidistat

To be used in conjunction with one of the dehumidification options. Humidistat to be wall mounted and capable of providing solid state input to unit controls to enable/disable dehumidification features.

Hose Kits

Supply and Return Hose Kits

Two fire-rated flexible hoses with ASTM ratings of Flame Spread 25, Fuel Contribution 25 and Smoke Density 50 for connection to unit and field piping. Hoses shall be covered with stainless steel braiding to prevent damage. The automatic flow hose kit shall include an automatic flow control valve, two ball valves, two flexible hoses, a high flow Y-strainer, and may include a strainer blow-down and various other accessories. The automatic flow control valve shall be factory set to a rated flow, and shall automatically control the flow to within 10% of the rated value over a 40 to 1 differential pressure, operating range (2 to 80 PSID). Operational temperature shall be rated from fluid freezing, to 225°F. The valve body shall be constructed from hot forged brass UNS C37700 per ASTM B-283 latest revision.

Jumper Hose Kit (Used with Waterside Economizer & Hydronic Heat)

The jumper hose kit used with waterside economizer and hydronic heat shall include a single UL-94 VO fire rated hose with 1-inch male JIC x 90 degree male pipe plated steel adapter.

Condensate Hose Kits

- Optional plastic hose including fittings
- Optional fire-rated, braided steel hose including fittings

Valve Options

- Optional 2-way, Normally Open (N.O.) or Normally Closed (N.C.) motorized valves
- Optional 2-way, mechanical ball valve

Replacement Filters

2-inch MERV 8, 4 inch MERV 13, and 2-inch disposable filters shall be available as direct replacement to factory-installed filters.

Electric Heat Coils

An optional 5, 10, 15, or 20 kW field installed duct heater shall be available. These heaters will require a field provided power source. 15 and 20 kW heaters shall be 2-stage.

Appendix-A

Capacity table legend:

Btu/hr = British Thermal Units per Hour
CFM = Airflow Rate, Cubic Feet per Minute
COP = Coefficient of Performance
EAT = Entering Air Temperature
EER = Energy Efficiency Ratio
EWT = Entering Water Temperature
Ft of W.C. = Feet of Water Column
GPM = Gallons per Minute
kW = Kilowatts
LAT = Leaving Air Temperature
PSI = Pounds per Square Inch
THA = Total Heat of Absorption
THR = Total Heat of Rejection
APD = Air Pressure Drop
WPD = Waterside Pressure Drop

◀ [BACK TO Capacity Data Tables beginning on page 30.](#)

Appendix-B

Hydronic coil performance table:

Legend: Capacity is based on 68/59°F entering air.

Air PD is air pressure drop in inches of water column wet coil.

WPD is water side pressure drop in feet of water. Coil pressure drop only.

◀ [BACK TO "Hydronic Coil Performance" on page 61.](#)

Appendix-C

Note: EC motors on 460/60/3 volt units require a 265 volt power supply. Both a hot AND a neutral wire are required to obtain proper fan motor voltage. Therefore, 4-wires with a wye type wiring arrangement is required.



Daikin Applied Training and Development

Now that you have made an investment in modern, efficient Daikin Applied equipment, its care should be a high priority. For training information on all Daikin Applied HVAC products, please visit us at www.DaikinApplied.com and click on Training, or call 540-248-9646 and ask for the Training Department.

Warranty

All Daikin Applied equipment is sold pursuant to its standard terms and conditions of sale, including Limited Product Warranty. Consult your local Daikin Applied representative for warranty details. Refer to Form 933-430285Y. To find your local Daikin Applied representative, go to www.DaikinApplied.com.

Aftermarket Services

To find your local parts office, visit www.DaikinApplied.com or call 800-37PARTS (800-377-2787). To find your local service office, visit www.DaikinApplied.com or call 800-432-1342.

This document contains the most current product information as of this printing. For the most up-to-date product information, please go to www.DaikinApplied.com.

Products manufactured in an ISO Certified Facility.