

# Installation and Maintenance Manual

# IM 837-6

Group: **Controls**

Part Number: **IM 837**

Date: **January 2026**

## MicroTech® II Chiller BACnet® IP/Ethernet Communication Module

ACZ	Air-Cooled Scroll Condensing Unit
AGS	Air-Cooled Global Screw
AGZ	Air-Cooled Global Scroll
HDC	Water-Cooled Dual-Compressor Centrifugal, Heat Recovery
HSC	Water-Cooled Single-Compressor Centrifugal, Heat Recovery
TGZ	Templifier® Water Heater
TSC	Water-Cooled Single-Compressor Centrifugal, Templifier®
WCC	Water-Cooled Centrifugal, Dual Compressor Series Counterflow
WDC	Water-Cooled Centrifugal, Dual-Compressor
WGS	Water-Cooled Global Screw
WGZ	Water-Cooled Global Scroll
WMC	Water-Cooled Centrifugal, Magnetic Bearing
WPV	Water-Cooled Centrifugal, Single-Compressor
WSC	Water-Cooled Centrifugal, Single-Compressor

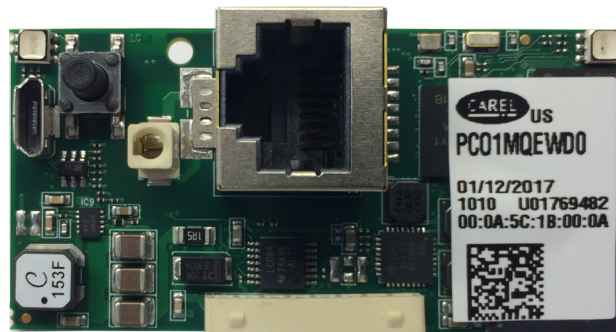

<b>Introduction</b> . . . . .	<b>3</b>	<b>Set up Network Communications</b> . . . . .	<b>11</b>
Revision History . . . . .	3	Set up the Unit for Network Control . . . . .	11
Notice . . . . .	3	Network Setup for Centrifugal Chillers . . . . .	11
Software Revision . . . . .	3	Network Setup for all other Chillers . . . . .	11
Reference Documents . . . . .	3	Configure PC and Communication Module . . . . .	11
Hazardous Information Messages . . . . .	4	Network Considerations . . . . .	11
Features . . . . .	4	BACnet Web Configuration Interface Overview . . . . .	12
Specifications . . . . .	4	Getting Started . . . . .	12
Component Data . . . . .	5	Configure PC and Network Settings . . . . .	13
Current Hardware . . . . .	5	Reset or Restore Communication Module to Factory Defaults . . . . .	13
Light Emitting Diodes (LEDs) . . . . .	5	Test Network Communications . . . . .	14
Status LED . . . . .	6	<b>Network Configuration</b> . . . . .	<b>15</b>
Network LED . . . . .	6	Configure Network Parameters . . . . .	15
BACnet Network Connector . . . . .	6	BACnet Properties . . . . .	15
8-Pin Header . . . . .	6	Clock Setup . . . . .	17
Pushbutton . . . . .	6	System Configuration . . . . .	17
BACnet Web Configuration Interface . . . . .	6	Test Parameters . . . . .	19
Previous Hardware . . . . .	7	Information and Contact . . . . .	20
Light Emitting Diodes (LEDs) . . . . .	7	Configuration via the Unit Controller . . . . .	20
Status LED . . . . .	7	<b>Parts and Service</b> . . . . .	<b>21</b>
Ethernet LED . . . . .	7	Troubleshooting . . . . .	21
BACnet Network Connector . . . . .	7	Parts . . . . .	22
8-Pin Header . . . . .	7	<b>Appendix A: Disabling Internet Services</b> . . . . .	<b>23</b>
Pushbutton . . . . .	7	1. Verify Firmware and Application Software Versions . . . . .	23
BACnet Web Configuration Interface . . . . .	7	2. Upgrade BACnet Communication Module Firmware . . . . .	24
Installation and Mounting . . . . .	8	3. Disable FTP, Telnet, and HTTP Services . . . . .	25
Field Installation Kit . . . . .	8	BACnet Auditing . . . . .	26
Tools Required . . . . .	8	Customer Support . . . . .	26
Installing a new Communication Module . . . . .	8		
Replacing a Communication Module . . . . .	10		

This manual contains information regarding the network integration system used with MicroTech® II unit controllers on Daikin Applied chillers. It describes how to install or replace a BACnet® IP/Ethernet communication module on a MicroTech II chiller unit controller. It also explains how to set network parameters and establish communication between the chiller and BACnet network.

## Revision History

IM 837	Jun 2006	Initial release
IM 837-1	Dec 2010	Updated chiller models on front page. Updated table on p.13 with correct passwords and menu screen information for chiller models.
IM 837-2	Mar 2017	Updated Daikin Applied brand logo and associated references, document part numbers, web configuration tool instructions and screen shots. Major formatting changes. Added specifications, troubleshooting and new figures throughout. Updated PC operating system and browser requirements and setup instructions for BACnet Web Configuration Tool.
IM 837-3	Nov 2017	Added Appendix A: Disabling Internet Services for GSA facilities. Updated Firmware and Software Revision section and related references.
IM 837-4	Apr 2020	Updated to add new BACnet IP hardware.
IM 837-5	Jun 2022	Updated software version and firmware revision. Updated Reference documents. Updated hardware specification.

## Software Revision

This document supports the following BACnet Communication Module software and firmware, and all subsequent versions, until otherwise indicated.

### Current Hardware:

Application Software Version: 2.15.4E

Firmware Revision: AeBCM-2.0.9- BeBCM-2.0.9

### Previous Hardware:

Application Software Version: 2.10

Firmware Revision: AeBCM-12.1 – BeBCM-1.1.5-rc8

OR

Application Software Version: 2.10

Firmware Revision: AeBCM-11.1 – BeBCM-1.1.5-rc7

## Limited Warranty

Consult your local Daikin Applied representative for warranty details. To find your local Daikin Applied representative, go to [www.DaikinApplied.com](http://www.DaikinApplied.com).

## Reference Documents

Company	Number	Title	Source
American Society of Heating, Refrigerating and Air-Conditioning Engineers	ANSI/ASHRAE 135-2004	BACnet- A Data Communication Protocol for Building Automation and Control Networks	<a href="http://www.ashrae.org">www.ashrae.org</a>
Daikin Applied	ED 15100	MicroTech II BACnet IP/ Ethernet Chiller Unit Controller Protocol Document	<a href="http://www.DaikinApplied.com">www.DaikinApplied.com</a>
Daikin Applied	IOM 1210	WMC - Magnetic Bearing Compressor Chiller Installation, Operation, and Maintenance Manual	<a href="http://www.DaikinApplied.com">www.DaikinApplied.com</a>
Daikin Applied	IOM 1274	WSC - Single Centrifugal Compressor Installation, Operation, and Maintenance Manual	<a href="http://www.DaikinApplied.com">www.DaikinApplied.com</a>
Daikin Applied	IOM 1281	WDC/WCC - Dual Centrifugal Compressor Installation, Operation, and Maintenance Manual	<a href="http://www.DaikinApplied.com">www.DaikinApplied.com</a>
Daikin Applied	IOM 1319	Templifier TGZ Heat Recovery Water Heaters Operating Manual	<a href="http://www.DaikinApplied.com">www.DaikinApplied.com</a>
Daikin Applied	IOM 1322	WGZ - Water-Cooled Scroll Chiller Operation and Maintenance Manual	<a href="http://www.DaikinApplied.com">www.DaikinApplied.com</a>
Daikin Applied	IOMM ACZ/AGZ (Legacy)	Air-Cooled Condensing Unit Installation, Operation, and Maintenance Manual	<a href="http://www.DaikinApplied.com">www.DaikinApplied.com</a>
Daikin Applied	IOMM AGZ (Legacy)	Air-Cooled Scroll Chiller Installation, Operation, and Maintenance Manual	<a href="http://www.DaikinApplied.com">www.DaikinApplied.com</a>
Daikin Applied	IOMM WPV (Legacy)	Centrifugal Chiller Installation, Operation, and Maintenance Manual	<a href="http://www.DaikinApplied.com">www.DaikinApplied.com</a>
Daikin Applied	OM 1127 (Legacy)	AGS - Air-Cooled Screw Chiller Operating Manual	<a href="http://www.DaikinApplied.com">www.DaikinApplied.com</a>
Daikin Applied	OM WGS (Legacy)	Water-Cooled Screw Chiller Operating Manual	<a href="http://www.DaikinApplied.com">www.DaikinApplied.com</a>

## Hazardous Information Messages

### Recognize Safety Symbols, Words and Labels

The following symbols and labels are used throughout this manual to indicate immediate or potential hazards. It is the owner and installer's responsibility to read and comply with all safety information and instructions accompanying these symbols. Failure to heed safety information increases the risk of property damage and/or product damage, serious personal injury or death. Improper installation, operation and maintenance can void the warranty.

#### CAUTION

Cautions indicate potentially hazardous situations, which can result in personal injury or equipment damage if not avoided.

Static sensitive components. Can cause equipment damage.

Discharge any static electrical charge by touching the bare metal inside the control panel before performing any service work. Never unplug cables, circuit board terminal blocks, or power plugs while power is applied to the panel

#### WARNING

Warnings indicate potentially hazardous situations, which can result in property damage, severe personal injury, or death if not avoided.

#### DANGER

Dangers indicate a hazardous situation which will result in death or serious injury if not avoided. Electric shock hazard. Can cause personal injury or equipment damage. This equipment must be properly grounded. Connections and service to the MicroTech II Unit Controller must be performed only by personnel knowledgeable in the operation of the equipment being controlled.

#### NOTICE

This equipment generates, uses and can radiate radio frequency energy and, if not installed and used in accordance with this instruction manual, may cause interference to radio communications. It has been tested and found to comply with the limits for a Class A digital device, pursuant to part 15 of the FCC rules. These limits are designed to provide reasonable protection against harmful interference when the equipment is operated in a commercial environment. Operation of this equipment in a residential area is likely to cause harmful interference in which case the user will be required to correct the interference at his or her own expense. Daikin disclaims any liability resulting from any interference or for the correction thereof.

The BACnet communication module connects the MicroTech II chiller unit controller to a building automation system (BAS). This interface enables the exchange of BACnet objects between the unit controller and the network. The BACnet communication module, together with the unit controller, support BACnet Ethernet and BACnet IP (physical layer).

## Features

- Integration into a building automation and control system via BACnet IP or Ethernet
- Simple insertion of the circuit board module into a MicroTech II chiller unit controller
- Several options for setting network parameters via the BACnet Web Configuration Tool user interface, unit controller, or BAS
- LEDs that indicate communication status and network activity
- BACnet application pre-installed and ready for custom configuration

## Specifications

The following section provides a summary of technical data and conformance to agency listings.

General	
Dimensions	2 3/8" x 1 3/16" (60 x 30 mm)
Operating	
Temperature	-40 - 158°F (-40 - 70°C)
Humidity	<90% RH
Storage and Transportation	
Temperature	-40 - 158°F (-40 - 70°C)
Humidity	<90% RH
Electrical	
Power	DC 5 V (+5% / -5%)
Network cable	RJ45 connector, Ethernet 10/100BaseT Cat 5 shielded cable, max 328 ft (100 m)
Network	
Protocols supported	BACnet communication: Ethernet ISO 8802-2 over 8802-3; 10/100 Mbps Full-Duplex (Current Hardware) Ethernet network and BACnet IP (Addenda A/Annex J)
DHCP network functionality	Supports networks with Dynamic Host Configuration Property (DHCP) capability
Software configuration tool	Communication module network addressing via the BACnet Web Configuration Interface browser-based tool
Agency Listings - Unit Controller	
US	UL 873
Canada	CSA C22.2 No. 24-93

**NOTE:** Previous hardware was 10 Mbps, Half-Duplex

## Component Data

The BACnet IP communication module is a printed circuit board that inserts directly into the serial card slot of the MicroTech II chiller unit controller as shown in Figure 1. There have been two versions of the BACnet IP/Ethernet

communication module. The current version (Figure 2) has the Ethernet jack perpendicular to the face of the unit controller. The previous version (Figure 3) has the Ethernet jack parallel to the face of the unit controller.

Figure 1: BACnet IP Communication Module Attached to Unit Controller

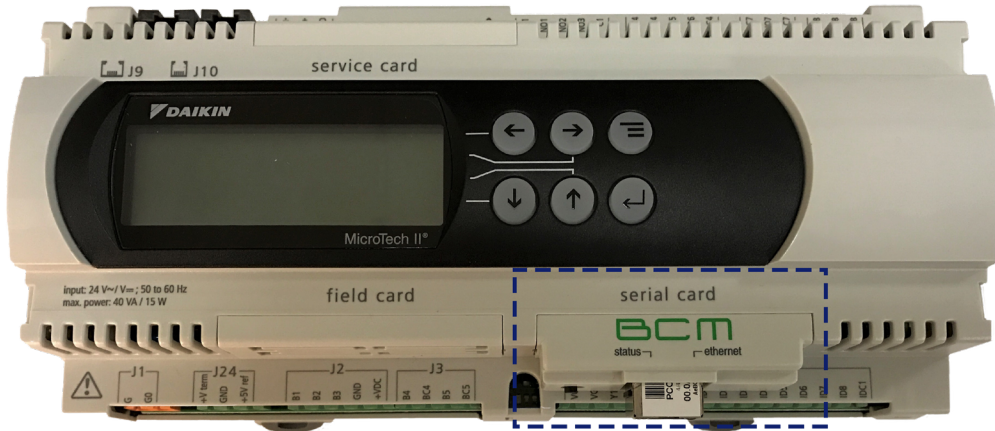

Figure 2: Current BACnet IP/Ethernet Hardware

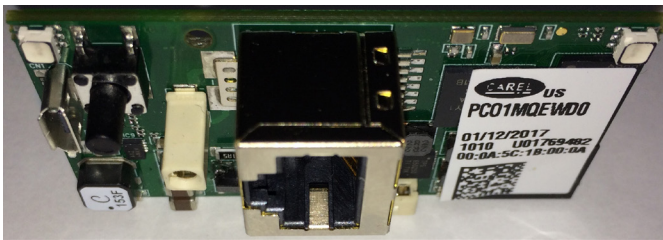
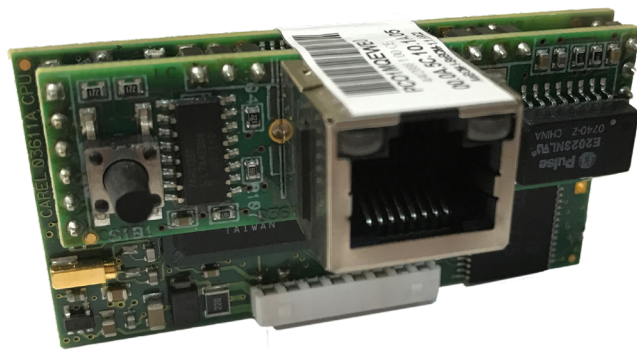

Figure 3: Previous BACnet IP/Ethernet Hardware



## Current Hardware

### Light Emitting Diodes (LEDs)

The communication module has a Status LED and a Network LED to indicate communication activity and status of the module. These indicators are visible when the communication module is connected to the chiller unit controller and the unit is powered on. See Figure 4 for LED locations.

Figure 4: Current Version of BACnet IP/Ethernet Hardware

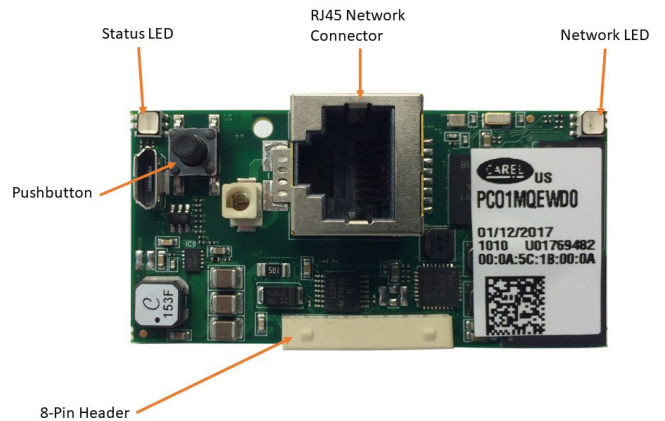



## Status LED

The Status LED indicates the communication state between the communication module and the unit controller. [Table 1](#) describes the activity of the Status LED. During power-up or restart, the Status LED shows the following sequence:

- Immediately after startup: quick flashing red-green
- 2 seconds after startup: solid green with occasional green and red flashes
- 30 seconds after startup: regularly flashing green

Once the startup process is complete, the Status LED consistently flashes green.

**Table 1: Status LED Activity - Current Hardware**

Status LED Color	Description
Quick flashing green	Communication is established between the communication module and the unit controller.
Slow flashing red	Communication has not been established between the communication module and the unit controller.
Green/red flashing	The communication module detects an error or a temporary answer fault from the unit controller.

## Network LED

The Network LED shows the communication status between the communication module and the Ethernet network. The table below describes the status of the Network LED.

**Table 2: Ethernet LED Activity - Current Hardware**

Network LED Color	Description
Solid Green with occasional Green flashes	Communication is established to the network.
Solid Red	Communication is not established to the network. This can be due to several issues, including a cable defect, no power to the unit controller, or the cable is not connected to the network at the other end.

**NOTE:** The color of the Network LED is based only on the electrical connection. The communication module checks for the correct signals from the remote device in the Ethernet cable. There are no parameter settings in the communication module that affect this LED.

## BACnet Network Connector

An RJ-45 plug connector connects the communication module to the Ethernet network ([Figure 4](#)).

## 8-Pin Header

The 8-pin header connects the unit controller to the communication module ([Figure 4](#)).

## Pushbutton

The pushbutton is used to either reboot the communication module or temporarily restore the factory defaults ([Figure 4](#)). Refer to the Reset or Restore Communication Module to Factory Defaults section for detailed information about when and how to use the pushbutton.

## BACnet Web Configuration Interface

The communication module uses a web browser tool to access and set network addressing parameters. This tool is referred to as the BACnet Web Configuration Interface and is described in detail in the Configure Network Parameters section.

## Previous Hardware

### Light Emitting Diodes (LEDs)

The communication module has a Status LED and an Ethernet LED to indicate communication activity and status of the module. These indicators are visible when the communication module is connected to the chiller unit controller and the unit is powered on. See Figure 5 for LED locations.

Figure 5: Previous BACnet IP/Ethernet Hardware

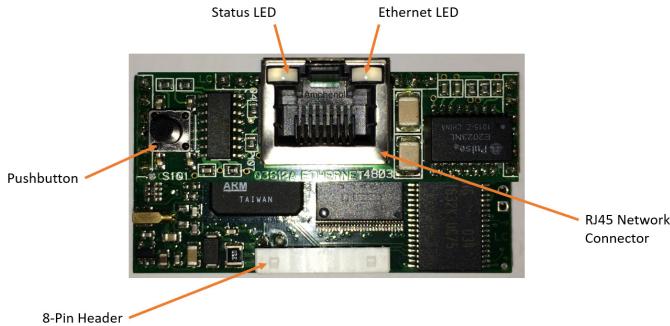

### Status LED

The Status LED indicates the communication state between the communication module and the unit controller. Table 3 describes the color and activity of the Status LED. During power-up, the status LED shows the following sequence.

- Off
- Two seconds after startup: quick flashing red-green
- Five seconds after startup: steady green
- 60 seconds after startup: regularly flashing

Once the startup process is complete, the Status LED blinks at regular intervals. Table 3 below describes the color and activity of the Status LED.

Table 3: Status LED Activity - Previous Hardware

Status LED Color	Description
Quick flashing green	Communication is established between the communication module and the unit controller.
Slow flashing red	Communication has not been established between the communication module and the unit controller.
Green/red flashing	The communication module detects an error or a temporary answer fault from the unit controller.

### Ethernet LED

The Ethernet LED shows the communication status between the communication module and the Ethernet network. Table 4 describes the status of the Ethernet LED.

Table 4: Network LED Activity - Current Hardware

Network LED Color	Description
Red	Communication is not established to the network. This can be due to several issues, including a cable defect, no power to the unit controller, or the cable is not connected to the network at the other end.
Green	Communication is established to the network.

**NOTE:** The color of the Ethernet LED is based only on the electrical connection. The communication module checks for the correct signals from the remote device in the Ethernet cable. There are no parameter settings in the communication module that affect this LED.

### BACnet Network Connector

An RJ-45 plug connector connects the communication module to the Ethernet network (Figure 5).

### 8-Pin Header

The 8-pin header connects the unit controller to the communication module (Figure 5).

### Pushbutton

The pushbutton is used to either reboot the communication module or temporarily restore the factory defaults (Figure 5). Refer to the Reset or Restore Communication Module to Factory Defaults section for detailed information about when and how to use the pushbutton.

### BACnet Web Configuration Interface

The communication module uses a web browser tool to access and set network addressing parameters. This tool is referred to as the BACnet Web Configuration Interface and is described in detail in the Configure Network Parameters section.

## Installation and Mounting

The following section describes how to field install a new BACnet IP communication module or replace an existing module on the chiller unit controller.

**CAUTION**

**Electrostatic discharge hazard. Can cause equipment damage.**

This equipment contains sensitive electronic components that may be damaged by electrostatic discharge from your hands. Before you handle a communication module, you need to touch a grounded object, such as the metal enclosure, in order to discharge the electrostatic potential from your body.

**WARNING**

**Electric shock hazard. Can cause personal injury or equipment damage.**

This equipment must be properly grounded. Only personnel knowledgeable in the operation of the equipment being controlled must perform connections and service to the unit controller.

### Field Installation Kit

The communication module field-installed kit ships with the following items:

**Current Hardware:**

- The BACnet IP/Ethernet communication module circuit board and plastic cover
- This Manual (IM 837)
- An adhesive-backed label printed with two copies of the MAC Address

**Previous Hardware:**

- The BACnet IP/Ethernet communication module circuit board and plastic cover
- This Manual (IM 837)
- An adhesive-backed label printed with two copies of the MAC Address

### Tools Required

- A 3 mm flathead screwdriver

### Installing a new Communication Module

Follow these steps to install a BACnet communication module on the unit controller.

1. Remove power from the unit controller.
2. Locate the serial card slot on the unit controller (Figure 6).
3. Remove the cover from the serial card slot if it has not already been removed. Use a small screwdriver to carefully pry the cover off from one end (Figure 7).

**Figure 6: Serial Card Slot in Unit Controller**

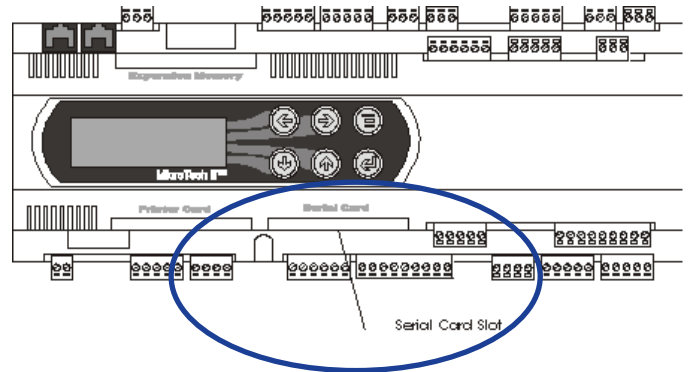

4. Grasp the communication module, with the network connector on the underside. The 8-pin header must mate to the 8-pin plug in the unit controller. The plug has a guide on each end to direct it into the mating guide on the communication module header. Figure 8 shows the serial card slot with the 8-pin plug that mates to the header on the communication module.

**Figure 7: Remove Serial Card Slot Cover**

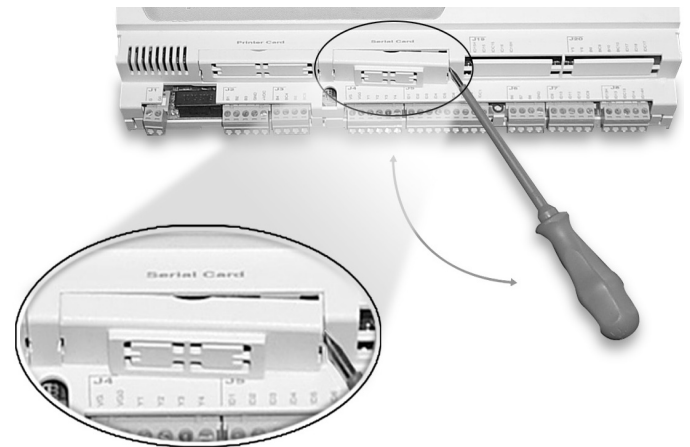
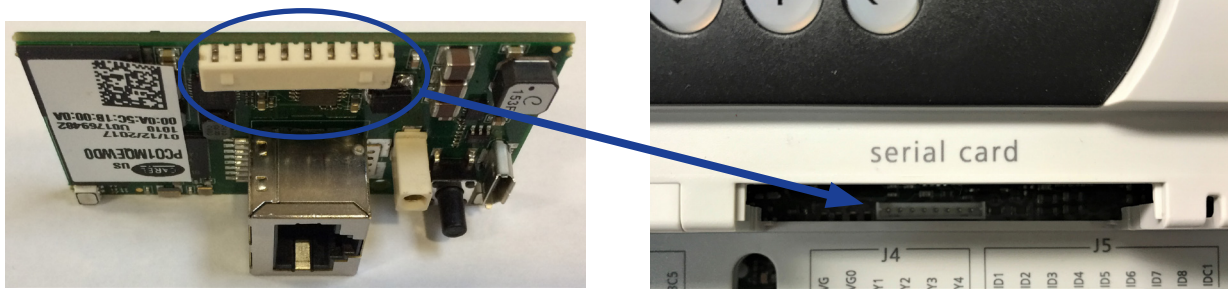



Figure 8: Serial Card Slot Detail



**NOTE:** This operation relies more on fitting the communication module into the connector than seeing the connectors mate.

5. Insert the communication module, pointed up, into the slot. Keeping it *level*, roll the module into position as you guide it into the slot, feeling the connectors line up (Figure 9, Steps 1 and 2).
6. When you feel the connectors align, press the communication module into the plug. Verify that the module is firmly connected (Figure 9, Step 3).

**NOTE:** Previous hardware version is shown below. However, the installation process for current version hardware is identical.

Figure 9: Inserting the Communication Module

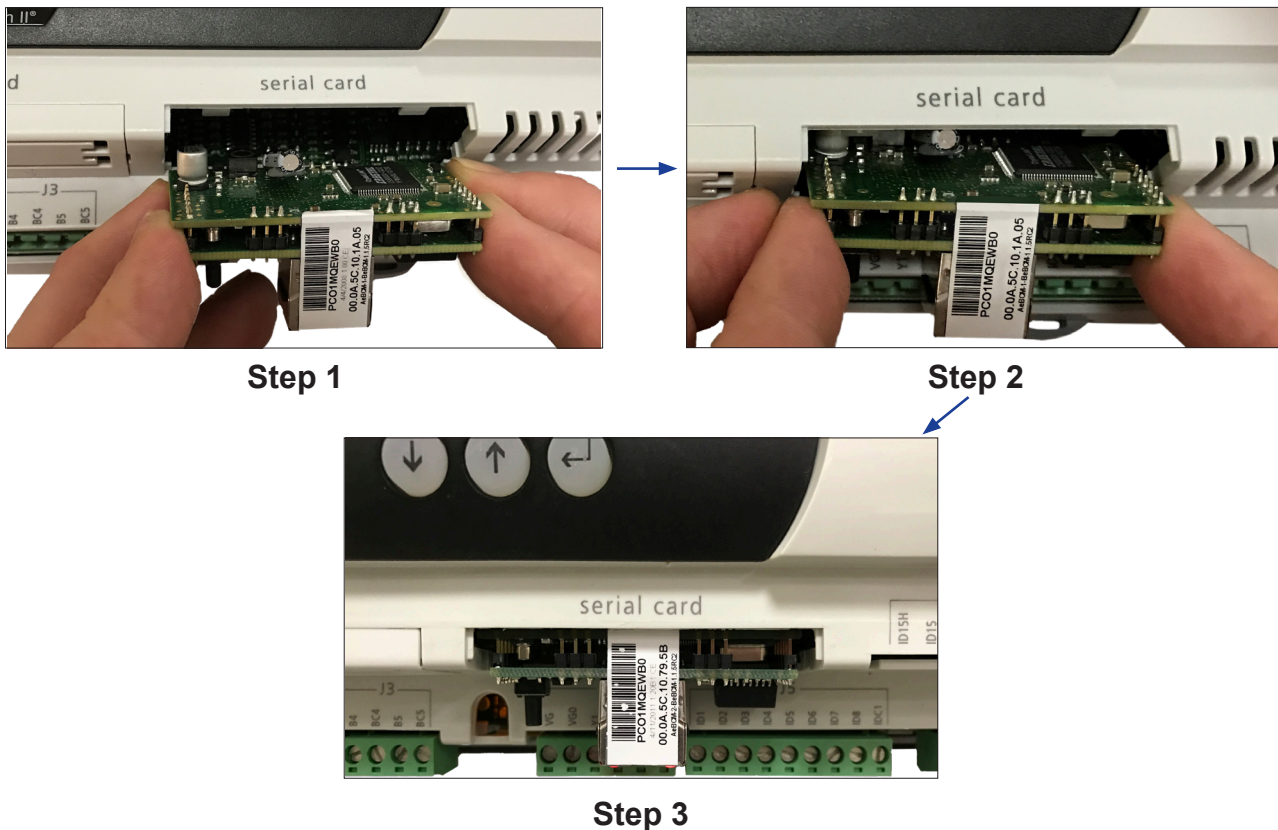

7. Insert the plug-in connector to the communication module.
8. Mount the plastic cover (provided in the field kit) on the serial card slot. Slip the cover over the network connector plug (Figure 10).

Figure 10: BACnet IP Communication Module Cover

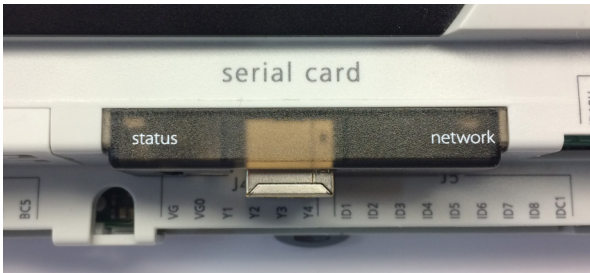

9. During installation, use the scissors to separate the two labels and apply one in an easily accessible position near the unit controller or on the outside of the control panel. This allows for quick reference to the MAC Address at any point after installation.
10. Insert the BACnet network cable connector into the communication module (Figure 11 and Figure 12).

## Replacing a Communication Module

Follow these steps to remove an existing communication module from unit controller and replace it with a new one.

1. Remove power from the unit controller.
2. Locate the serial card slot on the unit controller (Figure 6 on page 8).
3. Pull the network cable connector from the communication module.
4. Remove the cover from the serial card slot. Use a small screwdriver to carefully pry it off from one end (Figure 7 on page 8).
5. Grasp the communication module, with the network connector on the underside. The 8-pin header must mate to the 8-pin plug in the unit controller. The plug has a guide on each end to direct it into the mating guide on the communication module header. Figure 8 on page 9 shows the serial card slot with the 8-pin plug that mates to the header on the communication module.

**NOTE:** This operation relies more on fitting the communication module into the connector than seeing the connectors mate.

6. Insert the communication module, pointed up, into the slot. Keeping it *level*, roll the module into position as you guide it into the slot, feeling the connectors line up.

7. When you feel the connectors align, press the communication module into the connector. Verify that the communication module is firmly connected.
8. Replace the cover on the serial card slot. Slip the cover over the network connector plug (Figure 10).
9. During installation, use the scissors to separate the two labels and apply one in an easily accessible position near the unit controller or on the outside of the control panel. This allows for quick reference to the MAC Address at any point after installation.
10. Insert the network cable connector into the communication module (Figure 11 and Figure 12).

Figure 11: Network Cable Routing and Connections

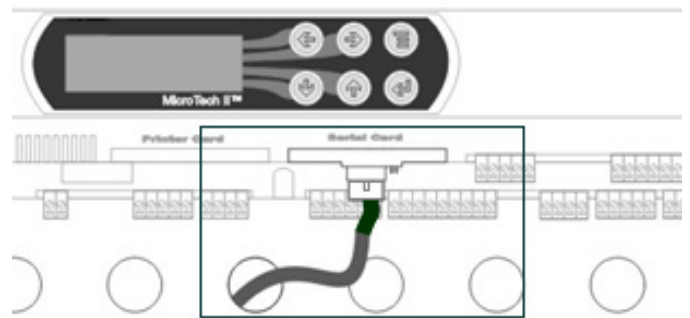
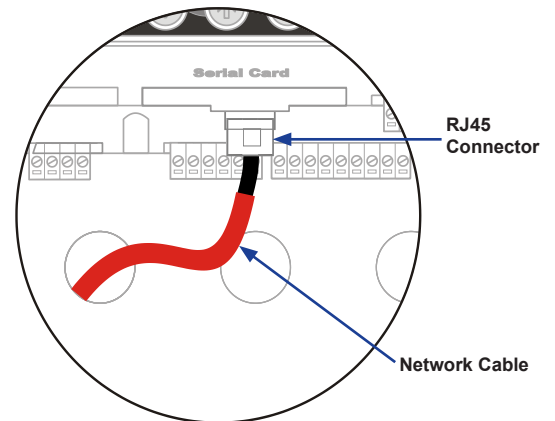

Figure 12: Network Connection Detail



## Set up the Unit for Network Control

After the communication module has been installed, the next step is to configure the unit controller for network control. Follow the instructions below to set the BAS network protocol from the MicroTech II chiller unit controller keypad or touchscreen interface. Once the protocol has been set, the communication module can then be configured for your specific BACnet network requirements.

### Network Setup for Centrifugal Chillers

1. Disable the chiller. The chiller should not be operating while performing this procedure.
2. At the chiller unit controller keypad display:
  - a. Change the Set/Unit Setpoint menu Protocol = to BACnet.

**NOTE:** If using the OITS panel, in the SETPOINTS/MODE screen, set the #9 setpoint = to BACnet.

- b. Enter the password of "2001."
- c. As needed in the Set/Unit Setpoint menu, change Source = to Network.

**NOTE:** If using the OITS panel: as needed in the SETPOINTS/MODE screen, change the #3 setpoint, Control Source = to BAS.

3. Re-enable the chiller.
4. Verify that the chiller is operational from the BAS interface.

### Network Setup for all other Chillers

1. Disable the chiller. The chiller should not be operating while performing this procedure.
2. At the chiller unit controller keypad display:
  - a. Set the Protocol = to BACnet in the applicable menu screen.
  - b. Use [Table 5](#) to determine the operator password for the specific chiller model.
  - c. Enter the password.
3. As needed in the Set/Unit Setpoint menu, change Source = to Network.
3. Re-enable the chiller.
4. Verify that the chiller is operational from the BAS interface.

**Table 5: Password Menu Screen**

Model	Menu Screen	Password
AGZ-A	12	2001
ACZ-A	6	2001
AGZ-B AGZ-C	9	2001
ACZ-B	7	2001
AGS-A AGS-B	12	8945
AGS-C	16	8453
AGS-D	17	8745
WGS	15	8745
WMC WSC WDC WCC WPV HSC HDC TSC	14	2001
WGZ/TGZ	10	2001

**NOTE:** Chiller models AGZ-A/B, ACZ-A/B, WGZ, and TGZ have a single unit controller. Models AGS-B/C and WGS have one unit controller with multiple circuit controllers. Unit settings for AGS-B/C and WGS models are adjusted from the unit controller.

## Configure PC and Communication Module

This section explains how to configure your PC and network settings for use with the communication module's BACnet Web Configuration Interface. It begins with a brief explanation of BACnet networks and IP addressing implications and an overview of the configuration tool, followed by detailed instructions for setting up to use the interface. It also covers how to verify communications and how to reset the communication module IP Address and Subnet Mask.

Refer to the appropriate MicroTech II Chiller Unit Controller IOM for instructions on how to use the unit controller keypad display or OITS menu screens for network setup ([www.DaikinApplied.com](http://www.DaikinApplied.com)).

### Network Considerations

#### Static IP Address

The BACnet IP Address of the MicroTech II chiller unit controller consists of the four-octet IP address followed by the two-octet UDP (User Datagram Protocol) port number. The BACnet/IP address is a six-octet value analogous to a MAC (Media Access Control) address. The IP address portion of the BACnet/IP address must be unique in the BACnet network segment. The default UDP port number of the unit controller is 47808 (BAC0 in hexadecimal).

**Dynamic IP Address - DHCP**

BACnet IP networks with DHCP use a server (typically a router or gateway) to automatically request network configuration parameters, such as IP addresses, to all devices. DHCP-enabled networks eliminate the need for a user to configure these settings manually since IP Addresses and other parameters are determined dynamically by the server.

There are several important aspects to consider with DHCP-enabled networks:

Aspect	Considerations
<b>BBMDs</b>	DHCP <i>can not</i> be used together with BBMDs, as the IP addresses are configured as static addresses and cannot change during operation.
<b>Alarm recipient</b>	In BACnet, alarm recipients are entered with their "Device Object Identifier" or their BACnet address. The IP address is part of the BACnet address and may not be changed for the alarm recipient. For this reason, option "Device Object Identifier" must always be used.
<b>Access rights</b>	If access rights are assigned based on IP address, such as firewalls, the address must be static. Access rights are based off of the UDP Port Number (ex. UDP 47808) or the MAC Address of the communication module.
<b>IP version</b>	The communication module supports IP Version 4, (i.e. IP devices with 32 bit addresses).

The communication module supports DHCP (Dynamic Host Configuration Protocol) IP addressing. By default, this feature is disabled. To configure the communication module to use the DHCP feature, write "DHCP" as the IP address. In a DHCP-based network, the communication module automatically receives the required parameters from the DHCP server. Consult with your network administrator for the information on your network settings.

**Multiple IP Subnets - BBMD**

A BACnet/IP network may consist of multiple IP subnets assigned the same BACnet network number. In this case, a BBMD (BACnet Broadcast Management Device) allows broadcasts to be transmitted to all other BBMDs on the BACnet network. BBMDs allow devices on one network to distribute broadcasts, or communicate, across multiple subnets. A BBMD also provides for foreign device registration. This allows a device on one network to communicate with a device on another network by using the BBMD to forward and route the messages.

The communication module can be registered as a foreign device with a BBMD device. This is done by providing the module with the IP Address and Foreign Device Time-To-Live setting of the BBMD. Once entered, the module automatically registers with the BBMD at the IP Address specified within the Foreign Device Time-To-Live setting. See [Figure 14](#) for BBMD settings available on the BACnet Web Configuration Properties page.

**BACnet over Ethernet Addressing**

The Ethernet MAC address of the communication module is a six-octet address assigned when it was manufactured. It is fixed and cannot be changed. Use this address to access the chiller unit controller on a BACnet Ethernet network.

**BACnet Web Configuration Interface Overview**

The communication module uses the BACnet Web Configuration Interface, a browser-based tool, to configure BACnet settings. The interface is organized by HTTP pages located within a series of tabs. Each HTTP page displays network properties, BACnet addressing parameters, and system configuration options. Specifically, the interface can be used to do the following:

- Adjust network settings such as IP Address and Device Instance Number (particularly with multiple chillers on a single network.)
- Configure parameters
- Test and verify communication with the chiller unit controller
- Establish user(s) and password access
- Set BACnet Alarm notification and communication module clock
- Upgrade communication module firmware
- View all variables mapped to the unit controller

[Figure 14](#) shows the main page of the user interface. This is a read-only screen with a number of setup parameters. The parameters that require setting depend on the data link layer (IP or Ethernet) of the BAS network. The items that appear on the page are relative to the selected BACnet layer. Device, Date/Time, and Alarms require settings for all BACnet networks. BACnet via Ethernet may not require network settings. However, BACnet IP does require network settings. Note that the example shown in [Figure 14](#) is for BACnet IP.

[Table 6](#) lists the primary network parameter settings and Device Object properties supported by the unit controller that are available via the BACnet Web Configuration Interface.

**NOTE:** The Device Instance, BACnet IP Address, IP Subnet Mask, UDP Port, and IP Router Address can only be set using the BACnet Web Configuration Interface.

**Getting Started**

**Required Tools**

- PC with Ethernet interface and TCP/IP protocol capability
- Standard web browser such as Internet Explorer™
- Ethernet cable (either an Ethernet crossover cable for direct connection or a standard Ethernet cable for connecting through a hub).



## Procedure

The steps described in the following section explain how to:

- Configure your PC and network settings to enable access to the BACnet Web Configuration Interface
- Use the BACnet Web Configuration Interface to modify parameters
- Change the network setting options of your PC and web browser options back to the way they were before the configuration process

## Configure PC and Network Settings

**NOTE:** The procedure for changing the network settings varies depending upon your PC's operating system.

To configure your PC for access the BACnet Web Configuration Interface HTTP pages

1. Verify that a standard Ethernet (or crossover cable, for older PCs) is attached to both the Ethernet port on your PC and the communication module.
2. Apply power to the unit controller.
3. Verify Status and Ethernet LED activity is normal (see [Light Emitting Diodes \(LEDs\)](#) section for details).
4. Open a web browser, such as Internet Explorer.
5. Request the network IP Address and Subnet Mask of the communication module from the network administrator.

**NOTE:** The communication module is assigned a temporary IP Address and IP Subnet Mask when shipped. Use these addresses to access the communication module and then make changes to network parameters. In order to access the BACnet Web Configuration Interface, your PC *must* be on the same subnet as the communication module.

### Change the Network Settings

Configure the network settings on your PC to access the communication module. If necessary, refer to the PC's operating system Help function for more information about configuring the IP and Subnet Address.

1. Open the Windows Control panel.
2. Open the Network Connections window.
3. Right click on Local Area Network and Select Properties.
4. Select Internet Protocol (TCP/IP). For Windows 7 and later, select (TCP/IPv4).
5. Select the Properties button.
6. Note the IP Address and Subnet Mask if they have values or that "Obtain IP address automatically" is selected.
7. Select "Use the following IP Address."
8. Change the Subnet mask to 255.255.0.0.
9. Change the IP address to 172.16.X.X (where X.X is unique on the subnet but not 172.16.5.8).
10. Click the OK button.

11. If prompted, reboot your PC to change the Subnet Mask and IP Address.
12. Open the Windows Control Panel (from the Start menu) and select Internet Options/Connections/LAN Settings.
  - a. Note the selections for future reference.
  - b. Verify that Automatically Detect Settings, Use Automatic Configuration Script, and Use a Proxy Server for Your LAN are not selected.

**NOTE:** If these settings are not disabled, the changes you make to the communication with the browser do not take effect.

13. Open your web browser.
14. Type `http://172.16.5.8/` in the Address box of the browser and press the Enter key to access the communication module.
15. Make changes to the communication module's network parameters (see [Configure Network Parameters](#) section).
16. Change the communication module settings by pressing the Save Changes button followed by the Reboot button.
17. Navigate to the web browser's Tools/Internet Options/Connections/LAN Settings.
18. Restore the settings as noted in Step 12a.
19. Restore the network settings on your PC.

## Reset or Restore Communication Module to Factory Defaults

If the IP Address is lost or forgotten, the communication module can be reset to the default IP Address and Subnet Mask.

### Reset the IP Address and Subnet Mask when the Chiller is Off:

1. Unplug network connections from the communication module.
2. Press and hold down the pushbutton for at least 20 seconds.
3. Apply power to the unit controller.
4. Keep the pushbutton pressed for at least 20 seconds.
5. Release the pushbutton once the Status LEDs start to blink red.
6. After three slow red blinks, the LEDs turn green and then rapidly blink dark red three times to indicate the command has been successful.
7. Modify your PC settings to be on the same subnet as the communication module.
8. Log on to the default IP address (172.16.5.8) and modify network settings as necessary.



### **Reset the IP Address and Subnet Mask when the Chiller is On:**

1. Unplug network connections from the communication module.
2. Press the pushbutton for more than five seconds and no more than ten seconds.
3. Release the pushbutton.
4. After another 5 seconds, press and hold the pushbutton again.
5. The Status LED stops flashing and then flashes red quickly.
6. Release the pushbutton when the Status LED starts flashing red slowly.
7. After three slow red blinks, the LED becomes green, and then to indicate the command has been successful, it rapidly blinks dark red three times.
8. Modify your PC settings to be on the same subnet as the communication module.
9. Log on to the default IP Address (172.16.5.8) and modify network settings as necessary.

After successfully using the pushbutton, the communication module only retains the default parameters until the next reboot is performed. It implements the latest user-specified parameters after a reboot has been performed without the pushbutton being pressed.

### **Test Network Communications**

Follow these steps to confirm that your PC is correctly addressed to allow the exchange of information between the unit controller and communication module:

1. Open a DOS window (go to Start button\Programs\Accessories\Command Prompt.)
2. Type "ping 172.16.5.8" at the DOS prompt.
3. Press Enter.
4. Observe response. See [Figure 13](#) for a typical successful response.

**Figure 13: Ping and Response**

```
C:\>ping 172.16.5.8

Pinging 172.16.5.8 with 32 bytes of data:

Reply from 172.16.5.8: bytes=32 time=93ms TTL=63
Reply from 172.16.5.8: bytes=32 time=5ms TTL=63
Reply from 172.16.5.8: bytes=32 time=70ms TTL=63
Reply from 172.16.5.8: bytes=32 time=16ms TTL=63

Ping statistics for 172.16.5.8:
    Packets: Sent = 4, Received = 4, Lost = 0 (0% loss),
    Approximate round trip times in milli-seconds:
        Minimum = 5ms, Maximum = 93ms, Average = 46ms

C:\>
```

## Configure Network Parameters

Once your PC and web browser have been configured and tested, it is then possible to begin using the BACnet Web Configuration Interface to set BACnet parameters and other network options.

**NOTE:** Refer to [Appendix A: Disabling Internet Services](#) if your site must comply with GSA requirements or it requires HTTP, FTP, and Telnet options to be disabled for security purposes.

To use the tool:

1. Connect the communication module via the Ethernet port.
    - a. Open Internet Explorer or other browser and Type <http://172.16.5.8/> in the Address box of the browser.
    - b. Press Enter to access the communication module.
  2. Click the Go to Configure/Test link at the bottom of the BACnet Web Configuration Interface home page.
  3. Enter the User Name “admin” and Password “fadmin.” Note that these are the defaults and can be changed.
  4. Press OK.
  5. Adjust the parameters for your particular network ([Figure 14](#)). It may be necessary to navigate to other pages to find the information you need. For example, the IP Address can be changed on the System/Network page.
  6. Select the Submit button to set the changes into the communication module.
- NOTE:** Changes do not take effect until the module has been rebooted.
7. Press the Reboot button after changes have been saved.
  8. Wait two minutes and allow the communication module to complete the reboot. Then navigate to the screen where you made changes.
  9. Verify that the changes were made. You may need to refresh the screen by pressing the web browser’s Refresh button or by navigating to View/Refresh at the top of the page. If the changes are not made, verify that the LAN Settings are not selected in the browser.
  10. Close the browser.
  11. Remove the connection to the Ethernet port.

## BACnet Properties

[Table 6](#) lists the primary network parameter settings and Device Object properties supported by the unit controller that are available via the BACnet Web Configuration Interface’s BACnet Properties page.

**NOTE:** The Device Instance, BACnet IP Address, IP Subnet Mask, UDP Port, and IP Router Address must be set during the communication module configuration process. The BACnet Web Configuration Interface must be used for these parameters.

1. Change the items on this page as needed and press the Save Changes button.
2. If the changes are correct, press the Reboot System button for the changes take effect ([Figure 15](#)).

**Figure 14: BACnet Web Configuration Properties Page**

**Table 6: BACnet Configuration Properties**

Property/Parameter	Value (Range)/Description	Default Value/Notes	
<b>Device</b>	BACnet LAN Type	BACnet IP or BACnet Ethernet/Indicates the Data Link and Physical layers of the BAS network.	BACnet IP
	BACnet IP/UDP (User Datagram Protocol) Port	Identifies the application process in the communication module.	47808 (Decimal) BAC0 (Hex)
	Device Instance	0-4194303/Device Instance of the communication module.	3000/This must be unique throughout the entire BACnet network.
	Description	This property describes the application running in the communication module.	
	Location	This changeable property indicates the physical location of the chiller.	
	APDU Timeout	The amount of time, in milliseconds, between retransmissions of an APDU requiring acknowledgment for which no acknowledgment has been received.	3000 Milliseconds
	Number of APDU Retries	The maximum number of times that an APDU can be retransmitted.	Three times
	Password for Restart	Password that allows the communication module to be reinitialized from the network.	1234/Blank. Indicates that no password is required. If a password is entered, a password is then required before a BACnet client can re-initialize the communication module.
	Metric Units	Yes or No/ Selecting Yes converts the Units and Relinquish Default properties to Metric units. Selecting No converts these properties to English units.	No/Changing this property does not affect the Present Value property read from the chiller. For centrifugal chillers, the units can be changed via the keypad.
<b>Network Addressing</b>	IP Address	IP Address of the communication module.	172.16.5.8
	Subnet Mask	Subnet Mask of the communication module.	255.255.0.0
<b>Alarms</b>	Alarming Enabled	Yes or No/Enabling this feature provides alarm annunciation from the communication Module to a BACnet client. BACnet clients can also poll variables in a communication module for alarm information.	No/Selecting Yes enables the communication module to send a ConfirmedEventNotification message to a single BACnet device whenever an alarm occurs in the MicroTech II Chiller. This message has an Event Type = Complex Event and has proprietary properties in its Event Values section. Not all BACnet devices can accept this message.
	Alarm Destination Device Instance	0-4194303/Device Object of the BACnet device that receives the alarm notification.	1
	Alarm Process ID	The process used by the receiving BACnet device to determine the response action to the alarm notification.	1/May be changed to suit the BAS preference.
	Alarm Priority	Priority for Problem Alarms (0-255)	0/The lower the priority value, the higher the actual alarm priority.
	Alarm Fault Priority	Priority for Fault Alarms (0-255)	0/The lower the priority value, the higher the actual alarm priority.
	Alarm Warning Priority	Priority for Warning Alarms (0-255)	255/The lower the priority value, the higher the actual alarm priority.
<b>Clock Parameters</b>	Daylight Saving Time	Yes or No	No/Must be set to No for the communication module to synchronize the time on the network. Setting clock parameters is only necessary when the BAS network does not have a Time Master controller on the network. <i>The clock must be reset any time power is lost to the chiller or if the communication module is rebooted.</i>
	UCT Offset	Difference in minutes of the Universal Coordinated Time and local time ( -720 to + 720).	0 Minutes
	Interval to send Whols	The maximum frequency, in minutes, at which the communication module sends Whols Requests.	1 Minute
<b>BBMD Parameters</b>	IP Address for BBMD	IP Address for the BACnet Broadcast Management Device (BBMD) if used.	None
	Time-To-Live for Foreign Device Registration	The time, in seconds, within which the foreign device must re-register with the BBMD. If it does not re-register, the BBMD removes it from its Foreign Device Table (FDT) and discontinues forwarding messages to the foreign device.	0 Seconds

Figure 15: Verify Changes and Reboot System

**Device Properties**

BACnet LAN Type: BIP  
 BACnetIP UDP Port: BAC0 hexadecimal  
 BCM Device Instance: 30077  
 Description: McQuay Chiller - IT Rev 1.7  
 Location: Unknown  
 APDU Timeout: 5000 milliseconds  
 Number of APDU Retries: 3  
 Password for Restart: 1234  
 Metric Units: No

**Alarm Parameters**

Alarming Enabled: No  
 Alarm Destination Device Instance: 0  
 Alarm Process Id: 0

**Clock Parameters**

Daylight Saving Time: No  
 UTC offset: 0 minutes  
 Interval to send WhoIs: 1 minutes (0=none)

**BBMD Parameters**

IP Address for BBMD: None  
 Foreign Device Time-To-Live: 0 seconds

### Clock Setup

Use the Clock Setup page to change settings as required for your network (Figure 16). Table 7 defines the communication module’s clock parameters. The clock is non-volatile, so if the clock is used, the Date and Time must be reset every time power is cycled to the unit controller or when the communication module is rebooted.

Question marks (“??”) in any field represent an invalid value. If question marks appear, refresh the page, enter a valid date and time, and press the Set Clock button to reset the clock parameters.

Figure 16: Clock Setup Tab

**Clock Parameters**

Current Local Time: 1970-01-01 04:59:48  
 Year:  Month:  Day:   
 Last Local Date/Time Configured: Hour:  Minute:  Second:   
 (?? indicates invalid value)

Table 7: Clock Parameters

Field	Parameter	Value (Range)/Description	Default Value
Local Date/Time	Year	Current Year	4-digit year
	Month	Current Month (1-12)	
	Day	Current Day (0-X, where X is the number of days in the month)	
	Hour	Current Hour (0-23)	
	Minute	Current Minute (0-59)	
	Second	Current Second (0-59)	

### System Configuration

The communication module System Configuration information appears under the General, Network, Communications, Users, and Firmware tabs (Figure 17). The following section describes each tab. Change parameters as required for your network.

#### General Tab

This page is used only to view system information. The information includes used/free disk space, factory bootswitch (default) parameters, network configuration, and environment variables.

Figure 17: System Configuration - General Tab

General | Network | Communications | Users | Firmware

**System Information**

- View used/free disk space
- View factory bootswitch parameters
- View network configuration

Copyright © 2015-2017 Daikin Applied

#### Network Tab

Use the network tab to change the IP Address and IP Subnet Mask along with other parameters. See Figure 18 and Table 8 for details.

Figure 18: System Configuration - Network Tab

General | **Network** | Communications | Users | Firmware

**IP Addresses and Subnet Masks**

**Eth0**  
 IP Address Main:  DHCP or empty to set DHCP  
 Netmask Main:

**Eth0:1**  
 IP Alias 1:   
 Netmask 1:

**Eth0:2**  
 IP Alias 2:   
 Netmask 2:

**Eth0:3**  
 IP Alias 3:   
 Netmask 3:

**Gateway**  
 Gateway Address:

**DNS servers**  
 Primary DNS:   
 Secondary DNS:

**Facility Type**  
 GSA Facility (Yes/No):  (default No)

**Internet Services**

**Table 8: Network Parameters**

Field	Parameter	Description	Default Value
Networking Configuration	IP Address Main	IP Address of the communication module	172.16.5.8
	Subnet Mask Main	Subnet Mask of the communication module	255.255.0.0
	IP Alias 1	A second IP address (alias) that the communication module recognizes as it's own	
	Subnet Mask 1	Subnet Mask for IP Alias 1	
	IP Alias 2	A third IP address (alias) that the communication module recognizes as it's own	
	Subnet Mask 2	Subnet Mask for IP Alias 2	
	IP Alias 3	A fourth IP address (alias) that the communication module recognizes as it's own	
	Subnet Mask 3	Subnet Mask for IP Alias 3	
Gateway Configuration	Gateway Address		
Name Resolution	DNS Server 1		
	DNS Server 2		
Facility Type <sup>1</sup>	GSA (US General Services Administration) Facility	Indicates whether or not the facility must comply with GSA security requirements; adds the GSA-required disclaimer to the home page of the Web Configuration Interface	No
Internet Services <sup>1</sup>	HTTP Service	Enabled or disabled	Enabled
	FTP Service	Enabled or disabled	Enabled
	Telnet Service	Enabled or disabled	Enabled

1. Facilities that must meet GSA compliance require an additional verification and configuration process. See [Appendix A: Disabling Internet Services](#) for details.

**Communications Tab**

Use the Communication tab to set the Baud Rate between the communication module and the unit controller. The default value is 19200 bps. Options for the other data transmission rates (300, 600, 1200, 2400, 4800, 9600, 38400, 57600, and 115200 bps) are provided in the drop-down box shown in [Figure 19](#).

**Figure 19: Communications Tab**

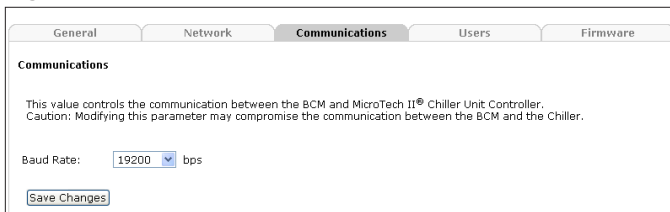

**Users Tab**

Use the Users tab to set the name and password required for accessing the BACnet Web Configuration Interface's HTTP menus. See [Figure 20 - Figure 22](#).

**Change User Name and Password**

1. In the System/Users tab, click on Change Web Page Password ([Figure 20](#)).

**Figure 20: System Configuration - Users Tab**



2. Then click on BCM Main ([Figure 21](#)).
3. Enter a new Username and Password.
4. Press Save Changes.
5. Close the Password Modification Result window.
6. Reboot the communication module by clicking the Reboot button on the left side of the screen.
7. Record the new Username and Password.
8. Use the new User Name and Password whenever you press the Go to Configure/Test link at the bottom of the home page.

**Figure 21: Users Tab - Select Password**



**Reset Lost User Name or Password**

If the User Name or Password are lost or forgotten, the communication module can be temporarily set back to factory bootswitch (default) parameters:

- IP Address = 172.16.5.8
- Subnet Mask = 255.255.0.0
- User Name = admin
- Password = fadmin

These factory default parameters remain valid until the communication module or unit controller is rebooted.

1. Set the unit to the factory bootswitch parameters as shown above.
2. Change the network setting on your PC to the same Subnet Mask as the communication module (see [Configure PC and Network Settings](#)).
3. Log onto the communication module at the default IP Address (172.16.5.8).
4. Change the User Name and Password from the Users tab as explained in the previous section ([Figure 22](#)).



Figure 22: Users Tab - Change User Name or Password

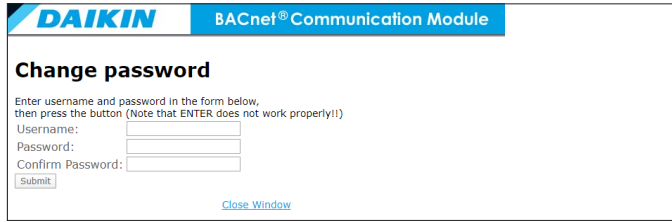

5. Reboot the communication module by pressing the Reboot button.
6. Change your PC settings back (see [Configure PC and Network Settings](#)). All network parameters are now restored.

### Firmware Tab

Use the Firmware page to upgrade the Flash\_sys.bin and Flash\_apps.bin firmware files to the communication module (Figure 23).

The Flash\_sys.bin contains the operating system software. This file does not change frequently and likely does not need to be downloaded. The second firmware file is Flash\_apps.bin. This file contains the application software, including the BACnet management (communication module) software, the HTML screens, and software used to manage chiller communication. If an update is required or recommended, this file requires downloading. If you have any questions regarding the firmware, please contact Daikin Applied Chiller Technical Response Center at 800-432-1342 or chltechsupport@daikinapplied.com.



Figure 23: System Configuration - Firmware Tab

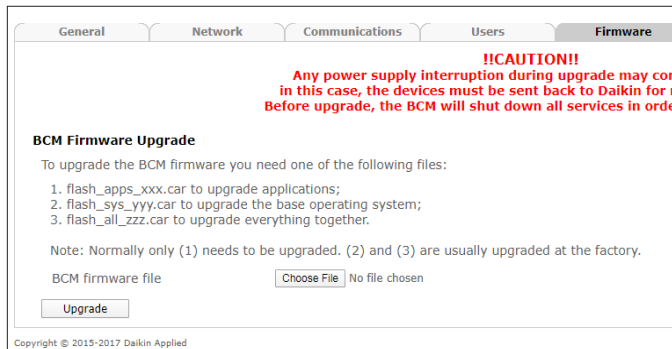

### Test Parameters

Tests Parameters consists of two pages: Test and Variables. Use these pages to read/write variables to the chiller or to ping a remote device on the network. Each page is defined below.

### Test Tab

From the Test page (Figure 24), click on Ping a Remote Host to open another window to enter the IP Address of the device you want to ping. Press Ping to complete the function. This is similar to typing ping followed by the IP address in DOS to locate a device on the network. Figure 25 indicates a successful ping while Figure 26 indicates an unsuccessful ping.

Figure 24: System Configuration - Test Tab

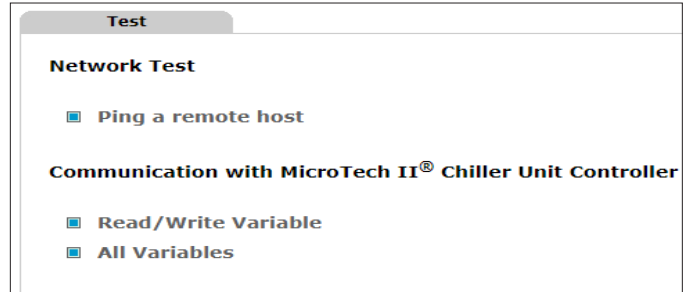

Figure 25: Ping a Remote Host - Successful

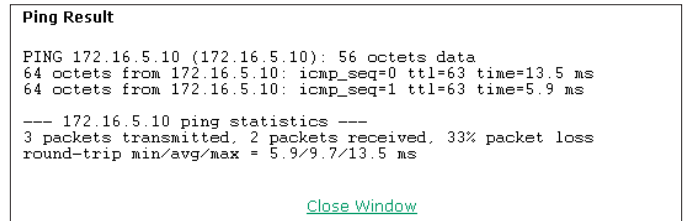
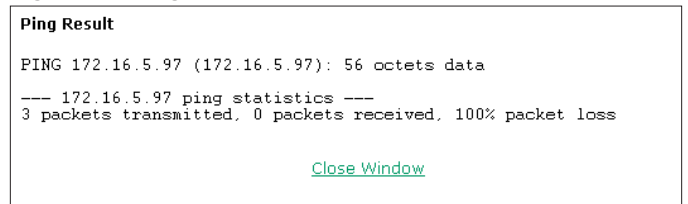

Figure 26: Ping a Remote Host - Unsuccessful



### Read/Write

Use the Read/Write functionality in the Test page to read or write a specific variable (Figure 27). The communication module uses variables of type Analog, Integer, or Digital. The following section defines how to perform a Read and Write. Refer to Protocol Information Document, ED 15100 for additional information ([www.DaikinApplied.com](http://www.DaikinApplied.com)).

To perform a Read:

1. Go to the Tests/Test page.
2. Select the Read/Write link.
3. Select the Variable Number.
4. Select the Variable Type (Digital, Analog, or Integer).
5. Press the Read button.

To perform a Write:

1. Go to the Tests/Test page.
2. Select the Read/Write link.
3. Select the Variable Number.
4. Select the Variable Type (Digital, Analog, or Integer).
5. Press the Read button.
6. In the New Value box, type the value you want to write. See Protocol Information Document, ED 15100 for valid ranges.
7. Press the Write button.

Figure 27: Test Tab - Read/Write

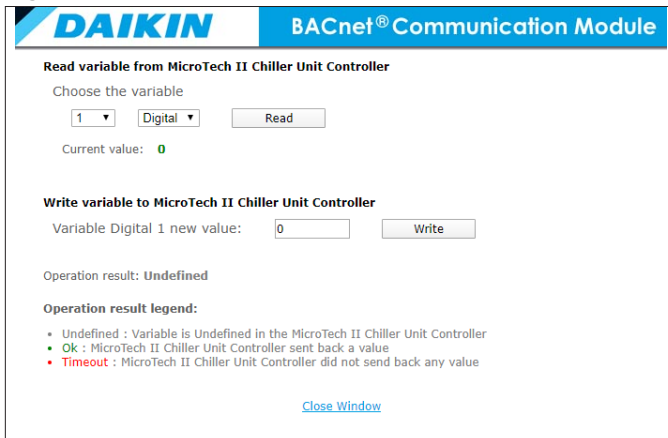

### All Variables

Use the All Variables functionality of the Test page to view the status of BACnet objects that are mapped from the chiller unit controller (Figure 28). The only types supported by the communication module are Analog, Integer and Digital. Refer to Protocol Information Document, ED 15100 for details on how the points are mapped.

Figure 28: All Variables

The screenshot shows a 'Summary Page' with a table of BACnet variables. The table is organized into three sections: 'Digital Variables', 'Analog Variables', and 'Integer Variables'. Each section has a 'Year Life' column and a 'Value' column. The table contains numerous rows of data for each category. A legend at the bottom left indicates the status of the variables: 'Undefined', 'Ok', and 'Timeout'.

### Information and Contact

The Info & Contact page provides general contact information for the Daikin Applied Controls Customer Support Group. It also contains a link to Daikin Applied's public website (Figure 29).

Figure 29: Info & Contact Tab

#### Daikin Applied Controls Customer Support

Toll Free: 1-866-462-7829  
 Direct: 1-763-553-5164  
 Contact: [DaikinControls@daikinapplied.com](mailto:DaikinControls@daikinapplied.com)  
 Product Literature & Integration Information: [www.daikinapplied.com](http://www.daikinapplied.com)

**NOTE:** Effective 1/1/2024 customers should contact Daikin Applied Chiller Technical Response Center at 800-432-1342 or [chltechsupport@daikinapplied.com](mailto:chltechsupport@daikinapplied.com) for support.

### Configuration via the Unit Controller

If you wish to change default parameter values from the unit controller keypad display or OITS panel, see the appropriate Operation Manual for network menu items and keypad operating instructions. Use the MicroTech II Chiller Unit Controller Protocol Information Document, ED 15100 for BACnet object descriptions ([www.DaikinApplied.com](http://www.DaikinApplied.com)).

**NOTE:** The Device Instance, BACnet IP Address, IP Subnet Mask, UDP Port, and IP Router Address **must** be set using the BACnet Web Configuration Interface. They cannot be modified via the unit controller keypad/display.

## Troubleshooting

Follow these procedures if you can control the chiller unit controller from its keypad/display or touchscreen interface, but you are not able to communicate with the unit via the network.

### Network Parameters

- Verify that network parameters are set correctly as shown in [Table 6](#).
- Make sure there are no duplicate devices on the network (Device Name and Device ID, for example).

### Network wiring

- Check for loose connections and that devices are plugged in properly.
- Confirm that the link light for each device's connector is on, which indicates that information is capable of being sent and received.

### Compatibility

- Verify the unit controller software application version and the communication module's Flash\_sys.bin and Flash\_apps.bin firmware files.

### Network Communications

- Confirm that the DHCP parameter is set to "Off" when a static IP address is being used for non-DHCP networks.
- Check that the defined UDP port, e.g. BAC0, is open in the firewall.
- Verify if BBMDs are required. BBMD must be used if the BACnet client and BACnet server are located on different subnets. Use the command "tracert" to check this. Tracert shows all stations used to forward the signal to another segment. See [Figure 30](#) for the result of a BBMD network as displayed by using the "tracert" command.

Figure 30: Example of Confirmed BBMD Network

```

C:\WINNT\system32\cmd.exe
Microsoft Windows XP [Version 5.1.2600]
(C) Copyright 1985-2001 Microsoft Corp.
C:\Documents and Settings\scheunea\Desktop>tracert 10.169.8.193
Tracing route to 10.169.8.193 over a maximum of 30 hops
  0  <1 ms    <1 ms    <1 ms   139.16.79.252
  1  <1 ms    <1 ms    <1 ms   10.169.8.193
Trace complete.
    
```

→ Use the standard TCP/IP suite of tools to check connectivity with other devices. Ping the unit controller using these steps if the communication module is not working:

Step	Action
1	Select Start > Run on the Windows start bar → The "Run" dialog box opens
2	Enter C:\>ping XX XX XX and press Enter → The ping result is displayed ( <a href="#">Figure 31</a> )

Figure 31: Successful Ping Result

```

C:\> Command Prompt
Microsoft Windows [Version 6.1.7601]
Copyright (c) 2009 Microsoft Corporation. All rights reserved.
C:\Users\brownrd>ping 172.16.5.8
Pinging 172.16.5.8 with 32 bytes of data:
Reply from 172.16.5.8: bytes=32 time=2ms TTL=128
Reply from 172.16.5.8: bytes=32 time=1ms TTL=128
Reply from 172.16.5.8: bytes=32 time=1ms TTL=128
Reply from 172.16.5.8: bytes=32 time=1ms TTL=128
Ping statistics for 172.16.5.8:
    Packets: Sent = 4, Received = 4, Lost = 0 (0% loss),
    Approximate round trip times in milli-seconds:
        Minimum = 1ms, Maximum = 2ms, Average = 1ms
C:\Users\brownrd>
    
```

→ If you get a response from that IP address, you are connected to the communication module. If the ping fails and you do not get a response, then there is an issue with the network or the IP settings. Verify the communication module and the PC network settings (see [Configure PC and Network Settings](#)).

## Visual C++ Error

### Symptom

Receive the following Message: "MS/TP Library Load Failed: The application has failed to start because its side-by-side configuration is incorrect. Please see the application event log or use the command-line sxstrace.exe tool for more details."

### Issue

PC is missing a required Microsoft Visual C++ Redistributable Package

### Solution

1. Open Event Log by typing, "Event Viewer" in the search bar of the Windows Start Menu, then clicking the, "Event Viewer" link.
2. In the left pane of the Event Viewer window, click to expand the, "Applications and Services Logs."
3. Click BCM Configuration Tool within the list.
4. From the center pane, double-click the event.
5. In the message pane, locate the version of missing Microsoft Visual C++ Redistributable Package (Figure 32).
6. Locate and install the missing version from Microsoft's website.

**Figure 32: Event Properties Window**

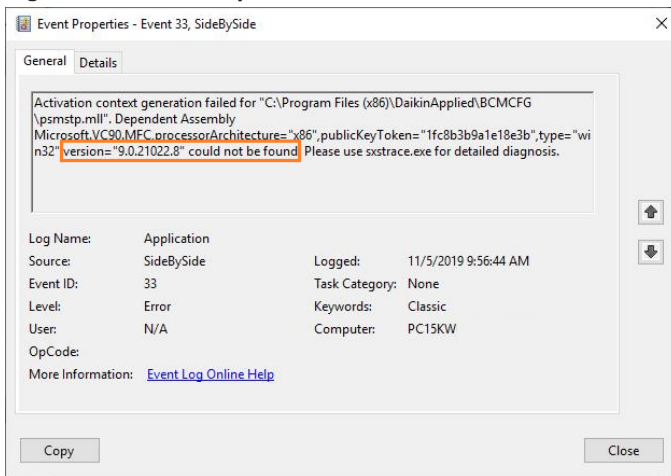

Contact the Daikin Applied Chiller Technical Response Center at 800-432-1342 or [chltechsupport@daikinapplied.com](mailto:chltechsupport@daikinapplied.com) for additional assistance, if necessary.

## Parts

**Table 9: Replacement Parts List**

Description	Part Number
MicroTech II BACnet IP/Ethernet Communication Module kit Kit includes: BACnet communication module and IM 837	350147406

To find your local parts office, visit [www.DaikinApplied.com](http://www.DaikinApplied.com) or call 800-37PARTS (800-377-2787).

Use these instructions to disable Internet Services for GSA facilities and other applications that require enhanced security protection for MicroTech II chiller unit controllers communicating via BACnet IP.

Follow the steps as described in the following sections to:

1. Verify compatibility of BACnet communication module hardware, firmware, and application software files.
2. Upgrade to the latest versions, if necessary.

**NOTE:** These first two steps require Daikin's BACnet Communication Module Configuration (BCM) Tool to view, upload files, and confirm installation.

3. Disable FTP, Telnet, and HTTP services using Daikin's BACnet Web Configuration Interface.
4. Enable Auditing of WriteProperty requests to modify the Present\_Value property of any of the commandable BACnet objects (AO, BV, MO), WriteProperty requests to modify the Object\_Identifier property of the Device Object, DeviceCommunicationControl requests, ReinitializeDevice requests, and AtomicWriteFile requests.
5. Enable the GSA-required disclaimer to the BACnet Web Configuration Interface home page.

### Current Hardware

The Application and Firmware for the Current BACnet IP/Ethernet hardware (Application Software Version: 2.15 and newer, Firmware Revision: AeBCM-2.0.5- BeBCM-485-2.0.5 and newer) supports the enhanced security functionality described above and does not require any updates to add features.

### Previous Hardware

Due to a chip-set change during production of the previous BACnet IP/Ethernet hardware, two different designs of the previous hardware/software exist in the field, Hardware/software Design 1 (shipped approximately 2015-2018) and Hardware/software Design 2 (shipped approximately 2006-2015). These previous hardware designs have different application and firmware versions that are not interchangeable.

Only the following versions of previous BACnet communication module hardware and software support the ability to disable FTP, Telnet, and/or HTTP functionality, and meet the IP network requirements of a GSA facility:

#### Previous Hardware Design 1:

- Firmware Revision AeBCM-12.1 - BeBCM-1.1.5-rc8
- Application Software Version 2.10

#### Previous Hardware Design 2:

- Firmware Revision AeBCM-11.1 - BeBCM-1.1.5-rc7
- Application Software Version 2.10

If the ability to disable FTP, Telnet, and/or HTTP functionality, and meet the IP network requirements of a GSA facility is required for a site and the BACnet IP/Ethernet module does not have the software/firmware prescribed above, the module can be upgraded to support the required functionality. Any combination of revisions/versions below (or older) require an

update prior to disabling Internet Services.

#### Previous Hardware Design 1:

- Firmware Revision: AeBCM-12 - BeBCM-1.1.5-rc8
- Application Software Version: 2.00

#### Previous Hardware Design 2:

- Firmware Revision: AeBCM-11 - BeBCM-1.1.5-rc7 and earlier
- Application Software Version: 2.00 and earlier

**NOTE:** Previous Hardware Design 1 displays "rc8" (or newer) at the end of its Firmware revision string. Previous Hardware Design 2 displays "rc7" or earlier (rc6, rc5, etc.) at the end of its Firmware revision string.

**CAUTION**

1. Please consult with Daikin Applied Chiller Technical Response Center at 800-432-1342 or chltechsupport@daikinapplied.com.
2. Do not update Previous Hardware, Version 1 with Previous Hardware, Version 2 firmware. It may render the device inoperable. Similarly, do not update Previous Hardware Version 2 with Previous Hardware Version 1 firmware for the same reason.
3. If the final versions of the Firmware Revision and Application Software Version are not as expected, the device will require reprogramming at the factory.

## 1. Verify Firmware and Application Software Versions

1. Determine the Firmware revision string from the sticker on the BACnet communication module, or by reading the Device Object using BCM Configuration Tool.
2. Verify and upgrade (if necessary) the firmware and application software versions using the BCM Configuration Tool. Follow the steps below to download the tool to your PC, if this has not been done previously.

**NOTE:** These instructions describe only the portions of the tool that apply directly to BACnet IP. Other configuration options, screens and fields included in the full tool do not apply and can be ignored.

### Using the BCM Configuration Tool

#### Windows Requirements

The BCM Configuration Tool is compatible with Windows 2000 and newer operating system versions.

#### PC Requirements

Ethernet interface and TCP/IP protocol capability:

- Standard web browser such as Internet Explorer™
- Ethernet cable (either an Ethernet crossover cable for direct connection or a standard Ethernet cable for connecting through a hub).

1. Uninstall any previous versions of the BCM Configuration Tool from your PC.
2. Download the BACnet Configuration Tool from [www.DaikinApplied.com](http://www.DaikinApplied.com) and click on the Resources tab. Select Controls from the Application Software



link, and scroll down the list to the file named “BACnet Communication Module (BCM) Configuration Tool Version 2.20 for MicroTech® II Chiller Unit Controllers only.” Click on the file to install the BCM Configuration Tool to the default directory on your PC.

3. Using an Ethernet patch cable, or Ethernet crossover cable (as needed), connect the BACnet communication module directly to the PC that now has the BCM Configuration Tool installed.
4. Using the keypad, verify the “Protocol=” on the Network Config menu of the unit controller is set to BACnet IP.
5. Open the BCM Configuration Tool by double-clicking on BCMCFG.exe from the folder in which it was installed (see Step 2 above).

The default installation path is C:\Program Files\DaikinApplied\BCMCFG for Windows 32-bit installations or C:\Program Files (x86)\DaikinApplied\BCMCFG for Windows 64-bit installations. This path may be overridden at installation time.

- NOTE:** There are two configuration files used by the BCM Configuration Tool (BACLIB.INI and BCMCFG.INI). Normally these files are changed by BCMCFG.exe. They are located in the “AppData” folder. The “AppData” folder is dependent on the user who is currently logged into the PC. For example, if John is logged in using Windows XP, this folder is C:\Documents and also Settings\John\Application Data. For Windows 7 and all other versions, this folder is C:\Users\John\AppData\Roaming.
6. Navigate to the BCM Configuration Tool (Start/Programs/DaikinApplied/Chiller BCM Configuration Tool) or double-click on the desktop icon, if present.
  7. When the BCM Configuration Tool opens, select BACnet/IP from the BACnet MAC Layer Select dialog and click OK (Figure 33).

Figure 33: BACnet MAC Layer Select Dialog Box

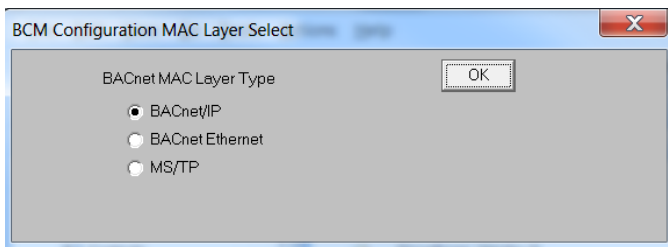

The main page of the BACnet Communication Module Configuration Tool opens and defaults to the BACnet Device tab (Figure 34).

8. Enter the Device Instance of the BACnet communication module in the BCM Device Instance field the top left portion of the BACnet Device tab.
9. Click the Read Object List button. If the BCM Configuration Tool is communicating with the module, it counts from 0 to 131 (or 62).
10. After the BCM Configuration Tool has successfully

counted from 0 to 131 (or 62), press the Read button in the upper left portion of the screen.

Figure 34: BACnet Device Tab

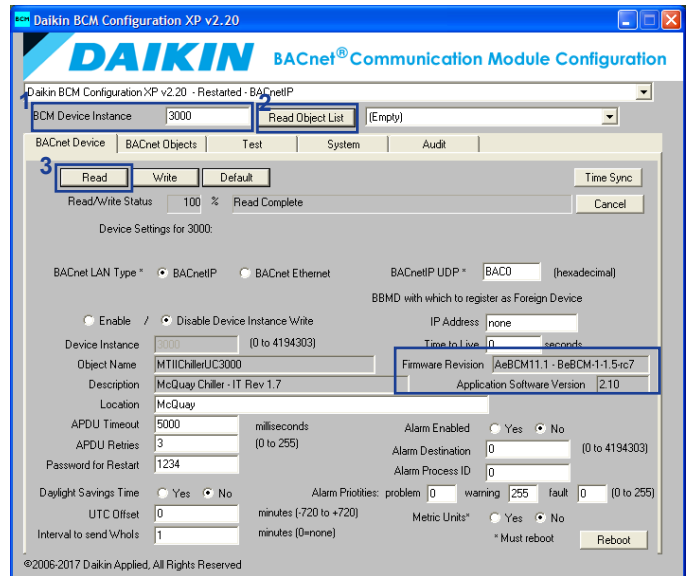

11. Once the Read/Write Status field counts up to 100%, verify the firmware and application software are listed in the **Current Hardware** section.
  - a. If the files are compatible as detailed in **Current Hardware**, proceed to **3. Disable FTP, Telnet, and HTTP Services**.
  - b. If the files are not compatible as detailed in **Previous Hardware**, follow the steps directly below to upgrade firmware files before proceeding to **3. Disable FTP, Telnet, and HTTP Services**.

## 2. Upgrade BACnet Communication Module Firmware

Follow these instructions to upgrade firmware based on which version of BACnet communication module hardware is present.

**NOTE:** The BACnet Communication Module (BCM) Configuration Tool must be installed on your PC before proceeding (see **1. Verify Firmware and Application Software Versions**).

### Upgrade for Hardware Version 1

1. Contact the Daikin Applied Chiller Technical Response Center at 800-432-1342 or chltechsupport@daikinapplied.com to request a copy of the DaikinBCMSuperWeb16.zip file via email.
2. Double-click on the DaikinBCMSuperWeb16.zip file attachment and unzip it to any folder on your PC. This creates a single file named flash\_apps.bin in that folder.
3. Using an Ethernet patch cable, or Ethernet crossover cable (as needed), connect the BACnet communication module directly to the PC.

- Open the BCM Configuration Tool. From the Device tab, confirm the Firmware Revision is AeBCM-12 - BeBCM-1.1.5-rc8 and the Application Software Version is 2.00.

If the BACnet communication module displays “rc7” or earlier (rc6, rc5, etc.) at the end of its Firmware revision string, it is a Hardware Version 2 device. Proceed to the instructions in the next section ([Upgrade for Hardware Version 2](#)).

- Navigate to the System tab and click Browse to locate the unzipped flash\_apps.bin file. Click the flash\_apps radio button and download it to the BACnet communication module
- Navigate back to the Device tab and select Reboot to restart the BACnet communication module once the download is complete.

**NOTE:** A reboot is required as the BACnet communication module does NOT automatically restart even though it indicates this is the case.

- After the reboot is complete, confirm the Firmware Revision is AeBCM-12.1 – BeBCM-1.1.5-rc8 and the Application Software Version is 2.10 from the Device tab.
- Proceed to Step 3 to disable Internet Services.
- Optional: refer to [BACnet Auditing](#) if you wish to use the features available in the BCM Configuration Tool’s Audit tab.

### Upgrade for Hardware Version 2

- Contact the Daikin Applied Chiller Technical Response Center at 800-432-1342 or chltechsupport@daikinapplied.com to request a copy of the DaikinBCM16.zip file via email.
- Double-click on the DaikinBCM16.zip file attachment and unzip it to any folder on your PC. This creates one file named flash\_apps.bin and one file named flash\_sys.bin in that folder.
- Using an Ethernet patch cable, or Ethernet crossover cable (as needed), connect the BACnet communication module directly to the PC.
- Open the BCM Configuration Tool. From the Device tab, confirm the Firmware Revision is similar to AeBCM-xx – BeBCM-1.1.5-yy, where xx displays 11, 10, etc., and yy displays rc7, rc6, etc. The Application Software Version displays 2.00, 1.26, or similar.  
If the Firmware Revision is AeBCM-11-BeBCM-1.1.5-rc7, skip to Step 6.
- If the Firmware Revision is NOT AeBCM-11- BeBCM-1.1.5-rc7, open the BCM Configuration Tool. From the Device tab, select the unzipped flash\_sys.bin file, click the flash\_sys radio button, and download it to the BACnet communication module.
- Navigate back to the Device tab and select Reboot to restart the BACnet communication module once the download is complete.

**NOTE:** A reboot is required as the BACnet communication

module does NOT automatically restart even though it indicates this is the case.

- After the reboot is complete, confirm the Firmware Revision is AeBCM-xx – BeBCM-1.1.5-rc7 and the Application Software Version is 2.00, 1.26, or similar. Note that AeBCM-xx and Application Software Version have remained unchanged.
- Navigate to the System tab and click Browse to locate the unzipped flash\_apps.bin file. Click the flash\_apps radio button and download it to the BACnet communication module.
- Navigate back to the Device tab and select Reboot to restart the BACnet communication module once the download is complete.

**NOTE:** A reboot is required as the BACnet communication module does NOT automatically restart even though it indicates this is the case.

- After the reboot is complete, confirm the Firmware Revision is AeBCM-11.1 - BeBCM-1.1.5-rc7 and the Application Software Version is 2.10 from the Device tab.
- Proceed to Step 3 to disable Internet Services.
- Optional: refer to [BACnet Auditing](#) if you wish to use the features available in the BCM Configuration Tool’s Audit tab.

### 3. Disable FTP, Telnet, and HTTP Services

Once the latest firmware and application software files have been installed, use the BACnet Web Configuration Interface to disable the Internet Services as follows:

**NOTE:** GSA Facilities *must* disable these features.

- Connect the BACnet communication module via the Ethernet port.
- Open your web browser and enter the IP address of the BACnet communication module (default is 172.16.5.8) in the Address box.
- Press Enter to access the BACnet Web Configuration Interface.
- Click the Go to Configure/Test link at the bottom of the BACnet Web Configuration Interface home page.
- Enter the User Name “admin” and Password “fadmin.” Note that these are the defaults and can be changed.
- Press OK.
- Click System Configuration on the left hand side
- Select the Network tab.
- For GSA facilities only - from the drop down menu, select “Yes” in the Facility Type drop down box ([Figure 35](#)).

**Figure 35: GSA Facility Selection**

**Facility Type**  
 GSA Facility(Yes/No): No ▾

**NOTE:** Selecting “Yes” for a GSA Facility Type enables the GSA-required disclaimer to appear on the BACnet Web Configuration Interface home page (Figure 36).

**Figure 36: GSA Message**

**BACnet Communication Module (BCM) Home Page**

\*\*\*\*\*WARNING\*\*\*\*\*  
 This is a U.S. General Services Administration Federal Government computer system that is "FOR OFFICIAL USE ONLY." This system is subject to monitoring. Therefore, no expectation of privacy is to be assumed. Individuals found performing unauthorized activities are subject to disciplinary action including criminal prosecution.

[Confirm Warning](#)

10. Select Disable for HTTP Service, FTP Service, Telnet Service.
11. Select Reboot.

**WARNING**

After the reboot is complete, you will no longer have HTTP, FTP or Telnet access without a special reboot sequence which only gives you temporary access (see [Reset or Restore Communication Module to Factory Defaults](#)).

12. Click Save.
13. Close the browser.

**BACnet Auditing**

BACnet auditing and logging is supported in chiller BACnet IP communication modules installed with application software version 2.10 and later. The BCM Configuration Tool’s Audit tab (Figure 37 and Table 10) allows you to read and write selected BACnet properties, upload, and clear BACnet audit and data files.

**Figure 37: BACnet Audit Tab**

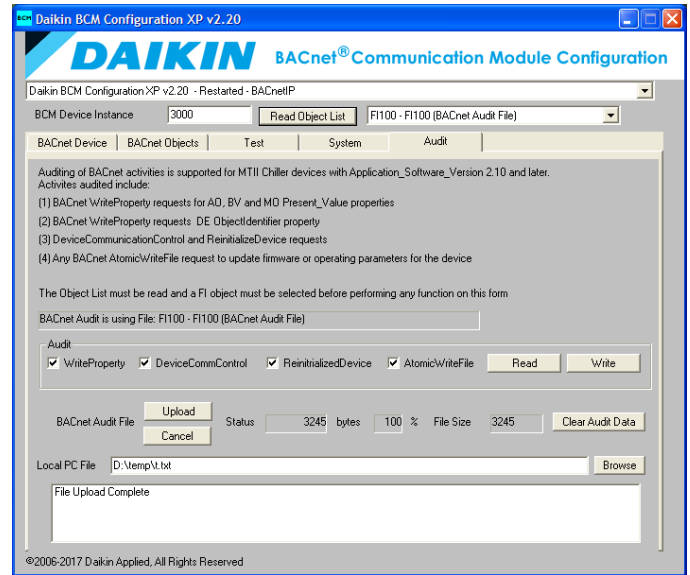

**Table 10: Audit Tab Details**

Property/Button	Description
(Audit)WriteProperty	Indicates if all WriteProperty requests to the PresentValue property of all commandable objects and to the ObjectIdentifier of the Device Object are logged.
(Audit)DeviceComm Control	Indicates if all DeviceCommunicationControl requests are logged.
(Audit)Reinitialize Device	Indicates if all ReinitializeDevice requests are logged.
(Audit)AtomicWrite File	Indicates if all AtomicWriteFile requests for firmware updates and CSV file downloads are logged.
Read Button	Reads the all the Audit properties for the device
Write Button	Writes the all the writeable Audit properties for the device except for the File_Size.
Browse Button	Allows you to select the Audit/Log file to upload into. Another option is to type the complete file name into the Local PC File field.
Local PC File	Contains the location of the file to be downloaded.
Upload Button	Reads the BACnet (log) file selected in the Object List into the PC file selected in the Local PC File field.
Status bytes %	Indicates the upload progress in bytes and as a percentage (%) of the total bytes to be downloaded.
Clear Audit Data Button	Clears the data in the Audit/Log file selected in the Object List for the BACnet communication module by writing 0 to the File Size.

**Customer Support**

Daikin Applied Chiller Technical Response Center at 800-432-1342 or [chltechsupport@daikinapplied.com](mailto:chltechsupport@daikinapplied.com).





### ***Daikin Applied Training and Development***

Now that you have made an investment in modern, efficient Daikin equipment, its care should be a high priority. For training information on all Daikin HVAC products, please visit us at [www.DaikinApplied.com](http://www.DaikinApplied.com) and click on Training, or call 540-248-9646 and ask for the Training Department.

### ***Warranty***

All Daikin equipment is sold pursuant to its standard terms and conditions of sale, including Limited Product Warranty. Consult your local Daikin Applied representative for warranty details. To find your local Daikin Applied representative, go to [www.DaikinApplied.com](http://www.DaikinApplied.com).

### ***Aftermarket Services***

To find your local parts office, visit [www.DaikinApplied.com](http://www.DaikinApplied.com) or call 800-37PARTS (800-377-2787). To find your local service office, visit [www.DaikinApplied.com](http://www.DaikinApplied.com) or call 800-432-1342.

This document contains the most current product information as of this printing. For the most up-to-date product information, please go to [www.DaikinApplied.com](http://www.DaikinApplied.com).

Products manufactured in an ISO Certified Facility.