

Operation and Maintenance Manual

IM 1133-3

Group: **Controls**
Part Number: **IM 1133-3**
Date: **August 2023**
Supersedes: **IM 1133-2**

DIII-NET Communication Gateway For Daikin Applied Air Handling Units integrated with a Daikin Applied VRV System

Applied Rooftop Model: RPS, RDT & RAH
Commercial Rooftop Model: DPS & MPS
Self-Contained Model: SWP & SWT

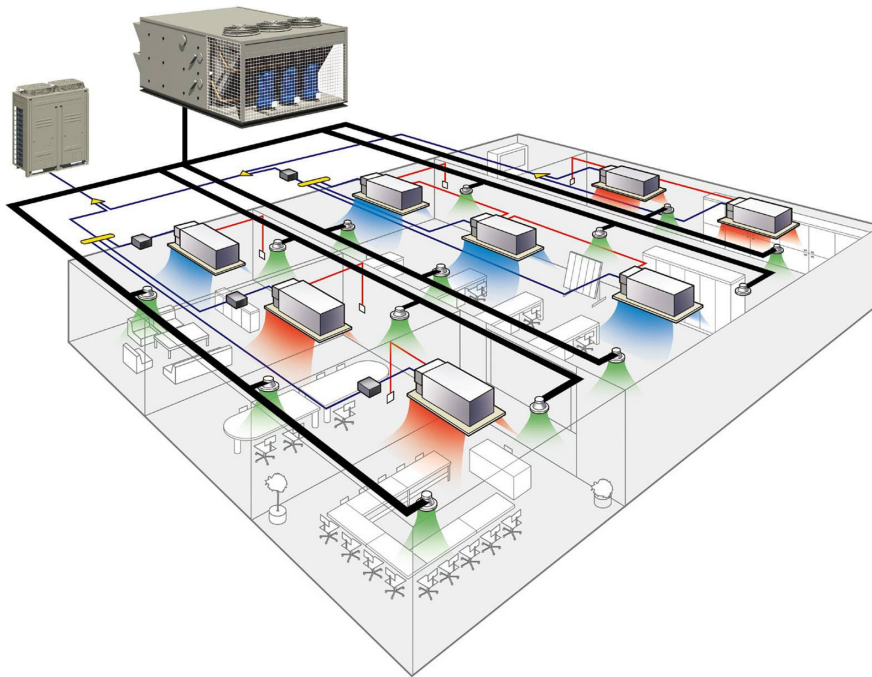

Contents

FIGURES	3
REVISION HISTORY	4
REFERENCE DOCUMENTS.....	4
LIMITED WARRANTY.....	4
GENERAL INFORMATION.....	5
HAZARD IDENTIFICATION MESSAGES.....	5
RECOGNIZE SAFETY SYMBOLS, WORDS AND LABELS.....	5
DESCRIPTION.....	6
APPLICATION.....	6
COMPONENT DATA	7
<i>Light Emitting Diodes (LEDs)</i>	7
INSTALLATION.....	8
WIRING	8
<i>Installing a New DIII-NET Communication Gateway.....</i>	8
<i>Replacing an Existing DIII-NET Communication Gateway.....</i>	11
INTEGRATION.....	12
CONFIGURING THE DIII-NET COMMUNICATION GATEWAY	12
<i>DIII-NET Communication Gateway Addressing</i>	13
<i>Configuring the DIII Board and MicroTech Unit Controller</i>	14
INTELLIGENT TOUCH CONTROLLER CONFIGURATION.....	15
<i>Change an Icon on the Intelligent Touch Controller.....</i>	15
<i>Creating a New Zone and Setting the Intelligent Touch Controller Dead Band</i>	17
INTELLIGENT TOUCH CONTROLLER OPERATION	20
<i>MicroTech Unit Controller Operation.....</i>	20
<i>Adjusting Discharge Air Setpoint.....</i>	21
<i>Adjusting Fan Speed.....</i>	22
iTOUCH MANAGER CONFIGURATION	24
<i>Auto Register a Unit to the iTouch Manager</i>	24
<i>Manually Add a Unit to the iTouch Manager.....</i>	26
<i>Changing Icon and Description on iTouch Manager</i>	29
iTOUCH MANAGER OPERATION	31
<i>Turning a Unit On and Off.....</i>	31
<i>Adjusting Setpoints</i>	32
<i>Changing Fan Speed.....</i>	32
<i>Advanced Settings.....</i>	33
SERVICE INFORMATION	36
TEST PROCEDURES	36
PARTS LIST.....	36
<i>Communication Board</i>	36
<i>Field Install Kit.....</i>	36
APPENDIX A	37
ALARMS	37
APPENDIX B	38
CONFIGURABLE PARAMETERS.....	38

Figures

Figure 1, Maverick II Rooftop Unit6

Figure 2, DIII-NET Communication Gateway Installed7

Figure 3, Mounting bracket installed in unit8

Figure 4, DIII-NET Communication Gateway mounted in unit9

Figure 5, DIII-NET Communication Gateway Schematics9

Figure 6, Incorporating DIII-NET board into an existing Modbus Daisy Chain10

Figure 7, DIII-NET Wiring Schematic10

Figure 8, DIP Switch Configuration11

Figure 9 MicroTech Unit Controller Menu Structure13

Figure 10, Zone Screen on Intelligent Touch Controller15

Figure 11, System Setting Screen Shot, Intelligent Touch Controller15

Figure 12, Zone/Group Selection Screen, Intelligent Touch Controller15

Figure 13, Zone / Group Screen 16

Figure 14, Group Settings Screen 16

Figure 15, All Zones Display on Intelligent Touch Controller17

Figure 16, System Settings Screen17

Figure 17, System Menu for Selecting Zone/Group17

Figure 18, System Zone Group Screen18

Figure 19, System Menu for Setting up New Zone18

Figure 20, Configure Screen for Setting Setpoint Range19

Figure 21, Setpoint Range Configuration Screen19

Figure 22, MicroTech Air Handling Unit in Occupied Mode20

Figure 23, MicroTech Air Handler Unit in Unoccupied Mode20

Figure 24, MicroTech Air Handler in Unoccupied Operation21

Figure 25, With MicroTech Air Handling Unit Selected21

Figure 26, Configure Screen for MicroTech Air Handling Unit Std Version22

Figure 27, Configure Screen for MicroTech Air Handling Unit US Version22

Figure 28, MicroTech Air Handling Unit Selected23

Figure 29, Advanced Settings Configuration Screen23

Figure 30, iTouch Manager Home Screen24

Figure 31, Accessing Service Login24

Figure 32, Service Login Screen 25

Figure 33, Service Login Menu List – Auto Register25

Figure 34, Auto Register Screen 25

Figure 35, Confirm Auto Register Changes26

Figure 36, Service Login Menu List – Manually Register26

Figure 37, Add Management Point to iTouch Manager27

Figure 38, Management Point Type27

Figure 39, Setting Unit Address and Name28

Figure 40, DIII Address Drop-down Menu 27

Figure 41, Setting Unit Name 28

Figure 42, New Management Point on iTouch Manager28

Figure 43, Confirm Register Data Point28

Figure 44, Unit Selected for Editing29

Figure 45, Editing Unit Information29

Figure 46, Entering Detailed Information30

Figure 47, Icon Selection 30

Figure 48, Turning Unit On and Off31

Figure 49, Confirm Start/Stop Unit31

Figure 50, Adjusting Setpoints from the iTouch Manager32

Figure 51, Adjusting Fan Speed from the iTouch Manager33

Figure 52, Accessing Detailed Settings33

Figure 53, Detailed Settings Screen34

Figure 54, Setpoint Restrictions 34

Revision History

IM 1133	August 2011	Initial release
IM 1133-RevB	November 2013	Revised and expanded on adding a new DIII board to an existing unit, updated all figure numbers. Sections added on iTouch configuration and operation; includes 27 new Figures.
IM 1133-RevD	June 2019	Added Rebel® DPS to cover
IM 1133-3	August 2023	MicroTech® branding update

Reference Documents

Number	Company	Title	Source
OM 920	Daikin Applied	MicroTech Applied Air Handling Unit Controller Operation and Maintenance Manual	www.DaikinApplied.com
IM 919	Daikin Applied	MicroTech Applied Air Handling Unit Controller Installation Manual	www.DaikinApplied.com
DCS601C71	Daikin Applied Air Conditioning Americas	Intelligent Touch Controller Installation Manual	www.daikinac.com
DCM601A71	Daikin Applied Air Conditioning Americas	intelligent Touch Manager Installation Manual	www.daikiac.com
EM11A017A	Daikin Applied Air Conditioning Americas	intelligent Touch Manager User’s Manual	www.daikinac.com
ED72-423	Daikin Applied Air Conditioning Americas	Design Guide Intelligent Touch Controller	www.daikinac.com
EM11A022	Daikin Applied Air Conditioning Americas	intelligent Touch Manager Commissioning Manual	www.daikinac.com

Limited Warranty

Consult your local Daikin Applied Representative for warranty details. Refer to Form 933-43285Y. To find your local Daikin Applied representative, go to www.DaikinApplied.com.

Notice

© 2023 Daikin Applied, Minneapolis MN. All rights reserved throughout the world. Daikin Applied reserves the right to change any information contained herein without prior notice. The user is responsible for determining whether this software is appropriate for his or her application.

® ™ The following are tradenames or registered trademarks of their respective companies: Modbus from Schneider Electric; Daikin Applied, RoofPak, Maverick, Rebel, and MicroTech from Daikin Applied.

General Information

This manual contains the information you need to install the DIII-NET Communication Gateway on a MicroTech® Applied Air Handling Unit (AAH) Controller (i.e., RoofPak® applied rooftop, Maverick® II commercial rooftop or Self-Contained Unit), incorporate it into the DIII-Net network, and maintain it.

Hazard Identification Messages

Recognize Safety Symbols, Words and Labels

The following symbols and labels are used throughout this manual to indicate immediate or potential hazards. It is the owner and installer's responsibility to read and comply with all safety information and instructions accompanying these symbols. Failure to heed safety information increases the risk of property damage and/or product damage, serious personal injury or death. Improper installation, operation and maintenance can void the warranty.

DANGER

Dangers indicate a hazardous situation which will result in death or serious injury if not avoided.

WARNING

Warnings indicate potentially hazardous situations, which can result in property damage, severe personal injury, or death if not avoided.

CAUTION

Cautions indicate potentially hazardous situations, which can result in personal injury or equipment damage if not avoided.

WARNING

Electric shock hazard. Can cause personal injury or equipment damage.

This equipment must be properly grounded. Connections and service to the MicroTech Air Handling Unit Controller must be performed only by personnel knowledgeable in the operation of the equipment being controlled.

CAUTION

Static sensitive components. Can cause equipment damage.

Discharge any static electrical charge by touching the bare metal inside the control panel before performing any service work. Never unplug cables, circuit board terminal blocks, or power plugs while power is applied to the panel.

NOTICE

This equipment generates, uses and can radiate radio frequency energy and, if not installed and used in accordance with this instruction manual, may cause interference to radio communications. It has been tested and found to comply with the limits for a Class A digital device, pursuant to part 15 of the FCC rules. These limits are designed to provide reasonable protection against harmful interference when the equipment is operated in a commercial environment. Operation of this equipment in a residential area is likely to cause harmful interference in which case the user will be required to correct the interference at his or her own expense. **Daikin Applied disclaims any liability resulting from any interference or for the correction thereof.**

⚠ WARNING

Electric shock hazard. Can cause personal injury or equipment damage.

This equipment has exposed electrical connections inside DIII-Net Communication Gateway. Only personnel that are knowledgeable in the operation of this equipment must perform connections and service to the DIII-NET-Net Communication Gateway.

Description

The DIII-NET Communication Gateway allows communication between the MicroTech unit controller and the Daikin Applied variable air volume (VRV) DIII network via a Modbus[®] communication Gateway (DIII-NET Communication Gateway).

Figure 1, Maverick II Rooftop Unit



Application

The MicroTech unit controller will act as a Modbus master device communicating with the DIII-NET Communication Gateway acting as a Modbus slave device. The DIII-NET Communication Gateway will translate the Modbus point information into the DIII-NET protocol and vice-versa.

Component Data

Major components of the DIII-NET Communication Gateway are labeled in .

Figure 2, DIII-NET Communication Gateway Installed

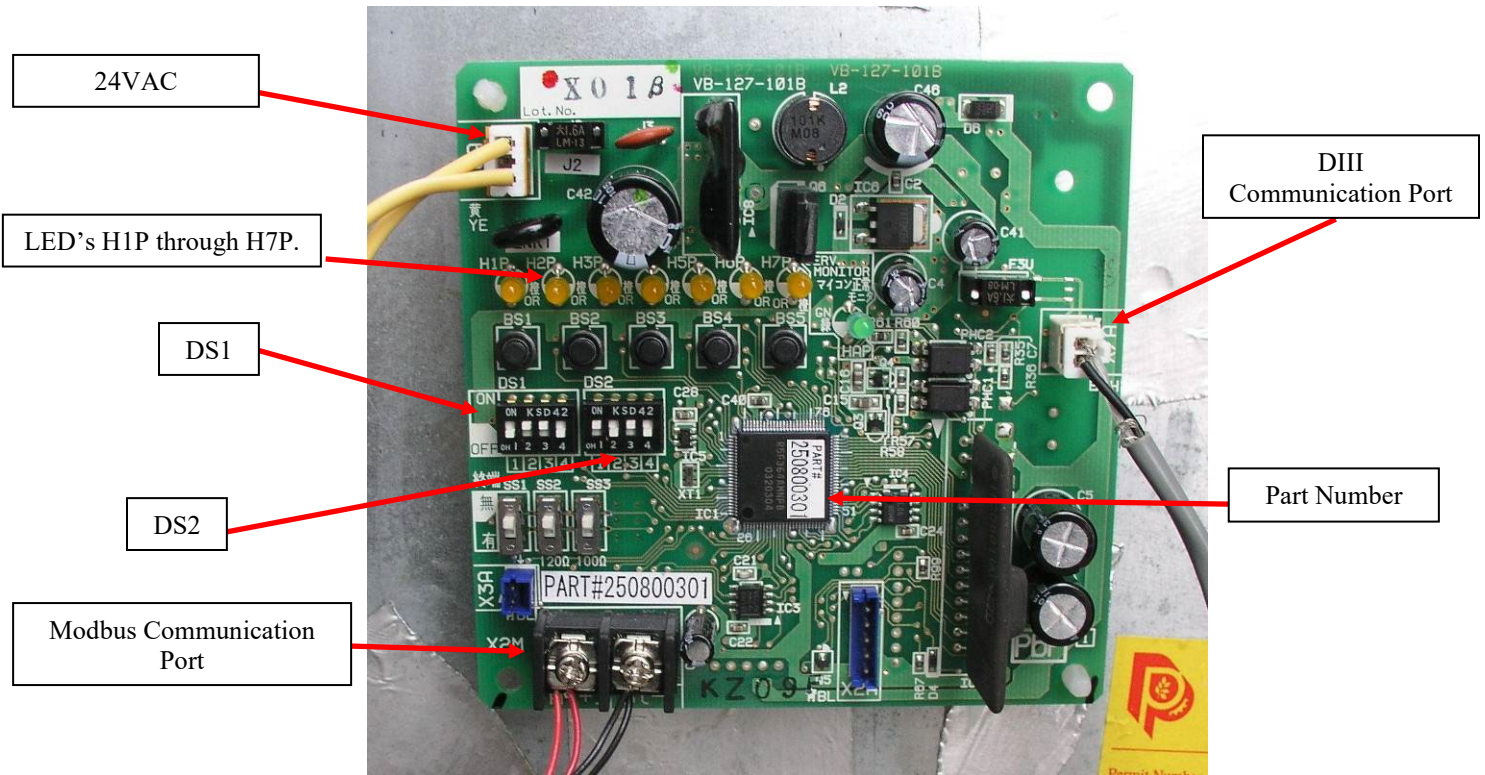

Light Emitting Diodes (LEDs)

The LED's on the DIII-NET Communication Gateway are used to indicate either the DIII-NET Communication Gateway is working correctly or there is a fault. A description of what each of the LEDs being energized or de-energized means is listed in Table 1.

Table 1, LED's

LED	Function	OFF	ON
H1P	DIII-NET Sending	Not Transmitting	Transmitting
H2P	DIII-NET Receiving	Not Receiving	Receiving
H3P	Modbus Sending	Not Transmitting	Transmitting
H4P	Modbus Receiving	Not Receiving	Receiving
H5P	MicroTech Fault Indication	No Faults	Fault Alarm
H6P	MicroTech Problem Indication	No Problems	Problem Alarm
H7P	MicroTech Warning Indication	No Warnings	Warning Alarm
HAP	Micro Processor Operation	800ms Flashing Period Indicates Operation	

Installation

The DIII-NET Communication Gateway will be factory installed. If it is necessary to replace this board, see section [Replacing DIII-NET Communication Gateway](#). If a new board is being installed on an existing unit, see section [Installing a New DIII-NET Communication Gateway](#).

Wiring

⚠ CAUTION

Electrostatic discharge hazard.

Can cause equipment damage.

This equipment contains sensitive electronic components that may be damaged by electrostatic discharge from your hands. Before you handle a communications module, you need to touch a grounded object, such as the metal enclosure, in order to discharge the electrostatic potential in your body.

Installing a New DIII-NET Communication Gateway

⚠ WARNING

Hazardous voltage. Can cause severe injury or death. Disconnect electric power before servicing equipment. More than one disconnect may be required to de-energize the unit.

1. Remove power from the MicroTech Applied Air Handling Unit Controller.
2. Remove power from the Daikin Applied Air Handling Unit.
3. Install mounting bracket on the side wall of the control cabinet with 4 rivets/screws, see Figure 3.
4. Mount DIII-NET Communication Gateway to the mounting bracket with 4 standard circuit board standoffs. Verify the board is securely attached to the mounting bracket. See Figures 3 and 4.

Figure 3, Mounting bracket installation

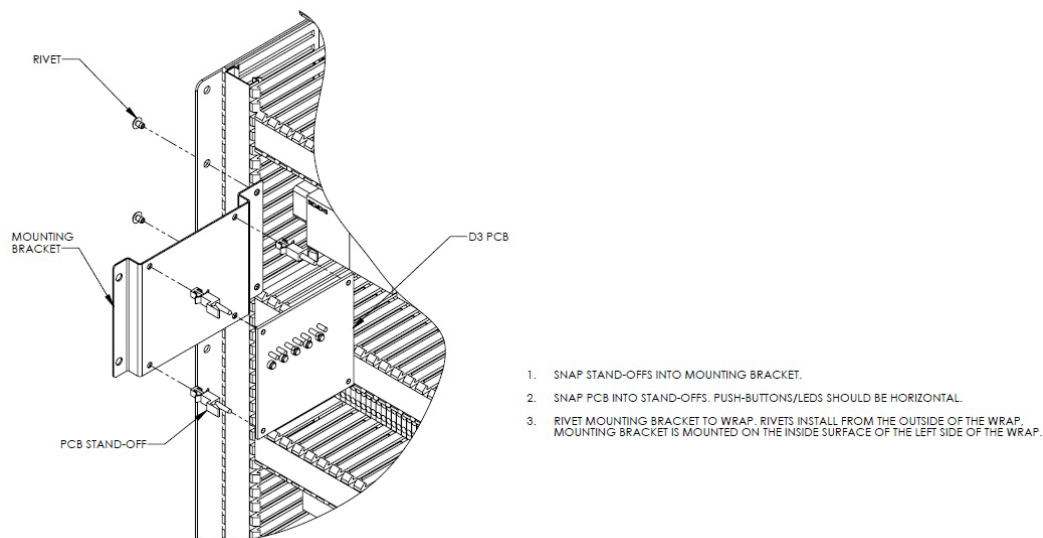

5. Install 120/24 VAC transformer in the control cabinet. *The DIII-NET Communication Gateway must have its own, power supply.*
6. Wire 120VAC power to the transformer using open terminals from the T1 transformer inside the unit control cabinet. The secondary of this transformer must remain ungrounded.

Figure 4, DIII-NET Communication Gateway mounted in unit

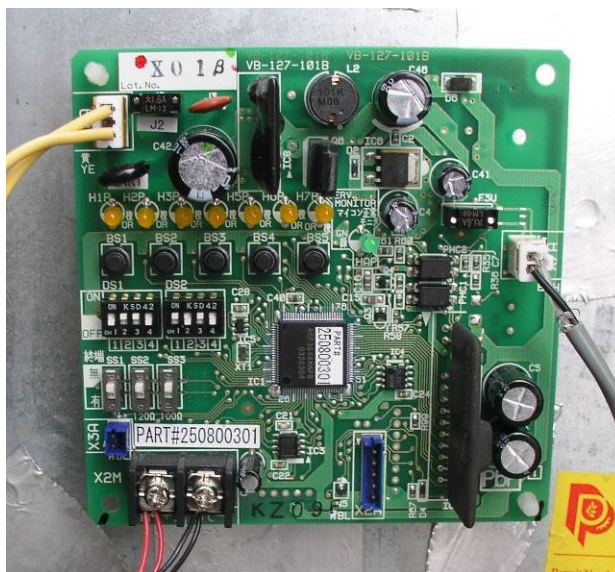

7. Connect the 24VAC power from the transformer to X6A on the DIII-NET Communication Gateway using the provided wire harness. See Figure 5.
8. If there are fewer than 2 pairs of modbus wires going to the MCB, skip to step 11. If there are 2 pairs continue with step 9.
9. Remove 1 pair of modbus wires from the MCB. (A positive and its associated negative.) *Note: the 2 wires removed must be a pair connecting the same two devices.* See Figure 6.
10. Attach the disconnected wires from the MCB to the Modbus Communication Port (X2M) on the DIII-NET Communication Gateway. (+ to terminal A, and - to terminal B.) See Figure 5.

Figure 5, DIII-NET Communication Gateway Schematics

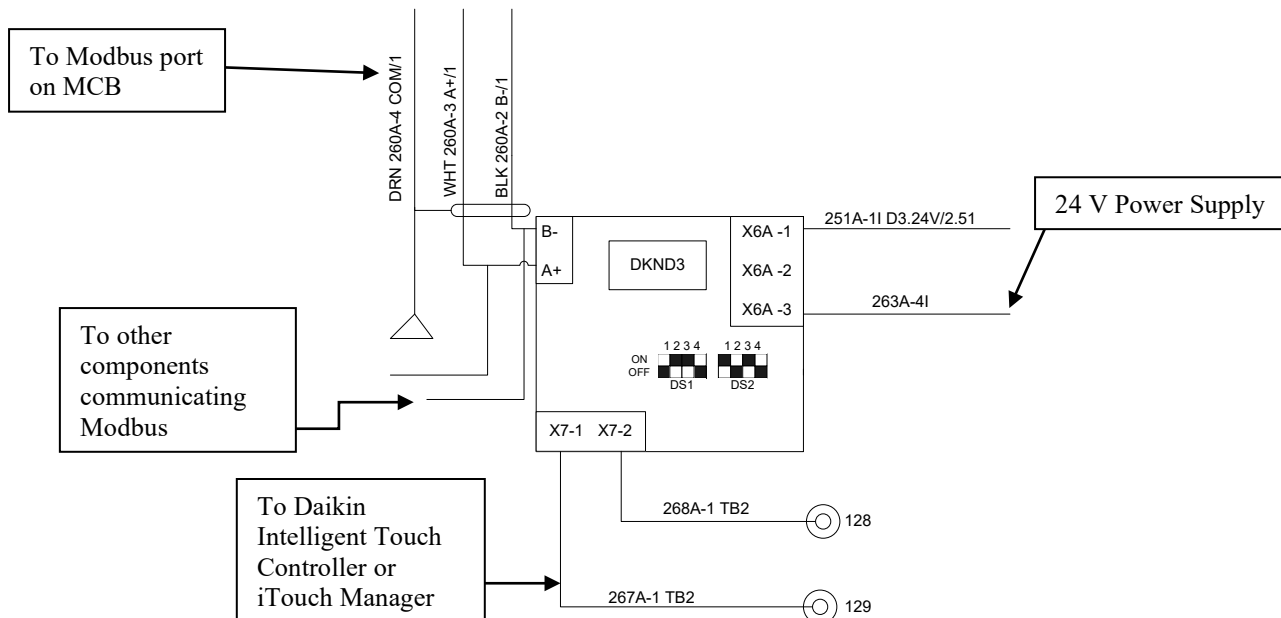
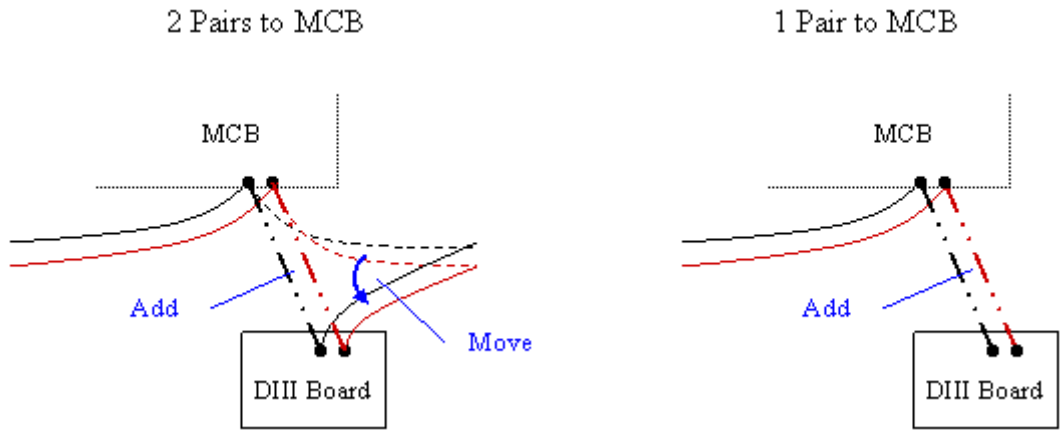
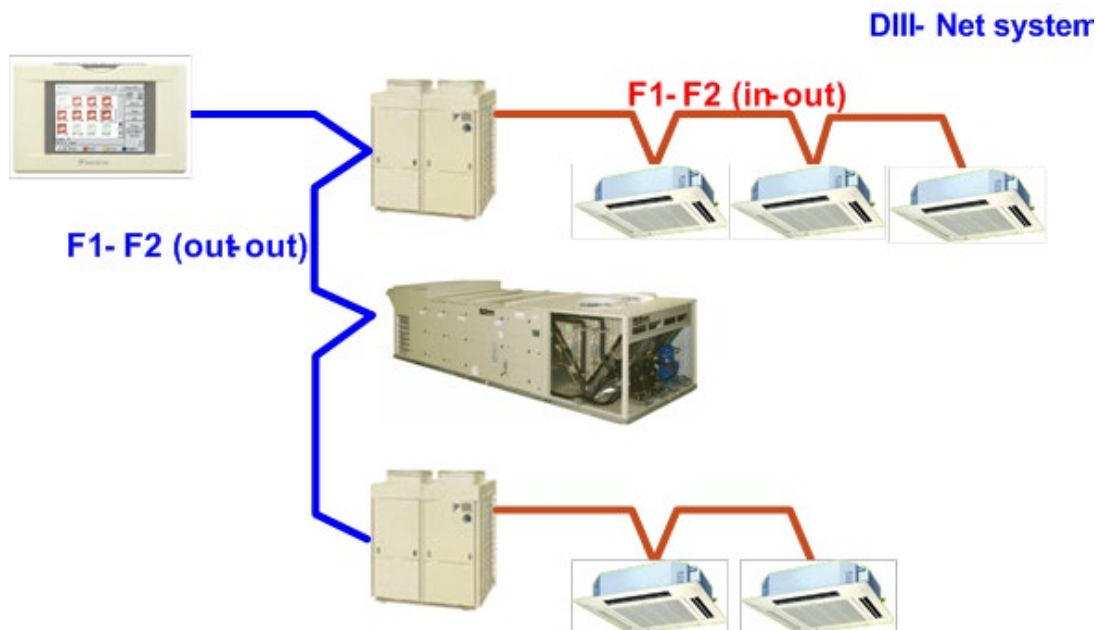

Figure 6, Incorporating DIII-NET board into an existing Modbus Daisy Chain



11. Connect a pair of wires from the MCB to the Modbus Communication Port (X2M) on the DIII-NET Communication Gateway. See Figure 5. (There should be 2 pairs of modbus wires connected to the MCB at this point, unless there were none to begin with, see Figure 6.)
12. The DIII-NET Communications Gateway is treated like any other outdoor unit on the DIII-NET communications trunk. Connect DIII-NET communication wires from the outdoor unit trunk to the DIII-NET communications port (X7A), using the provided wire harness. See Figure 7. Polarity does not matter. For more information on DIII-Net communications wiring refer to Manual DCS601C71

Figure 7, DIII-NET Wiring Schematic



13. Position the binary DIP switches on the DIII-NET Communication Gateway to “0110 1010” as configured in Figure 8.
14. Power up the Daikin Applied Air Handling Unit, MicroTech Unit Controller and DIII-NET Communication Gateway.
15. Configure MicroTech and Daikin Applied VRV unit controllers as instructed in the [Integration section](#). For information on the iTouch Manager, refer to user’s manual EM11A017.

Figure 8, DIP Switch Configuration

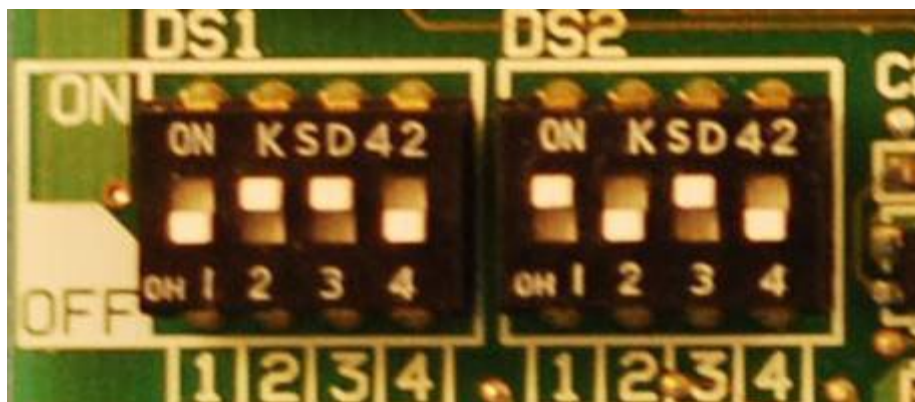

In Figure 8, flipping the binary switches up is on, and flipping them down is off. Switches should be configured to 0110 1010 as shown.

Replacing an Existing DIII-NET Communication Gateway

To replace a DIII-NET Communication Gateway:

⚠ WARNING

Hazardous voltage. Can cause severe injury or death. Disconnect electric power before servicing equipment. More than one disconnect may be required to de-energize the unit.

1. Remove power from the Daikin Applied Air Handling Unit.
2. Disconnect all wiring to DIII-NET Communication Gateway.
3. Remove old DIII-NET Communication Gateway from its mountings.
4. Replace with new DIII-NET Communication Gateway in same manner as the old board. Verify the board is securely attached to the unit. See Figure 4.
5. Reconnect all wiring. See Figure 2. *Use the existing wires only if they are in good condition; do not attempt to use worn or damaged wires under any circumstances. See the “Service Information” section of this document for a list replacement parts.*
6. Confirm binary switches per instructions in step 13 of section “Installing a New DIII-NET Communication Gateway.” See Figure 8.
7. Power up the Daikin Applied Air Handling Unit.
8. Confirm address and parameters on unit controller, as per instructions in the [Integration section](#)

Integration

Once the DIII-NET Communication Gateway has been properly installed on the unit and connected to a DIII network, it is then possible to integrate the unit controller with a Daikin Applied Intelligent Touch Controller or iTouch Manager over a DIII network. The integration process is described in the following section.

Configuring the DIII-NET Communication Gateway

The MicroTech Applied Air Handling Unit Controller and optional DIII-NET Communication Gateways are designed, programmed, and configured at the factory. However, the DIII-NET Communication Gateway needs to have a unique indoor unit address compatible with the existing DIII network. This address and any other configurations can be set through the keypad on the MicroTech Unit Controller. The unit is ready to operate with the default parameter values in the unit controller even before you change the default parameters for your particular network. Appendix B lists the menu items for the “D3 Set-Up Menu” and “D3 Status Menu.”

Note: Refer to Operation Manual OM 920 for details regarding the MicroTech Applied Air Handling Unit Controller keypad/display. Manual is available at www.DaikinApplied.com

DIII-NET Communication Gateway Addressing

Before a unit can be viewed and controlled through a DIII network, the DIII-NET Communication Gateway must be assigned a DIII address. Configuring the DIII board is done through the MicroTech unit controller. The following diagram in Figure 9 details the menu structure of the MicroTech Applied Air Handling Unit Controller related to the DIII-NET Communication Gateway.

Figure 9 MicroTech Unit Controller Menu Structure

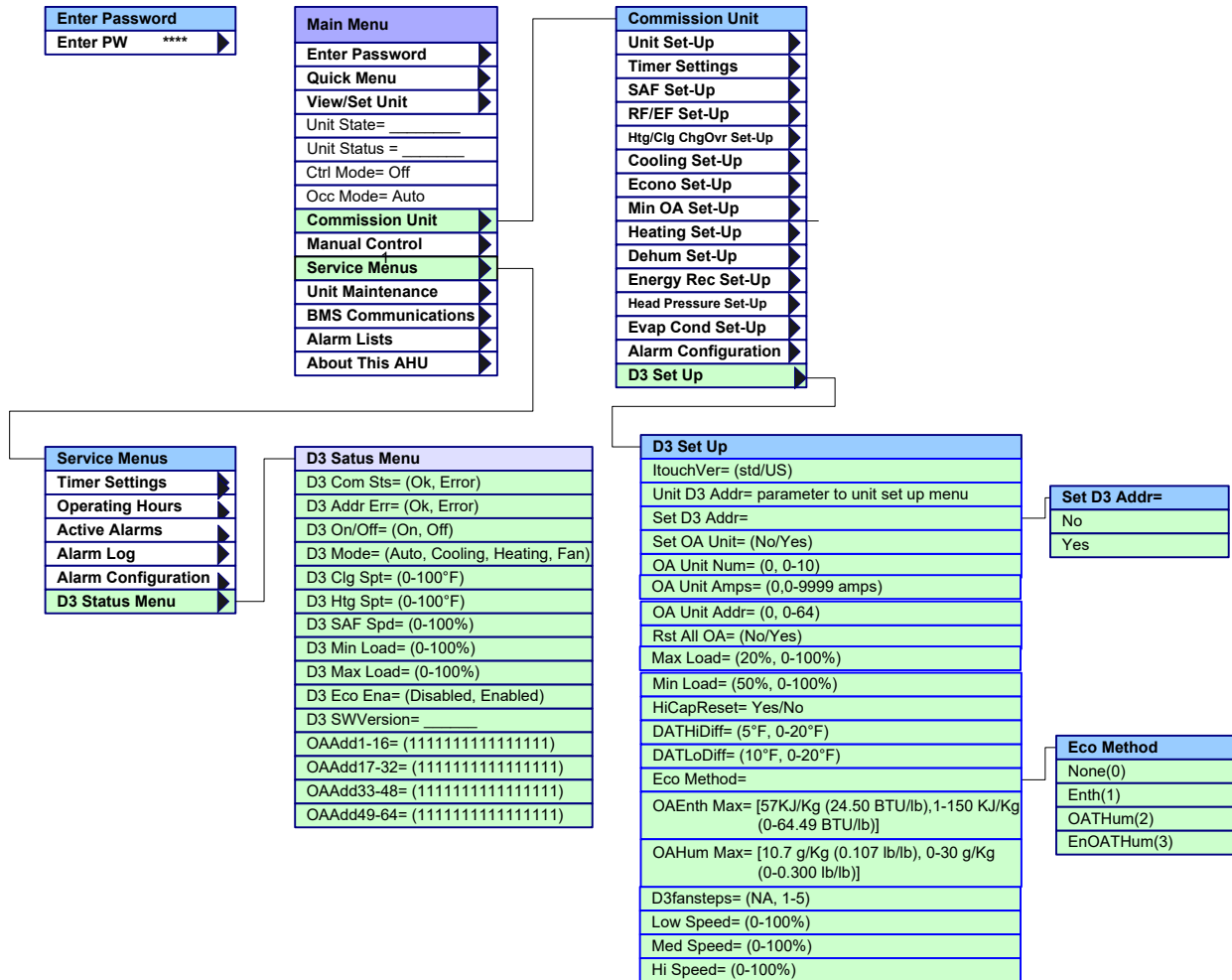

To set the DIII-NET Communication Gateway’s address through the MicroTech Unit Controller:

1. Navigate to the Enter Password screen if you have not already entered a password. If you have entered a password, skip to step 3.
2. Enter Password: 6363.
3. Navigate to “D3 Set Up Menu” under Commission Unit
4. In the D3 Set-Up menu, select Set “Unit D3 addr”
5. Set the unit’s DIII address. Each unit on the DIII network must have a unique address. This is the parameter used by the intelligent Touch Controller/Manager to identify a particular unit.
6. Change “Set D3 addr” to “Yes” this should automatically switch back to “No” after a few seconds. This menu item saves the address from Step 5. *Changes to the D3 address will not be saved if the address is not set.*

Configuring the DIII Board and MicroTech Unit Controller

1. Navigate to the Enter Password screen if you have not already entered a password. If you have entered a password, skip to step 3.
2. Enter Password: 6363.
3. Navigate to Commission Unit\D3 Set Up menu
4. In the D3 Set-Up menu, set “ITouch Version” as desired
 - a. **“USw/Spt”** – For use with Intelligent Touch Controller software versions 6.XX and iTouch Manager software versions 2.XX. This setting allows the discharge air temperature setpoints to be adjusted by the Intelligent Touch Controller/Manager; however the range for this setpoint is restricted to 60-90°F for the Intelligent Touch Controller. On the iTouch Manager, the setpoint is restricted to the range set by the MicroTech unit controller.
 - b. **“USw/oSpt”** – For use with Intelligent Touch Controller software versions 6.XX and iTouch Manager software versions 2.XX. This setting prevents the discharge air temperature setpoint from being adjustable by the Intelligent Touch Controller/Manager but allows, setpoints to be monitored (for applications where the setpoint will be less than 60°F or greater than 90 °F).
 - c. **“Std”** – For use with Intelligent Touch Controller software versions 4.XX and iTouch Manager software versions 1.XX. This setting is allows for the discharge air temperature setpoints to be adjusted within the range set by the MicroTech unit controller.
5. Set the ‘Low Speed =’, ‘Med Speed =’, and ‘High Speed =’ parameters to the percentages the unit’s supply fan will receive when a Low, Med, or High speed command is sent from the Intelligent Touch Controller/Manager. *The speed is set as a percentage of the supply fan’s maximum speed.*
6. Use “Temp Display=” to set a temperature for the Intelligent Touch Controller/Manager to display. This is the temperature that will appear at the top of the side bar when a unit is selected on the iTouch Manager.
7. Navigate to Commission\Cooling Setup
8. Under the Cooling Setup menu, set Cooling Reset to None. *(The setpoint will not be sent to the controller from the DIII network if Cooling Reset is set to Network because the DIII-NET Communication Gateway communicates to the unit controller via MODBUS, rather than a COM module.)*
9. If the iTouch version is set to “USw/Spt,” verify that the “Min Clg Spt” and “Max Clg Spt” are set as desired (under the Cooling Setup menu); as well as the “Min Htg Spt” and “Max Htg Stp” (under the Heating Setup menu). The iTouch Manager will enforce these settings.

Intelligent Touch Controller Configuration

The Intelligent Touch Controller also needs to be configured. This section shows how to change the icon for a zone and how to set the dead band to zero. Refer to the Intelligent Touch controller Manual (ED72-423) for more information on navigating the Intelligent Touch Controller menus. The Intelligent Touch controller Manual is available on www.daikinac.com.

If the iTouch Manager is being used, see the next section “[iTouch Manager Configuration](#)”

Change an Icon on the Intelligent Touch Controller:

1. Select Settings by pressing the “S” button in lower right corner, indicated by the red arrow.

Figure 10, Zone Screen on Intelligent Touch Controller

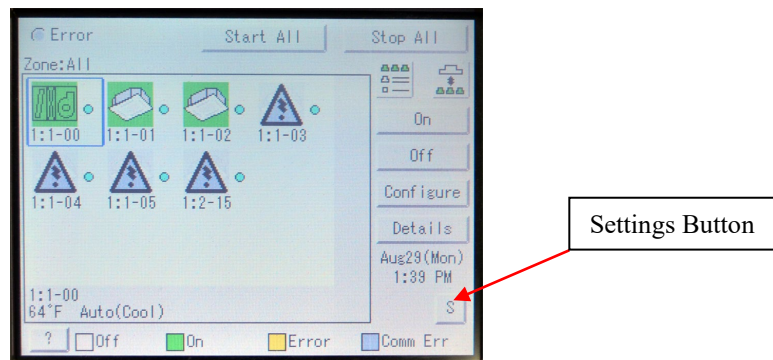

2. In the Settings Menu press the down arrow, select “System” and then press Execute.

Figure 11, System Setting Screen Shot, Intelligent Touch Controller

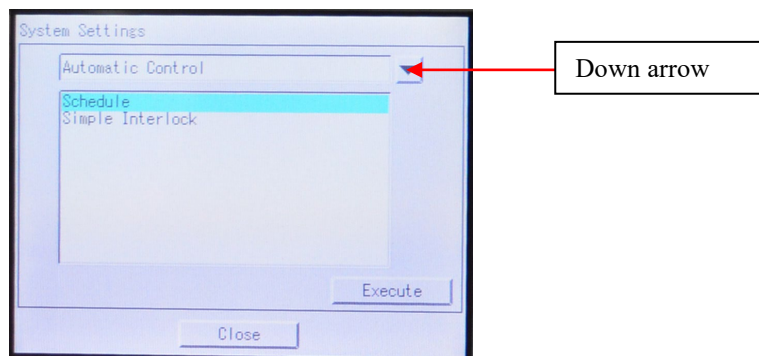

3. When the System menu displays as shown in Figure 12, select “Zone/Group” and then press the Execute button.

Figure 12, Zone/Group Selection Screen, Intelligent Touch Controller

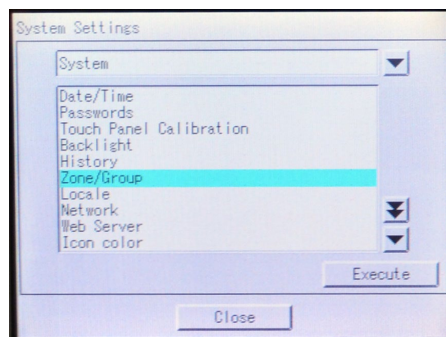

4. In the Zone / Group Settings screen, press the “Settings” button in the “Reg. Groups” box and then OK.

Figure 13, Zone / Group Screen



5. Use the triangular Up and Down arrow buttons to change the icon as desired and then press OK.

Figure 14, Group Settings Screen

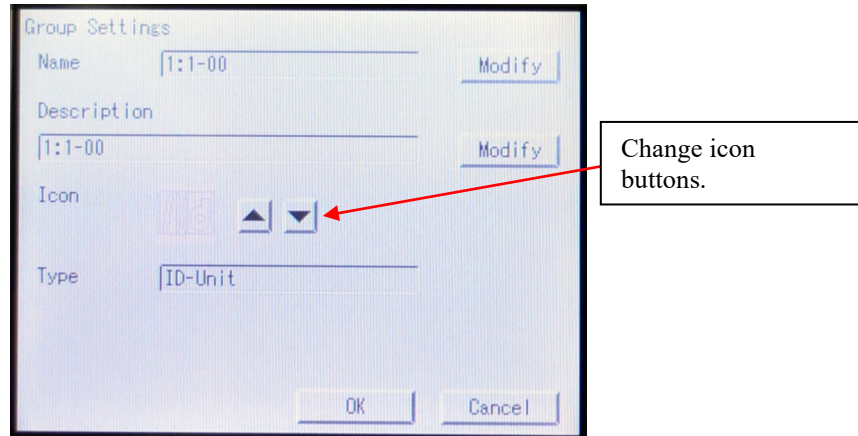

Creating a New Zone and Setting the Intelligent Touch Controller Dead Band

- From the main screen the zone “All” should be highlighted, as in Figure 15. From this screen press the Settings button in the lower right corner, indicated with the red arrow.

Figure 15, All Zones Display on Intelligent Touch Controller

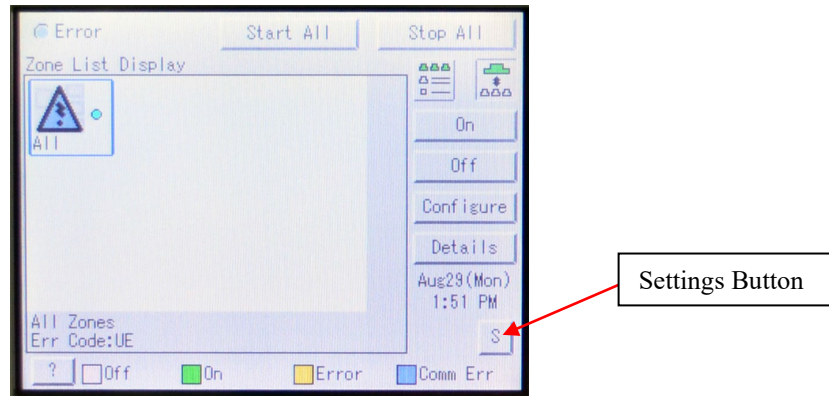

- In the Settings Menu press the down arrow, select “System” and then press Execute.

Figure 16, System Settings Screen

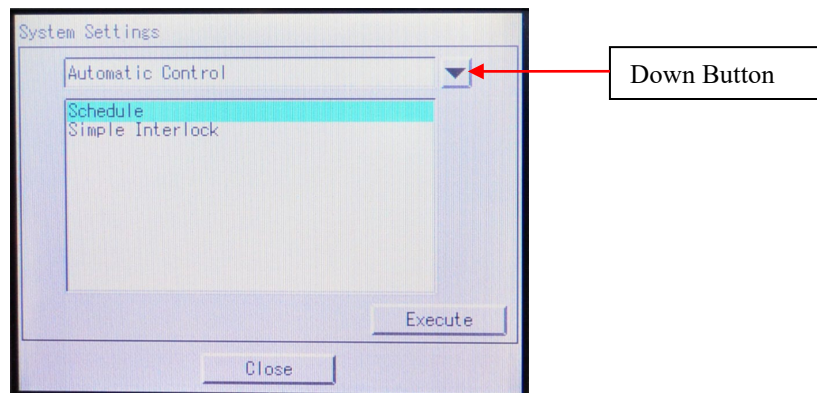

- When the System menu displays as in Figure 17, select “Zone/Group” then press “Execute”.

Figure 17, System Menu for Selecting Zone/Group

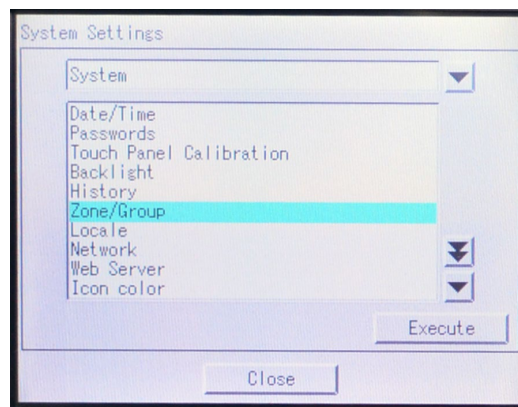

- Make a new zone group populated only by the DIII-NET Communication Gateway as follows:
 - Under the “Zone List” box press the “Add” button and make sure the new zone group is highlighted.
 - Highlight the unit DIII-NET Communication Gateway address from the “Group” box.

- Press the double arrow button to add the unit to that zone.

Figure 18, System Zone Group Screen

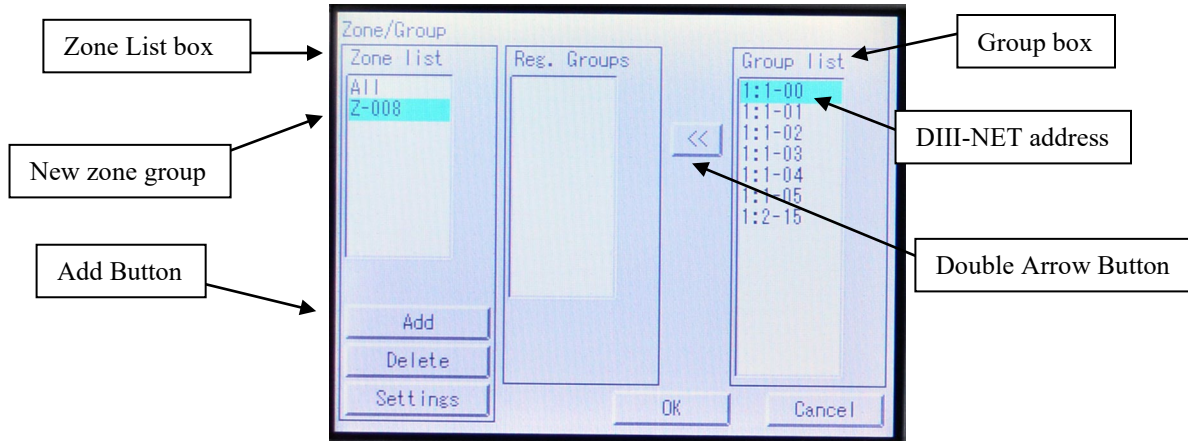

5. Press the “OK” button twice to get back to the main screen. The main screen should look similar to Figure 19 below. Make sure the zone group created in step 4 is highlighted with a blue line around it, and then press the “Configure” button. If it is not highlighted, press to select it.

Figure 19, System Menu for Setting up New Zone

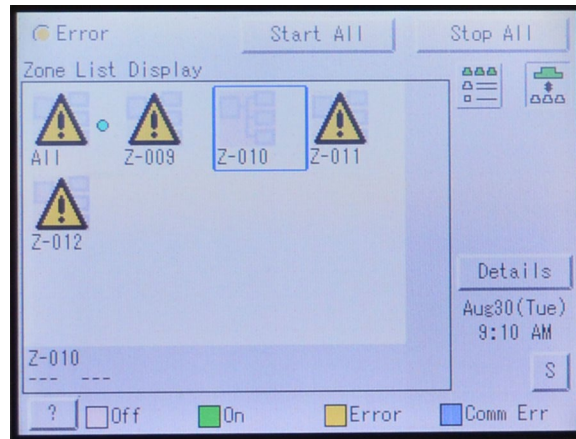

6. From the Configure screen press the “Setpoint Range” button. Then press OK.

Figure 20, Configure Screen for Setting Setpoint Range

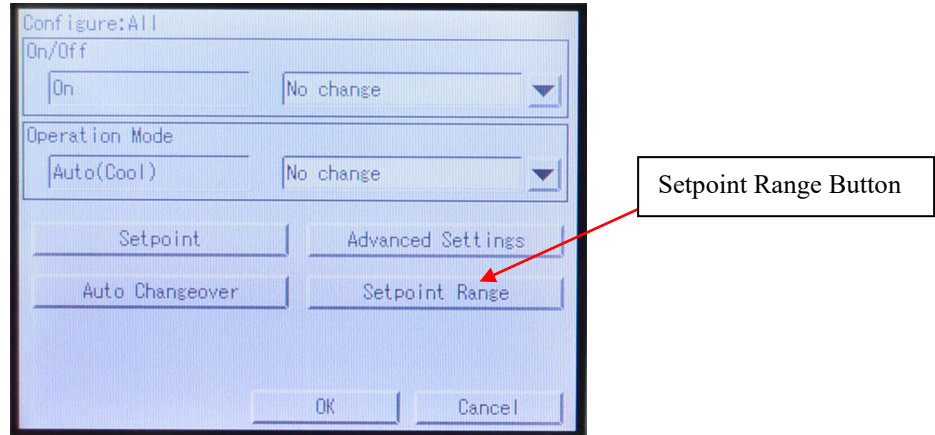

7. From the “Setpoint Range” screen, set “Min Cool/Heat SP Differential” to “0*”.

Figure 21, Setpoint Range Configuration Screen

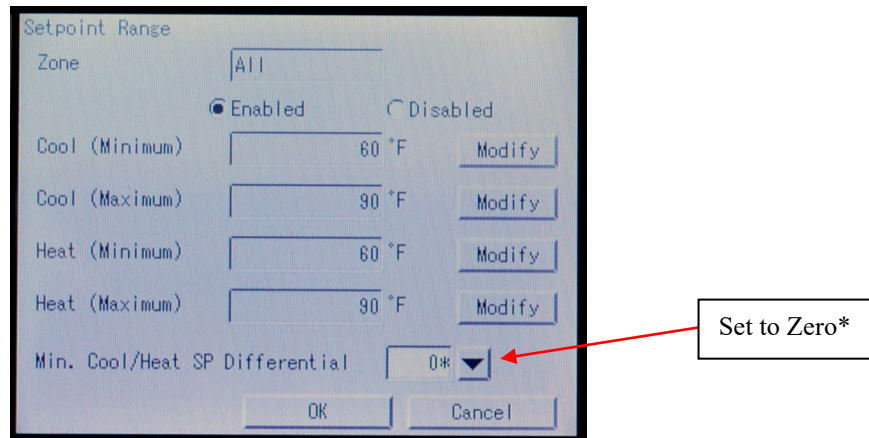

Intelligent Touch Controller Operation

The following section describes basic operation related to the Air Handling unit through the Intelligent Touch Controller interface. Refer to ED72-423 for more information about the operation of the Intelligent Touch Controller, available on www.daikinac.com.

Air Handling Unit Operation

- Figure 22 shows the Air Handling unit running in Occupied mode.

Figure 22, Air Handling Unit in Occupied Mode



- Figure 23 shows the Air Handling unit off in Unoccupied mode.

Figure 23, Air Handler Unit in Unoccupied Mode



- Figure 24 shows the Air Handling unit running in Unoccupied operation (requires optional space sensor, refer to OM 920 for more information, available on www.DaikinApplied.com)

Figure 24, Air Handler in Unoccupied Operation



Adjusting Discharge Air Setpoint

Note: This only applies if 'Std' or 'USw/Spt' is selected for iTouch Version. Refer to DIII-Net Communication Gateway Addressing section for more information.

Note: Discharge air temperature setpoint cannot be adjusted with 'USw/oSpt' selected.

1. Highlight the Air Handling unit and select Configure.

Figure 25, With Air Handling Unit Selected

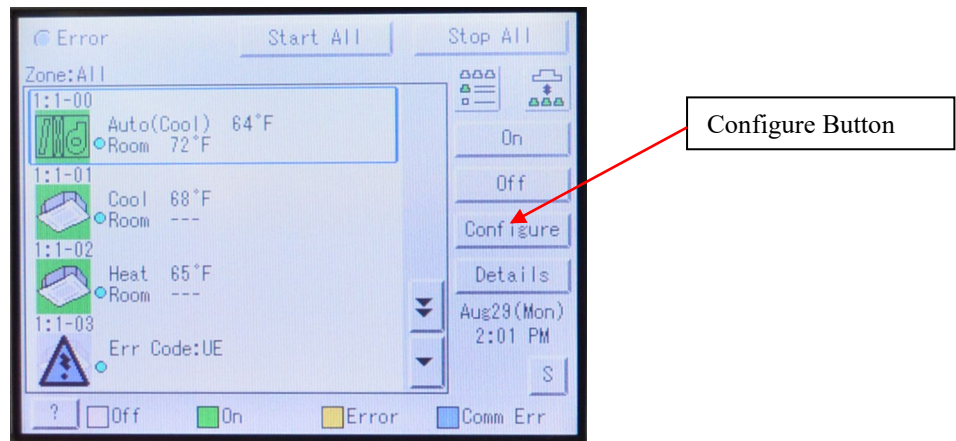

2. For 'Std' select Modify for the setpoint. Change setpoint and press OK.

Figure 26, Configure Screen for Air Handling Unit Std Version

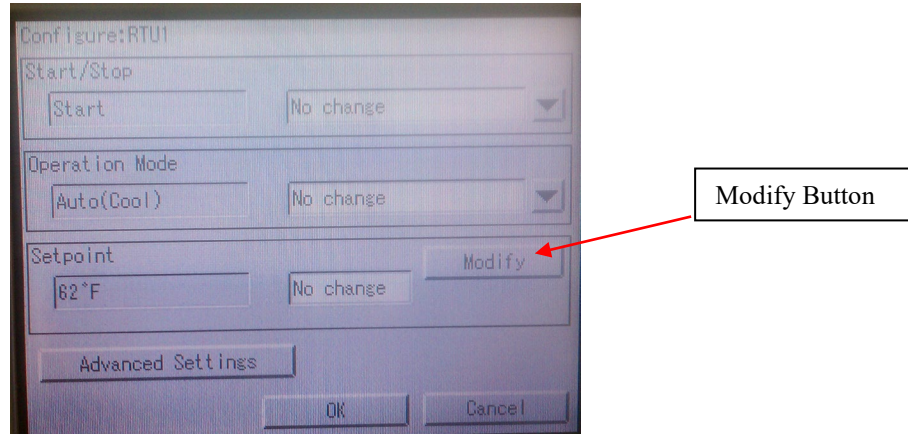

- For 'USw/Spt' versions select Modify for either setpoint.

Figure 27, Configure Screen for Air Handling Unit US Version.

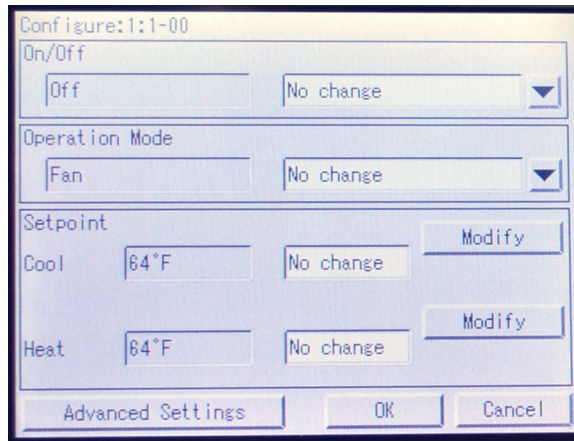

Note: For both versions, modifying the setpoint will adjust the discharge air setpoint for whatever mode the unit is currently in.

Adjusting Fan Speed

Note: This only applies if the Supply Fan Capacity Control flag is set to 'Speed/Net' on the MicroTech unit controller. Refer to OM 920 for more information on this topic.

- Highlight the Air Handling unit and select Configure.

Figure 28, Air Handling Unit Selected.



Configure Button

2. On the Configuration Screen, press the Advanced Settings button.

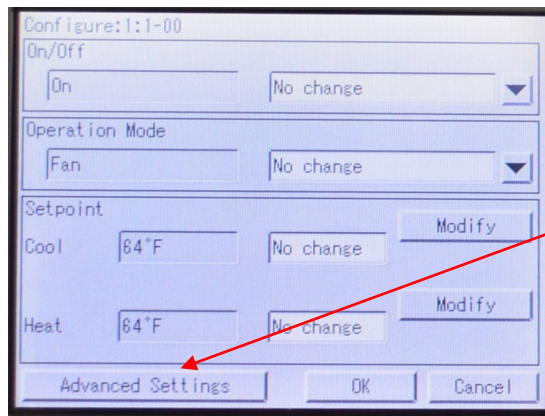

Advanced Settings Button

3. On the Advanced Settings screen, select the desired Fan Speed setting and press OK.

Figure 29, Advanced Settings Configuration Screen

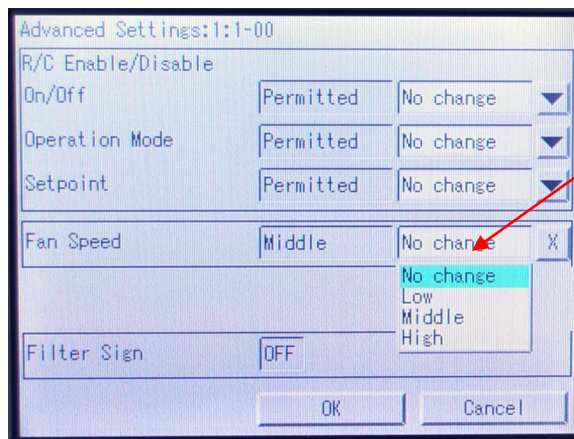

Fan Speed Settings

iTouch Manager Configuration

The iTouch Manager (iTM) also needs to be configured. This section shows how to add units to the iTM, change the icon for a zone and how to set the dead band to zero. Refer to manuals EM11A017 and EM11A022 for more details regarding the operation and commissioning of the iTouch Manager. The iTM manuals are available on www.daikinac.com.

If the Intelligent Touch Controller is being used, see the previous section “[Intelligent Touch Controller Configuration](#)”

Auto Register a Unit to the iTouch Manager

The iTouch Manager will often automatically detect units on a DIII network. However, most Daikin Applied AHUs must be added manually. See the next section, “*Manually Add a Unit to the iTouch Manager.*” To automatically register a unit to the iTouch Manager, proceed with the following steps:

1. Select the “Menu List” button from the bottom of the screen. See Figure 30.

Figure 30, iTouch Manager Home Screen

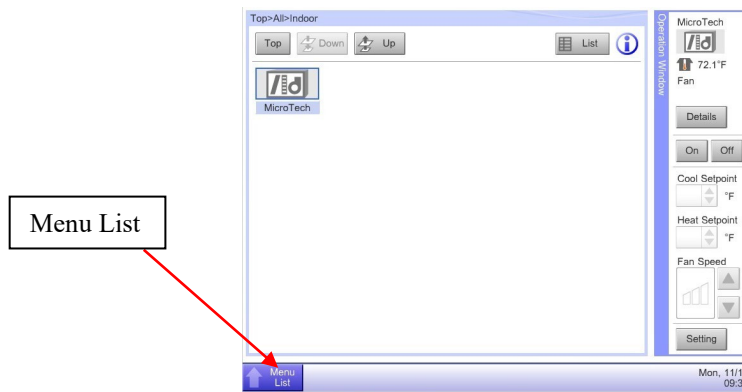

2. From the Menu List Screen, tap the 4 corners of the screen as shown in figure 31 to access the service login.

Figure 31, Accessing Service Login

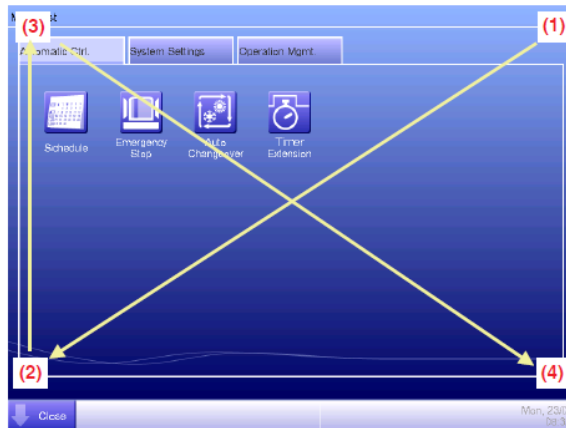

3. Enter the password “daikin” and press OK. See Figure 32.
4. A red frame will appear around the edges of the screen when the service login is active, as seen in figure 33.

Figure 32, Service Login Screen

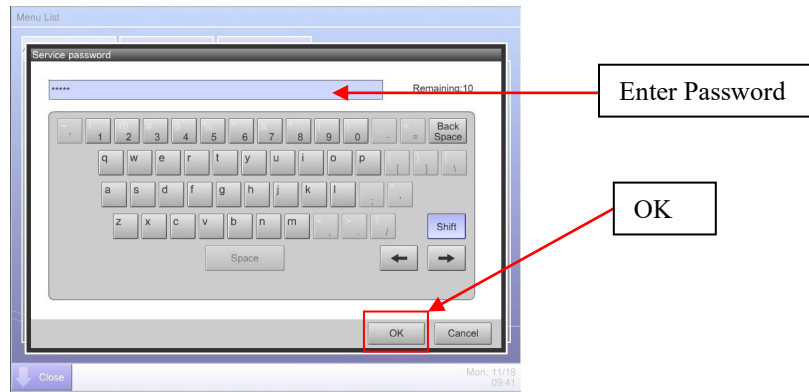
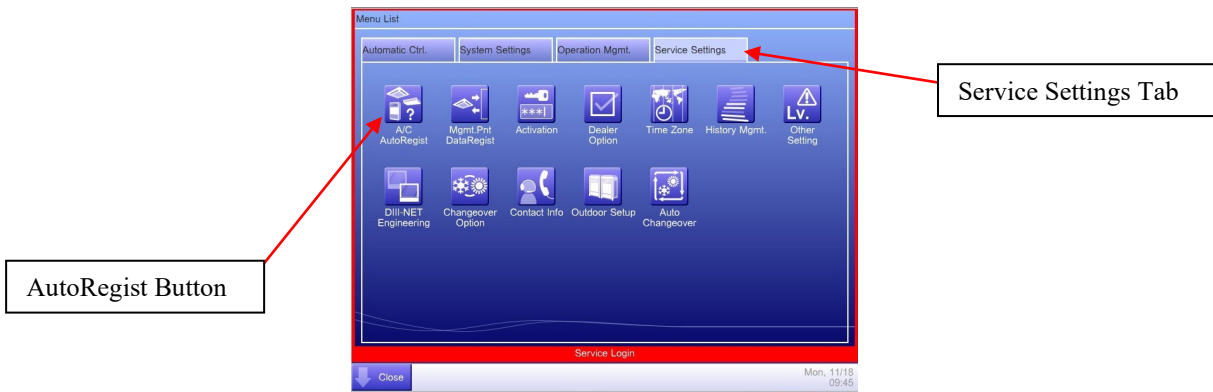
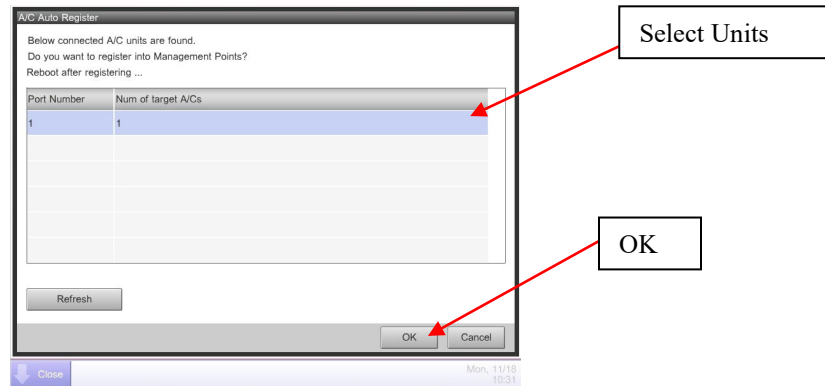

Figure 33, Service Login Menu List – Auto Register



5. Go to the Service Settings Tab and Select “A/C AutoRegister” See Figure 33.
6. Select the units you want to register on the A/C Auto Register Screen and press “OK.” See Figure 34. If no units are available to select, the unit(s) may have to be added manually. See the next section, “Manually Add a Unit to the iTouch Manager,” for more information.

Figure 34, Auto Register Screen



7. When prompted to confirm the changes, select OK. See Figure 35. The iTM will immediately shutdown after confirmation. After it has automatically rebooted, the unit(s) should be registered.

Figure 35, Confirm Auto Register Changes

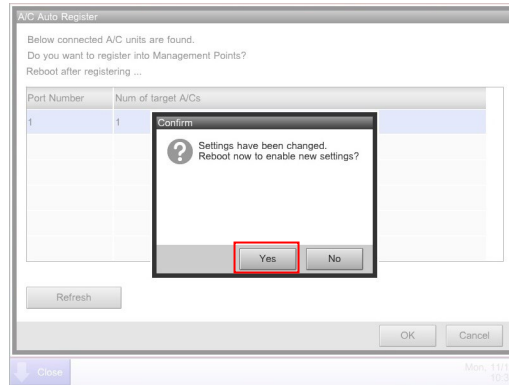

Manually Add a Unit to the iTouch Manager

Most Daikin Applied AHUs are not recognized by the iTM’s Auto Register feature. Because of this, it is often necessary to register a unit to the iTouch Manager manually. To manually add a unit to the iTM:

1. Select the “Menu List” button from the bottom of the home screen. See Figure 30.
2. From the Menu List Screen, tap the 4 corners of the screen to access the service login. See Figure 31.
3. Enter the password “daikin” and press OK. See Figure 32.
4. A red frame will appear around the edges of the screen when the service login is active, as seen in Figure 36.
5. Go to the Service Settings Tab and Select “Mgmt.Pnt DataRegist” See Figure 36.

Figure 36, Service Login Menu List – Manually Register

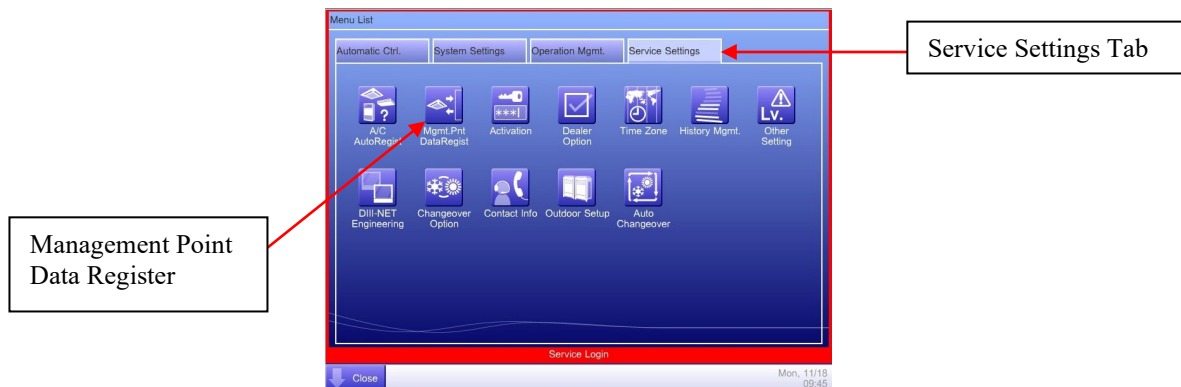

6. Select Add Unit at the bottom of the Management Point Data Register Menu. See Figure 37.
7. Select Indoor under Management Point Type Menu. See Figure 38.

Note: AHUs must be registered as indoor units when manually added to be properly recognized by the iTouch Manager.

Figure 37, Add Management Point to iTouch Manager

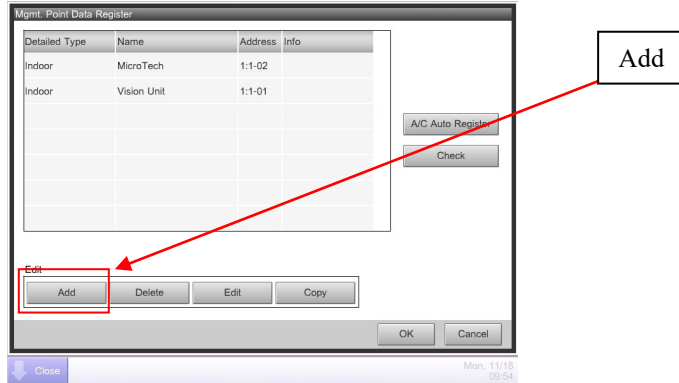
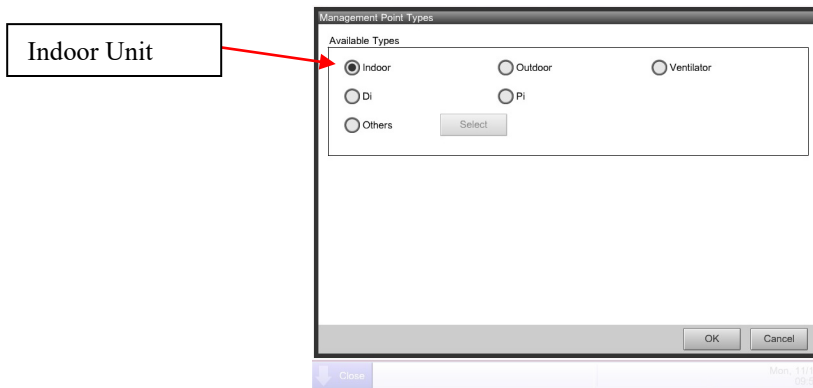

Figure 38, Management Point Type



8. Under the Management Point Attributes Menu, set the DIII address using the drop-down menus. See Figures 39 and 40. This address must match the DIII board's address as previously set by the MicroTech Unit Controller. See section [“DIII-NET Communication Gateway Addressing”](#) steps 5-7.
9. Set the name of the unit by clicking “Modify” next to “Name.” See Figure 39. When the keyboard comes up, enter a name for the unit and press OK. See Figure 41. *Names are limited to 12 characters.*

Figure 39, Setting Unit Address and Name

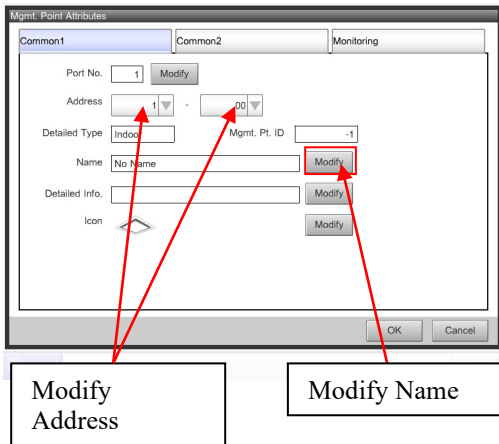

Figure 40, DIII Address Drop-down Menu

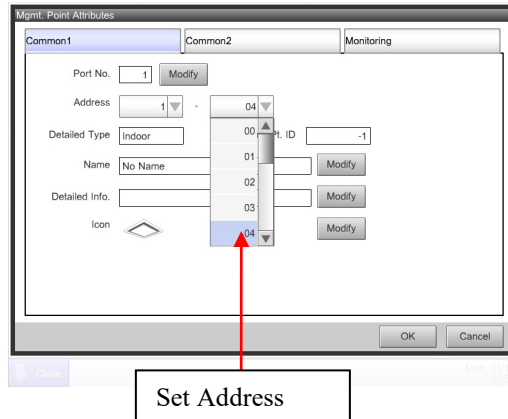
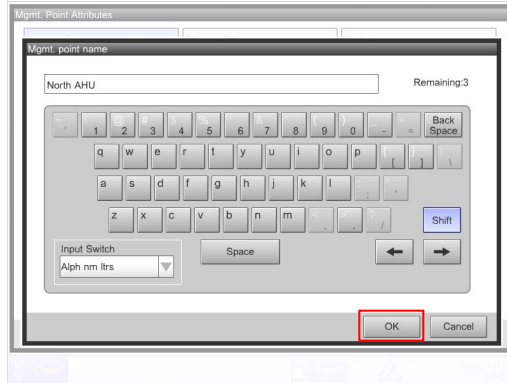
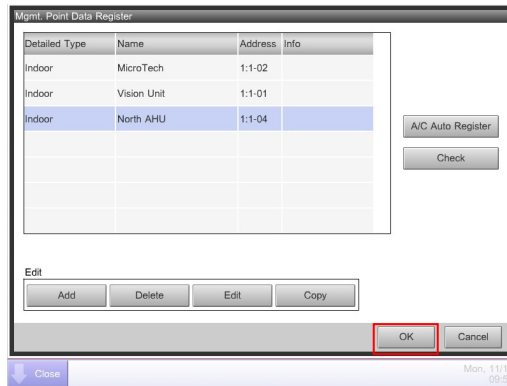

Figure 41, Setting Unit Name



10. After the unit's address and name have been set, press OK. The unit should now appear on the Management Point Data Register Menu. See Figure 42.
11. Select OK to register the unit. See Figure 42.

Figure 42, New Management Point on iTouch Manager



12. When prompted to confirm the changes, select OK. See Figure 43. The iTM will immediately shutdown after confirmation. After it has automatically rebooted, the unit should be registered.

Figure 43, Confirm Register Data Point

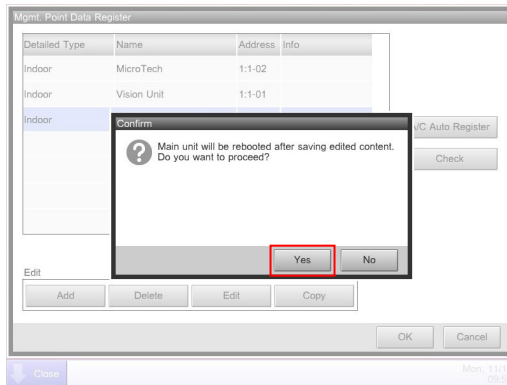

Changing Icon and Description on iTouch Manager

1. Select Menu List from the home screen. See Figure 30.
2. From the Menu List Screen, tap the 4 corners of the screen as shown in Figure 31 to access the service login.
3. Enter the password “daikin” and press OK. See Figure 32.
4. A red frame will appear around the edges of the screen when the service login is active. See Figure 36.
5. Go to the Service Settings Tab and Select “Mgmt.Pnt DataRegist” See Figure 36.
6. Select the unit to be changed and choose “Edit.” See. Figure 44.

Figure 44, Unit Selected for Editing

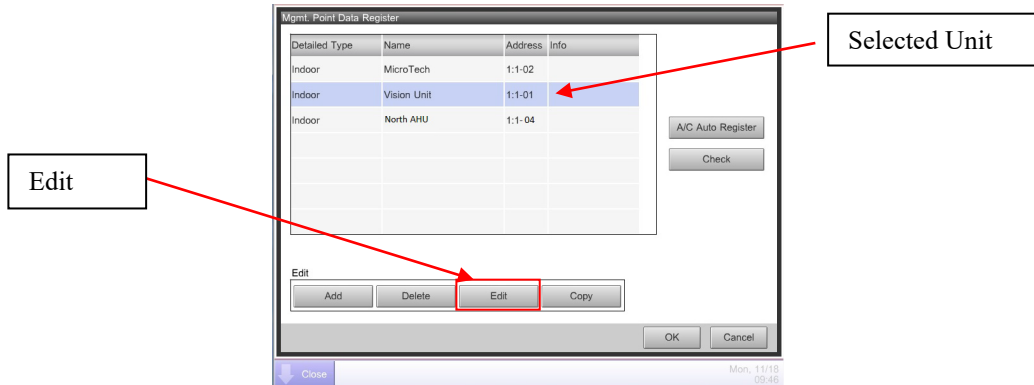

7. To add detailed info about the unit, select Modify next to “Detailed Info.” See. Figure 45.

Figure 45, Editing Unit Information

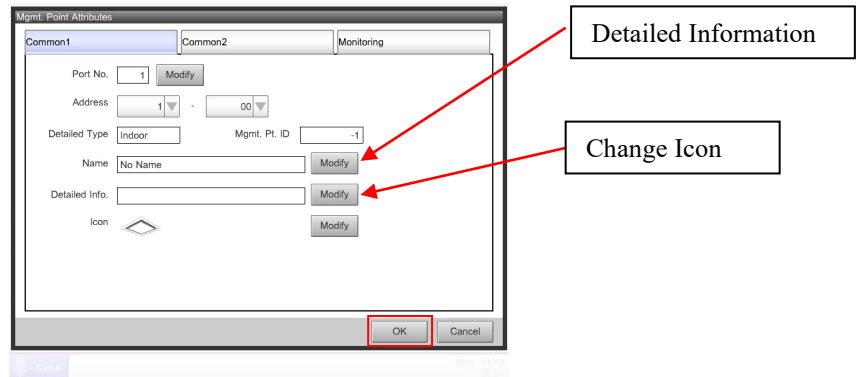

8. Enter the information on the keyboard that pops up and press OK. See Figure 46.

Figure 46, Entering Detailed Information

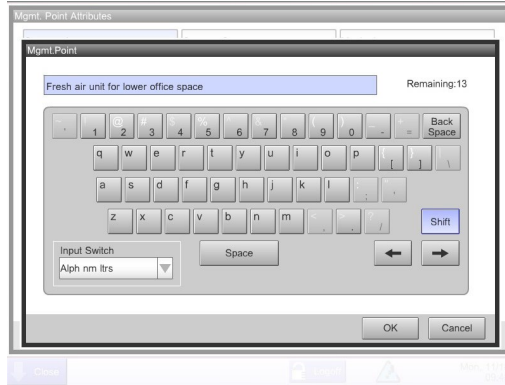

9. To change the unit's icon, select Modify next to "Icon" See Figure 45.
10. A list of icons will appear as shown in Figure 47. Select the desired icon and press OK.
11. Select OK to exit menu.

Figure 47, Icon Selection

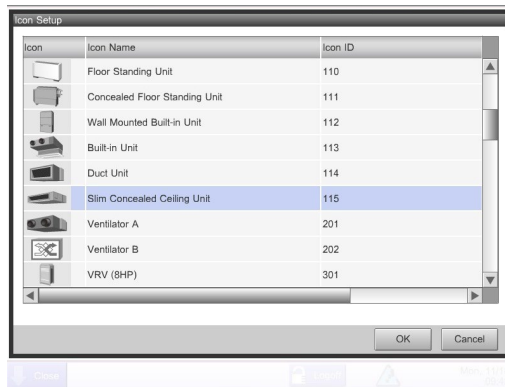

12. When prompted to confirm the changes, select OK. The iTM will save the changes and shutdown. When the iTM has rebooted the changes will have been applied. See Figure 43.

iTouch Manager Operation

This section describes the operation of the iTouch Manager to monitor and control Daikin Applied Air Handler Units. Refer to EM11A017 for more information about the operation of the iTouch Manager, available on www.daikinac.com.

If the Intelligent Touch Controller is being used, see section “[Intelligent Touch Controller Operation](#)”

Turning a Unit On and Off

The iTouch Manager allows units to be easily turned on and off directly from the device list screen.

1. To access the indoor device list, select “All” from the home screen and press down.
2. Select “Indoor” and press down.
3. Select the unit to be changed and choose “On” or “Off” from the sidebar. See Figure 48.

Figure 48, Turning Unit On and Off

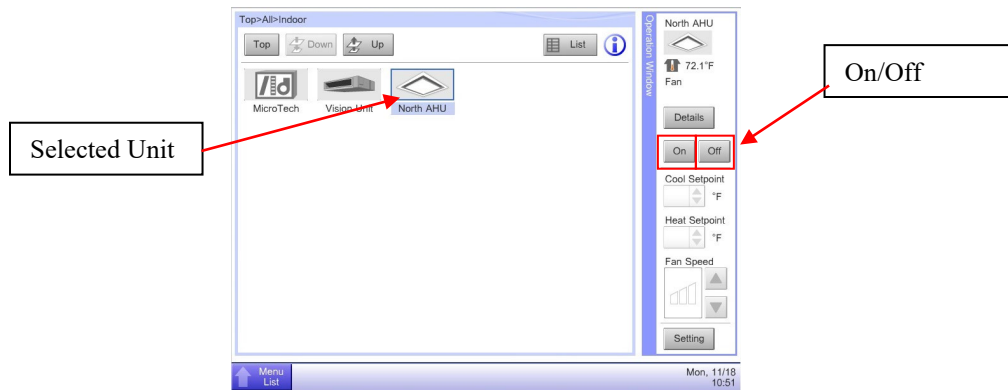

4. When prompted, confirm change. See Figures 49. Unit should start/stop within a minute but usually responds in a few seconds.

Figure 49, Confirm Start/Stop Unit

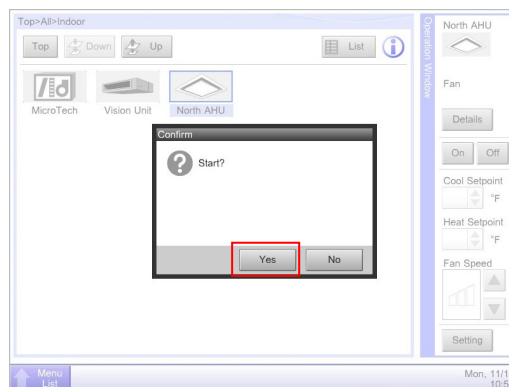

Adjusting Setpoints

Note: This only applies if 'Std' or 'USw/Spt' is selected for iTouch Version. Refer to DIII-Net Communication Gateway Addressing section for more information. *The discharge air temperature setpoint cannot be adjusted with 'USw/oSpt' selected.*

The iTouch Manager adjusts the active setpoint of an AHU. If the unit is in cooling mode, the iTM will adjust the cooling setpoint, if the unit is in heating mode the heating setpoint will be adjusted. If the control temperature is satisfied within the unit's deadband, the unit will switch to Fan Only mode and the setpoints cannot be adjusted.

1. Access the Indoor Devices list. See previous section, "Turning a Unit on and Off" steps 1 and 2.
2. Press "Cool Setpoint" or "Heat Setpoint." See Figure 50. The setpoint adjusted will be the active setpoint, regardless of whether "Cool Setpoint" or "Heat Setpoint" is selected.

Figure 50, Adjusting Setpoints from the iTouch Manager

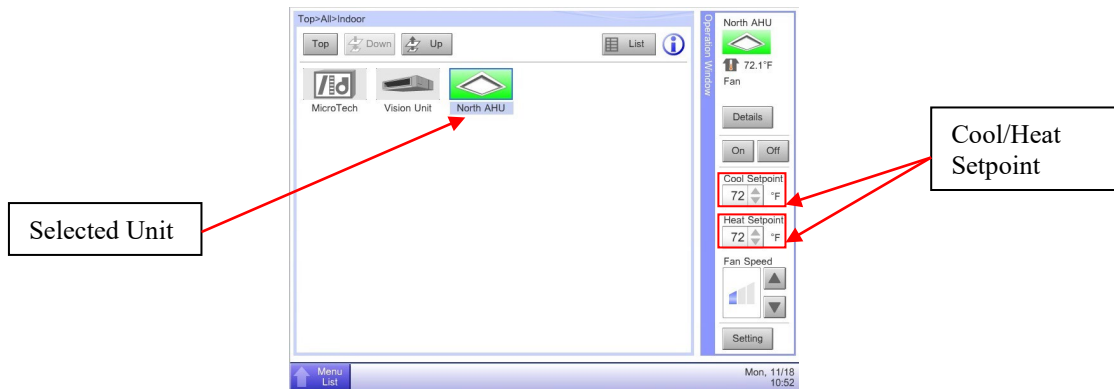

3. Select the desired setpoint. The other setpoint should change to match the previously adjusted setpoint in a couple minutes.

Changing Fan Speed

Note: The Fan Speed can only be adjusted if a variable frequency drive (VFD) is being used. If the Supply Air Fan (SAF) control is set to Constant Air Volume (CAV), this feature will be disabled.

The iTouch Manager gives user the ability to adjust the fan speed of a unit to High, Medium or Low. To set the high, med and low speeds as a percentage of the Supply Fan's maximum speed, see section "[Configuring the DIII Board Using the MicroTech Unit Controller Keypad and Display](#)" Refer to manual OM 920 (available at www.DaikinApplied.com) for more information about MicroTech unit controller operation.

1. Access the Indoor Devices list. See section "Turning a Unit On and Off" steps 1 and 2.
2. Select the Unit to be adjusted.
3. Use the up and down arrows next to the Fan Speed icon to change the fan speed. See Figure 51.

Figure 51, Adjusting Fan Speed from the iTouch Manager

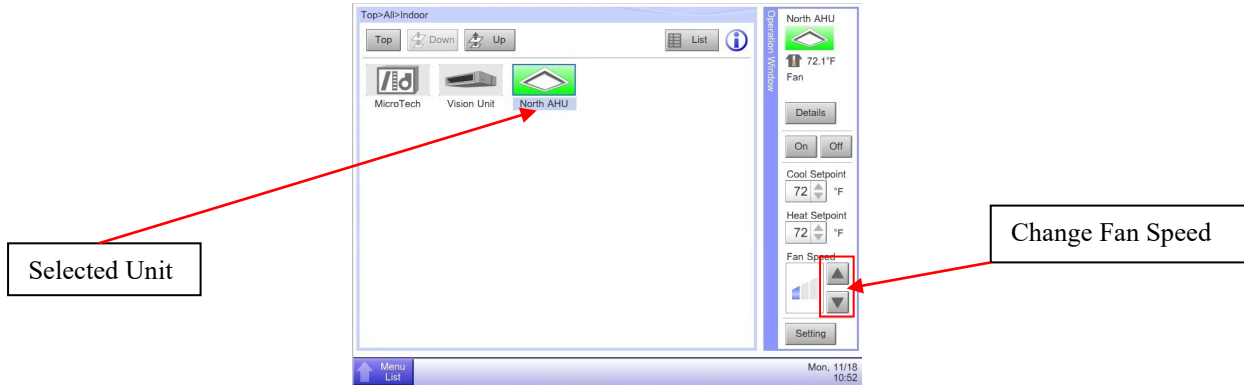

Advanced Settings

The Detailed Setup screen allows multiple changes to be made to a unit at once. As well as containing standard controls such as On/Off and Setpoints, this screen also has several advanced settings.

Main Tab – Unit Settings

1. Access the Indoor Devices list. See section “Turning a Unit On and Off” steps 1 and 2.
2. Select the unit to be modified and press “Settings” at the bottom of the sidebar. See Figure 52.

Figure 52, Accessing Detailed Settings

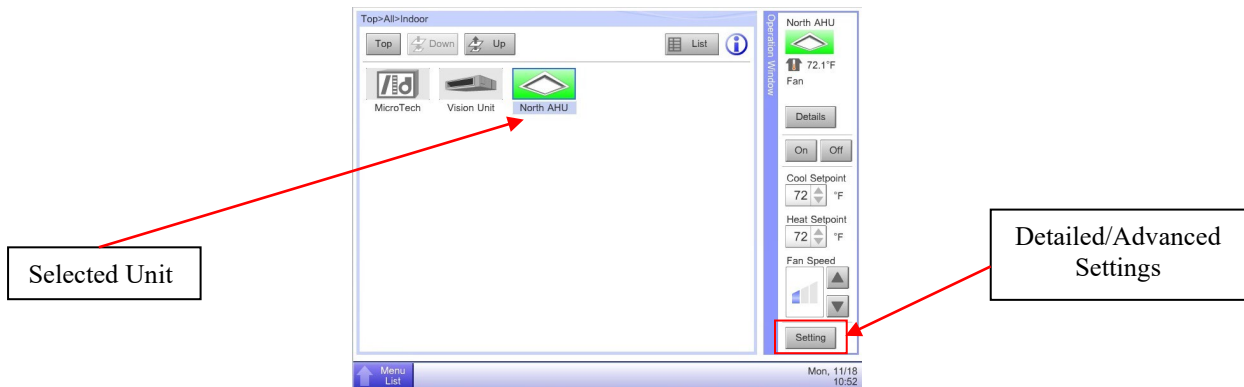

3. Changes can be made to the unit in the Detailed Settings screen. See Figure 53. Adjustable parameters include:
 - a. On/Off – Turn unit on or off
 - b. Operation Mode – Has no effect on Daikin Applied AHUs.
 - c. Setback Setpoint – Sets unoccupied setpoints for certain types of units. Has no effect on Daikin Applied AHUs.
 - d. Cool Setpoint – modifies active setpoint. See section “[Adjusting Setpoints](#)”
 - e. Heat Setpoint – modifies active setpoint. See section “[Adjusting Setpoints](#)”
 - f. Min. Cool/Heat SP Differential – Sets the minimum difference between Cool and Heat Setpoints. Because both parameters control the active setpoint on an AHU, this differential should be set to zero.
 - g. Setpoint Tracking Mode – determines whether the iTM tracks changes to the setpoints.
4. Select the checkbox next to an item to change its value. *Checkboxes must remain checked to apply changes.*

Figure 53, Detailed Settings Screen

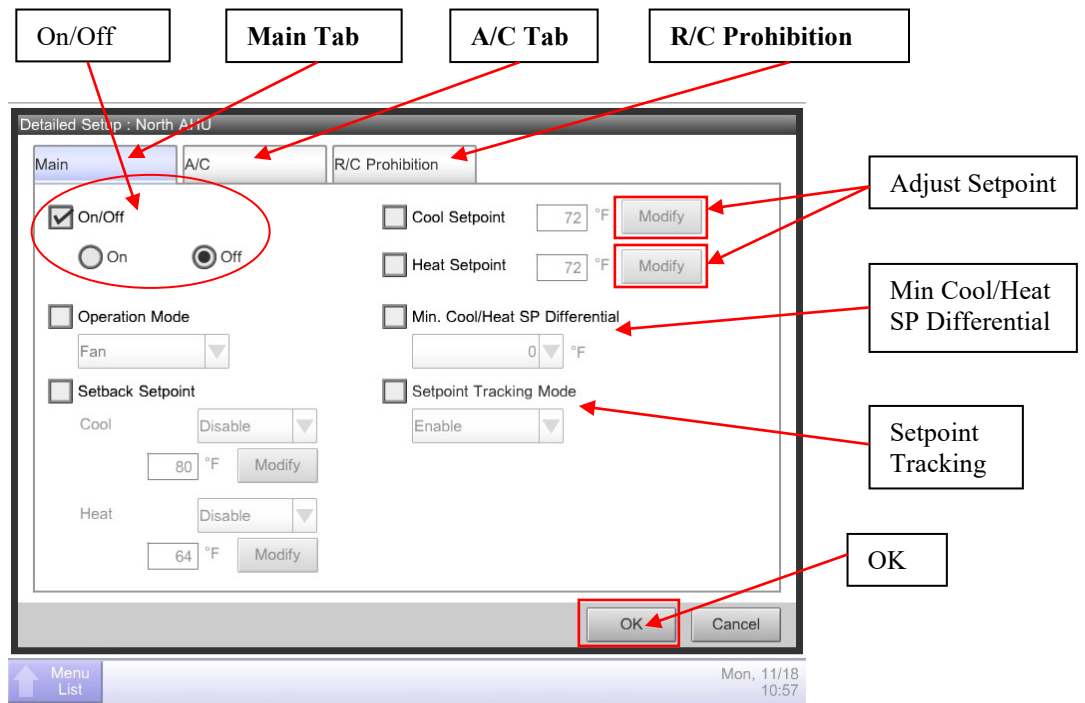

5. Press OK to save changes.
6. When prompted, confirm unit setup. Changes will be sent to the unit controller.

A/C Tab – Setpoint Restrictions

1. Select the A/C tab from the Detailed Settings screen. See Figure 53.
2. Select the checkbox next to “Setpoint Restriction.”
3. If it is preferred to use the setpoint restrictions from MicroTech unit controller, Select “Disable” under Cooling Limit and Heating Limit. Select “Enable” to restrict setpoints from the iTouch Manager. *Some setpoint restrictions will always be enforced, see note at the end of this section.*
4. Modify the Min and Max setpoint values for Cooling and Heating. See Figure 54.

Figure 54, Setpoint Restrictions

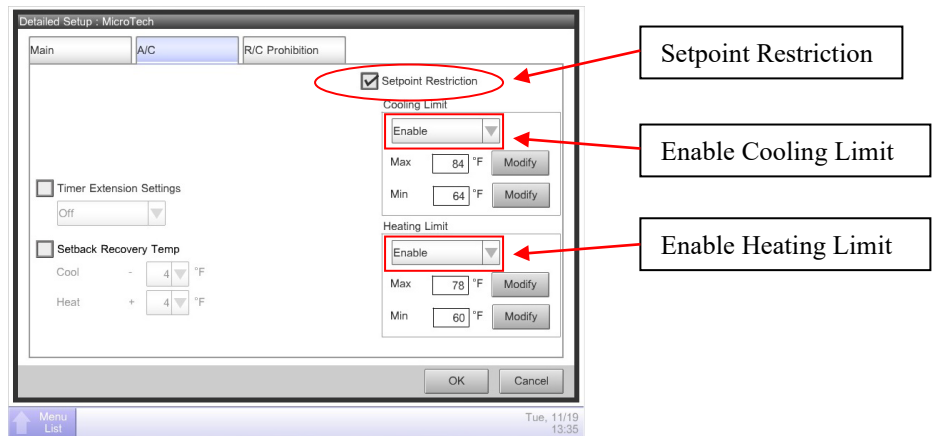

5. Press OK to save changes.
6. When prompted, confirm unit setup. Changes will be sent to the unit controller.

Note: The MicroTech unit controller's internal setpoint restrictions will always be enforced, regardless of iTouch Manager's settings. Enabling setpoint restrictions in the iTouch Manager imposes additional restrictions on the range of setpoints that can be sent to the unit controller for more precise management over the space temperatures and energy savings.

R/C Prohibition Tab

The iTouch Manager can enforce restrictions on changing setpoints and unit operation. To restrict which operations can be changed remotely or from the iTM's Device List screen:

1. Select the R/C Prohibition tab from the Detailed Settings screen.
2. Select the checkbox(s) next to the operations to be restricted.
3. Selected "Permitted" or "Prohibited"
4. Press OK to save changes.
5. When prompted, confirm unit setup. Changes will be sent to the unit controller.

Service Information

Test Procedures

If you can control the unit from its keypad, but you are not able to communicate with unit via the DIII network, follows these steps:

- Check the network wiring.
- Check the network parameters and verify that they are correct, and that there are no duplicate devices on the network. (*Addresses must be unique.*) See section “[DIII Communication Gateway Addressing](#)”
- Verify that the MicroTech unit controller is setup correctly. See section “[Configuring the DIII Board and MicroTech Unit Controller](#).”
- If the DIII-NET Communication Gateway still does not respond, contact the Daikin Applied Controls Customer Support Group at 866-462-7829.

Parts List

Replacement Communication Board

Description	Part Number
DIII-NET Communication Gateway	250800301

Field Install Kit

Description	Part Number
DIII-NET Communication Gateway Installation Kit	250800501
<i>Kit Includes the following:</i>	
<i>DIII-NET Communication Gateway</i>	<i>250800301</i>
<i>Mounting Plate</i>	<i>193477501</i>
<i>(4) Circuit Board Standoffs</i>	<i>048166705</i>
<i>Wire Harness</i>	<i>193581501</i>
<i>120/24VAC Transformer, 50VA</i>	<i>349947203</i>

Appendix A

Alarms

When an alarm is triggered, it will appear on both the MicroTech unit and the Intelligent Touch Controller. Below is a list of alarms and their corresponding level, number, code and description.

Level	Alarm #	D3 Alarm Code	Description
	0	0	No active alarm
Warning	24	---	Dirty filter
Warning	28	13	Air flow switch(see 208, D3 don't have the alarm code for switch)
Warning	32	9J	Conductivity
Problem	106/111	J3	Discharge line refrigerant temperature 3 / 1 Sensor
Problem	107	E6	Standard comp3 error
Problem	114	L0	INV comp Error(comp alarm data over the ACS)
Problem	119	J6	Temperature sensor for defrost
Problem	121	J5	Suction line refrigerant temperature Sensor
Problem	124	F3	High discharge refrigerant temperature
Problem	126	E9	Exp valve
Problem	128	E7	OA fan
Problem	130	U0	Lo refrigerant charge
Problem	132	JC	Pressure Transducer Suction Line Sensor
Problem	134	JA	Pressure Transducer Discharge Line Sensor
Problem	135	UJ	Modbus Communication Error
Problem	136	79	Lo pressure difference
Problem	137	7J	Water flow
Problem	140	41	Water regulating valve
Problem	152-159	FC	Lo pressure 1 - 8
Problem	160-167	FA	High pressure 1 - 8
Problem	169	EE	Sump water level
Problem	179	C4	Entering fan temperature/Leaving coil temperature sensor
Problem	182	34	Return air sensor Error
Problem	185	CJ	Space sensor error
Problem	188	H9	Outdoor air temperature Sensor
Problem	191	80	Entering water temperature sensor
Problem	194	C4	Mixed air(RTU/OAT) temperature sensor
Problem	197	89	Freeze
Problem	199	10	Heat Fail
Fault	208	13	Air flow
Fault	212	CA	Lo discharge air temperature
Fault	216	CA	High discharge air temperature
Fault	220	C9	High return air temperature
Fault	224	6A	Duct High pressure Limit
Fault	228	CA	Discharge air sensor
Fault	244	H1	Control temperature sensor error
Fault	250	E0	Emergency stop
Fault	252	89	Freeze

Appendix B

Configurable Parameters

Table 4 defines the different parameters that are available in the D3 Set Up menu. The default values and acceptable ranges of values are also included.

Table 2 DIII Set-Up Menu

Menu Item	Description	Default	Range
ItouchVer	Sets the Version of Intelligent Touch Controller software	std	'Std' / 'USw/Stp' / 'USw/oStp'
Unit D3 Addr	Particular address for unit	N/A	1-00 - 8-15
Set D3 Addr	Saves particular DIII address	No	Yes / No (reverts back to no)
Temp Display	Selects which temperature to display	DAT	None, DAT, Space, RAT, OAT

This is a list of the menu items in the DIII Status Menu on the MicroTech unit controller. Also listed is a description of the item, its default value, range of values or enumerations, if it can be read or written to, and which controller can change the value of the parameter. Most of the DIII Status Menu items read in values from the Intelligent Touch Controller and display them on the MicroTech unit controller. Not all menu items will always be shown on the MicroTech unit controller. There are items that will not show unless other parameters are set to a specific value. Refer to the OM 920 for more information.

Table 3 DIII Status Menu

Menu Items	Description	Default	Range	R / W
D3 Com Sts	Displays status of D3 Gateway	OK	OK, Error	Read
D3 Addr Err	Displays address error	OK	OK, Error	Read
D3 On/Off	Displays D3 on or off	On	On, Off	Read
D3 Mode	Displays D3 mode	Auto	Auto, Cooling, Heating, Fan	Read
D3 Clg Spt	Displays cooling set point	N/A	0 - 100°F	Read
D3 Htg Spt	Displays heating set point	N/A	0 - 120°F	Read
D3 SAF Spd	Displays fan speed parameter	N/A	Low, Med, High	Read
D3 Min Load	Displays max load to enable economizer	20%	0 - 100%	Read
D3 Max Load	Displays min load to enable economizer	50%	0 - 100%	Read
D3 Eco Ena	Displays if Economizer is enabled	N/A	(Disabled, Enabled)	Read
D3 SWVersion	Displays software version	N/A	N/A	Read
OAAAdd1-16	Displays valid Air-Net address	N/A	0 - 16	Read
OAAAdd17-32	Displays valid Air-Net address	N/A	17 - 32	Read
OAAAdd33-49	Displays valid Air-Net address	N/A	33 - 49	Read
OAAAdd49-64	Displays valid Air-Net address	N/A	49 - 64	Read
SelectOAAAddr	Selects OA unit address to displays setup for	N/A	0 - 64	R / W
CurrOAAAddr	Displays current OA address selected	N/A	0 - 64	Read



Daikin Applied Training and Development

Now that you have made an investment in modern, efficient Daikin Applied equipment, its care should be a high priority. For training information on all Daikin Applied HVAC products, please visit us at www.DaikinApplied.com and click on Training, or call 540-248-9646 and ask for the Training Department.

Warranty

All Daikin Applied equipment is sold pursuant to its standard terms and conditions of sale, including Limited Product Warranty. Consult your local Daikin Applied Representative for warranty details. To find your local Daikin Applied Representative, go to www.DaikinApplied.com.

Aftermarket Services

To find your local parts office, visit www.DaikinApplied.com or call 800-37PARTS (800-377-2787).

To find your local service office, visit www.DaikinApplied.com or call 800-432-1342.

This document contains the most current product information as of this printing. For the most up-to-date product information, please go to www.DaikinApplied.com.

Products manufactured in an ISO Certified Facility.