



Installation and Maintenance Manual

IM 918-5

Group: Controls

Part Number: IM 918

Date: June 2023

LONWORKS® Communication Module MicroTech Unit Controllers

Commercial Packaged Rooftops, Applied Rooftop, and Self-Contained Systems

Models: DPH, DPS, DPSA/DFSA, MPS, RAH, RCE, RCS, RDE, RDS, RDT,
RFS, RPE, RPS, SWP and SWT



Table of Contents

Introduction	3
Hazardous Information Messages	3
Reference Documents	3
Product Information	4
Description	4
Application	4
Physical Dimensions	4
Specifications	4
Component Data	5
Installation and Mounting	7
Field Installation Kit	7
Installing a new Communication Module	7
Replacing a Communication Module	8
Commissioning and Configuration	9
LONWORKS Network Addressing	9
Commissioning	9
Configuration	10
Service Information	12
Troubleshooting	12
Parts	12
Technical Support	12
Revision History	13

©2023 Daikin Applied, Minneapolis, MN. All rights reserved throughout the world. This document contains the most current product information as of this printing. Daikin Applied Americas Inc. has the right to change the information, design, and construction of the product represented within the document without prior notice. For the most up-to-date product information, please go to www.DaikinApplied.com.

TM MicroTech, Rebel, Maverick II and Daikin Applied are trademarks or registered trademarks of Daikin Applied Americas Inc. The following are trademarks or registered trademarks of their respective companies: Echelon, LonWorks, LonMark, and LonTalk from Echelon Corporation; Modbus from Schneider Electric; and Windows from Microsoft Corporation.



Introduction

This manual provides instructions for installing or replacing the LONWORKS® communication module used on MicroTech® III and MicroTech 4 unit controller applications. It applies to Daikin Applied® Packaged Rooftops, Rebel® Rooftops, and Self-Contained models: DPH, DPS, DPSA/DFSA, MPS, RAH, RCE, RCS, RDE, RDS, RDT, RFS, RPE, RPS, SWP and SWT.

The manual describes how to set up the unit controller for network communication and troubleshoot common network issues.

This document is intended for service technicians or other qualified personnel familiar with standard BACnet concepts and terminology. For technical support, contact the Daikin Applied Controls Support Group at 866-462-7829.

Hazardous Information Messages

DANGER
Danger indicates a hazardous situation, which will result in death or serious injury if not avoided.
 WARNING
Warning indicates a potentially hazardous situations, which can result in property damage, personal injury, or death if not avoided.
 CAUTION
Caution indicates a potentially hazardous situations, which can result in minor injury or equipment damage if not avoided.
NOTICE
Notice indicates practices not related to physical injury.

Reference Documents

Number	Company	Title	Source
078-0156-01G	Echelon® Corporation	LONWORKS FTT-10A Free Topology Transceiver Users Guide	www.echelon.com
078-0120-01E	LONMARK Interoperability Association	LONMARK Application Layer Interoperability Guidelines, Version 3.4	www.lonmark.org
078-0014-01E	LONMARK® Interoperability Association	LONMARK Layers 1-6 Interoperability Guidelines, Version 3.4	
8500_20	LONMARK Interoperability Association	Space Comfort Controller Functional Profile	
8610_10	LONMARK Interoperability Association	Discharge Air Controller Functional Profile	
OM 1288	Daikin Applied	MicroTech 4 Unit Controller Operation Manual	www.DaikinApplied.com
OM 920	Daikin Applied	MicroTech Unit Controller Operation Manual for Applied Rooftop and Self-Contained Systems	
ED 19117	Daikin Applied	MicroTech 4 Unit Controller Network Integration Guide, BACnet and LONWORKS Networks	
ED 15112	Daikin Applied	MicroTech Rooftop and Self Contained Unit Controller Network Integration Guide, BACnet and LONWORKS Networks	

Product Information

Description

The LONWORKS communication module is a printed circuit board within a plastic enclosure. It connects directly to the left side of the unit controller (Figure 3). The software application translates Standard Network Variable Types (SNVTs) and Standard Network Configuration Parameter Types (SCPTs) supported by the unit controller into network variables and parameters used by the LONWORKS network.

Application

A LONWORKS communication module connects the unit controller to the building automation system (BAS) on a LONWORKS network. It enables the exchange of variables between the unit controller and the network.

The LONWORKS communication module is LonMark® 3.4 certified with conformance to the LonMark SCC or DAC functional profile. Profiles are interpreted in the firmware.

Refer to MicroTech 4 Rebel Applied Unit Controller Operation Manual (OM 1288) or MicroTech Applied Air Handling Unit Controller Operation Manual (OM 920) for unit controller display menu options for network variables.

Physical Dimensions

Figure 1: LONWORKS Communication Module Top View

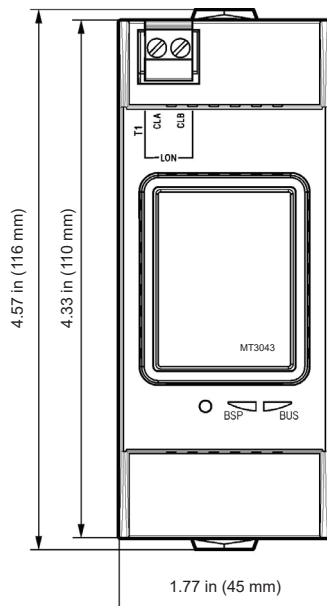
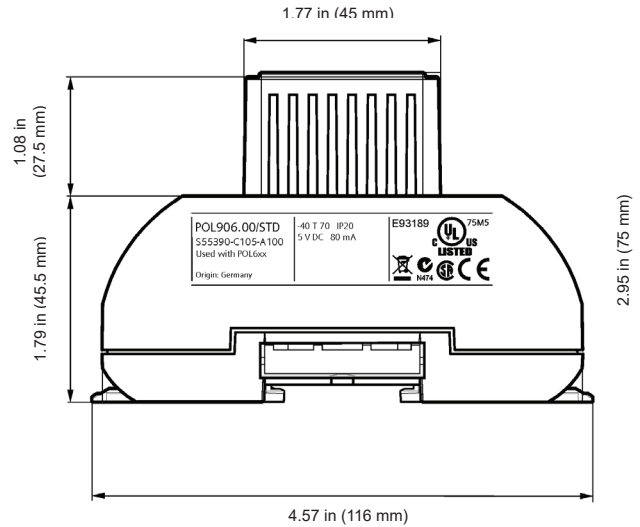

FIGURE 2: LONWORKS Communication Module Side View



Specifications

General	
Dimensions	W x H x D: 1.77 x 4.33 x 2.95 in (45 x 110 x 75 mm)
Weight	3.0 oz (85 g)
Material	Base - plastic, pigeon-blue Housing - plastic, light-gray
Operating	
Temperature	-40 - 158°F (-40 - 70°C)
Humidity	<90% RH
Atmospheric pressure	Min. 10 psi (70kPa), corresponding to max. 9,842 ft (3,000 m) above sea level
Storage and Transportation	
Temperature	-40 - 158°F (-40 - 70°C)
Humidity	<95% RH
Atmospheric pressure	Min. 3.77 psi (26 kPa), corresponding to max. 32,808 ft (10,000 m) above sea level
Electrical	
Power	Supplied via unit controller DC 5 V (+5% / -5%), max. 80 mA
Network cable	LON interface: Plug-in terminals 2 wires, interchangeable
Bus connection/ Transceiver	Galvanically isolated, 78k baud TP/FT-10 transceiver Connection to Bus via the T1 port Terminal plug: 2-pin spring cage top entry
LONWORKS data memory	56 kbyte flash memory for the user application
Additional Components	
Board-to-board connector	10-pin plug between module and unit controller
Agency Listings	
US	UL916, UL873
Canada	CSA C22.2M205
Europe EMC directive	2004/108/EC
Low-voltage directive	2006/95/EC
RoHS directive	2002/95/EC

Component Data

The LONWORKS communication module is a printed circuit board with a plastic enclosure. It connects directly to the left-hand side of the unit controller as shown in [Figure 3](#). It may

be possible that another module is also connected to the unit controller. In this case, the LONWORKS communication module simply attaches directly to the left side of the existing module instead of the unit controller.

Figure 3: LONWORKS Communication Module Attached to Unit Controller

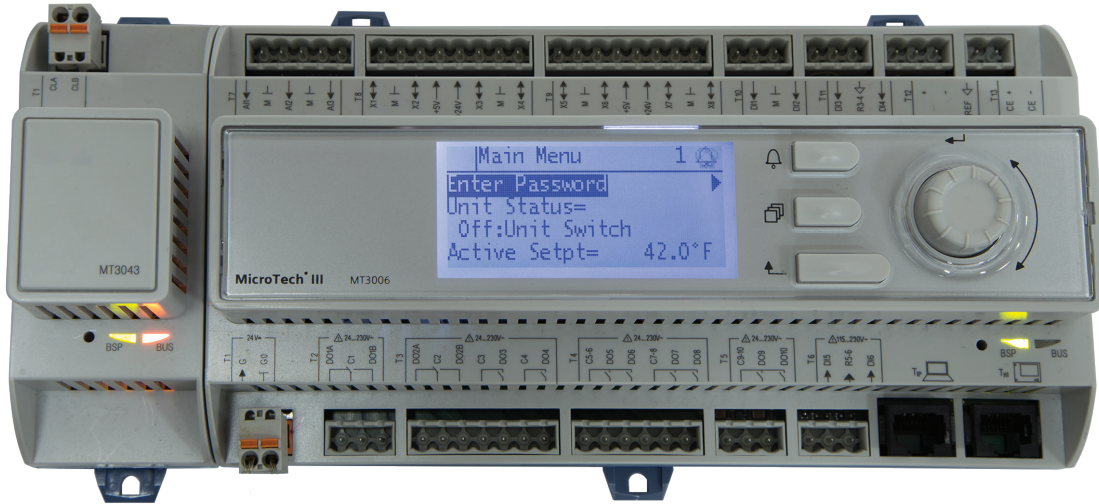

[Figure 4](#) shows the important features of the LONWORKS communication module, which are described in the following section.

Figure 4: LONWORKS Communication Module - Main Features

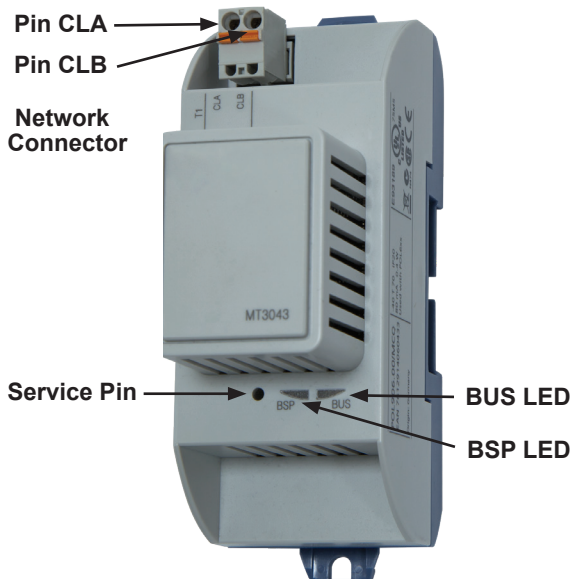

Service Pin

The service pin generates a service-pin message that contains the Neuron® ID and the program code identification of the node. The service pin message is used to commission the LONWORKS communication module by broadcasting it on the network ([Figure 4](#) and [Figure 5](#)).

The service pin button is located below the enclosure just left of the LEDs. The service pin is activated by inserting a small tool into the button. See [Commissioning](#) section for details.

Figure 5: Service Pin Detail

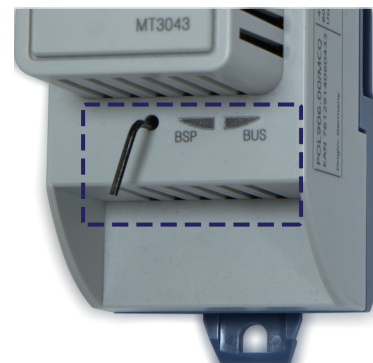

Light Emitting Diodes (LEDs)

The LONWORKS communication module has two LEDs that indicate communication activity and network status. These indicators are visible when the communication module is connected to the unit controller and the unit is powered on (Figure 4).

BSP LED

The BSP LED indicates the communication state between the LONWORKS communication module and the unit controller (Table 1).

Table 1: BSP LED Activity

BSP LED Color	Meaning
Flashing between Red and Yellow	Fail safe mode. Download LON BSP again. This normally happens after downloading BSP 9.26 or later. For later versions of BSP, two downloads are required. After the first download, the card enters this fail safe mode.
Flashing between Red and Green	Board Support Package (BSP) upgrade in progress
Green	Communication is established between the communication module and the unit controller.
Yellow	The communication module is capable of communicating to the unit controller. However, communication is not established.
Red flashing with 2Hz	Red flashing with 2Hz = Software error ¹
Red	Hardware error ¹

¹ In the event that this should occur, cycle power to the unit controller to attempt to clear the problem. Contact the Controls Customer Support Group at 866-462-7829 for additional assistance if necessary.

BUS LED

The BUS LED indicates the communication status between the LONWORKS communication module and the network (Table 2).

Table 2: BUS LED Activity

BUS LED Color	Description
Green	The unit controller is capable of communicating to the network.
Yellow	The communication module is initializing.
Yellow flashing	The unit controller has not yet communicated with the network.
Red	Hardware error.

LONWORKS Network Connector

The network connector is the physical connection between the LONWORKS communication module and the FTT-10A network bus. Two pins are used for this purpose as indicated below and shown in Figure 4.

Pin	Function
CLA	FTT-10A
CLB	FTT-10B

Board-To-Board Connector

The 10-pin board-to-board connector connects the unit controller to the LONWORKS communication module (Figure 6 - Figure 8).

Figure 6: Board-to-Board Connector

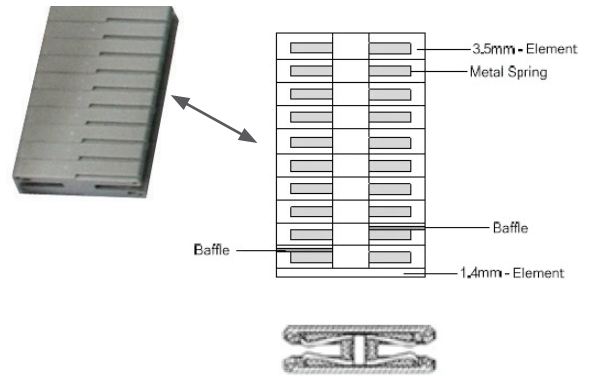

Neuron ID

The basis of the LONWORKS communication module is an Echelon Neuron integrated circuit (Neuron chip). Every Neuron chip has a unique 48-bit Neuron ID or physical address. The Neuron ID can be used to address the device on the LONWORKS network. The Neuron ID is generally used only during initial installation or for diagnostic purposes. For normal network operation, a device address is used.

Transceiver

The LONWORKS communication module is equipped with an Echelon Free Topology Transceiver (FTT-10A) to enable network communication. The transceiver supports free network topology (including ring, star, and daisy-chain) using unshielded, twisted pair cable with polarity insensitive connections at each node. Free topology segments require termination for proper transmission performance. Data transmission rate on the network is 78 kbps (baud).

Bus Termination



Bus termination resistors are used for properly terminating a network based on twisted pair cabling with attention to impedance.

Table 3: Transmission Specifications

Component	Value
Network topology	Flexible Free Topology
Neuron chip processor	3150
Transceiver (FTT-10A)	50051
Cable types	TIA Category 5 (recommended)
Max cable length	1476 ft (450 m) per segment (total of all lines)
Max node separation	820 ft (250 m)
Data transmission	Two-wire, half duplex
Data transmission rate	78 kbps (baud)
Bus terminator	Free topology: use one (1) 52.3 Ω bus terminator at the busiest point of the network Daisy chain or standard line (dual) topology: use two (2) 105 Ω bus terminators at the end of both network segments.
Repeaters and routers	Repeaters and router are typically used when the entire cable length in a given segment exceeds 1476 ft (450 m) in a free topology or 2953 ft (900 m) in a line topology. Each trunk can have at maximum one physical repeater. Repeaters and routers may not be used in a ring topology. They must be placed before the network's ring port.

Installation and Mounting

The following section describes how to field install a new LONWORKS communication module or replace an existing module on the unit controller.

 CAUTION
<p>Electrostatic discharge hazard. Can cause equipment damage.</p> <p>This equipment contains sensitive electronic components that may be damaged by electrostatic discharge from your hands. Before you handle a communication module, you need to touch a grounded object, such as the metal enclosure, in order to discharge the electrostatic potential from your body.</p>
 WARNING
<p>Electric shock hazard. Can cause personal injury or equipment damage.</p> <p>This equipment must be properly grounded. Only personnel knowledgeable in the operation of the equipment being controlled must perform connections and service to the unit controller.</p>

Field Installation Kit

The LONWORKS communication module field-installed kit ships with the following items:

- The LONWORKS communication module
- Board-to-board connector - [Figure 6](#)

Refer to [Parts](#) for field replacement details.

Installing a new Communication Module

Follow these steps to install a LONWORKS communication module on the unit controller. The communication module can be connected directly to the unit controller itself or to an existing module, if one is attached.

NOTE: There is a limit of three devices that can be attached to the left side of the unit controller.

1. Set the "Control Mode = Off" from the main menu on the unit controller display. This must be done prior to installing a new communication module.
2. Remove power from the unit controller.
3. Carefully remove the blue plastic knockout strip on the far left end of the unit controller itself (or additional module, if present). [Figure 7](#) shows the knockout strip after it has been removed from the unit controller.

NOTE: To prevent damage to the unit controller, insert a small flathead screwdriver or similar tool into the tab on the bottom of the unit controller and pull the screwdriver away from the controller.

4. Carefully remove the blue plastic knockout strip on the right side of the LONWORKS communication module.

Figure 7: Communication Module and Knockout

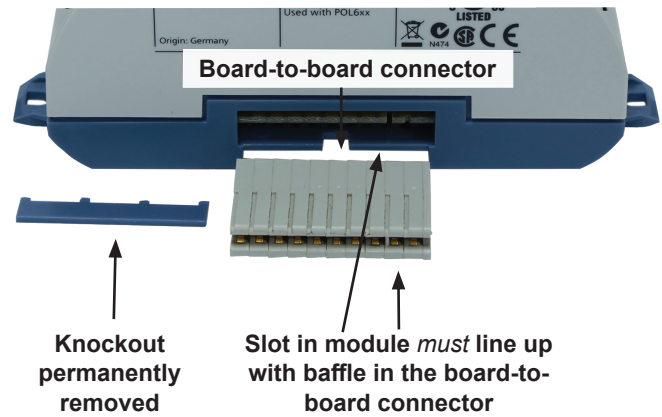

5. Insert the board-to-board connector into the LONWORKS communication module. Note that it only fits one way and that the baffles must line up with corresponding slots in LONWORKS communication module and the unit controller ([Figure 7](#) and [Figure 8](#)).

Figure 8: Communication Module with Board-to-Board Connector Inserted



6. Insert the other end of the board-to-board connector to the far-left side of the unit controller or other module, if attached.
7. Connect the LONWORKS communication module to the network by inserting a network cable into the communication module's network connector ([Figure 4](#)).
8. Apply power to the unit controller.

The unit controller automatically resets itself approximately 30 seconds after power has been applied to it. This reset is necessary so that the LONWORKS communication module can synchronize with the unit controller.

Replacing a Communication Module

Follow these steps to remove an existing LONWORKS communication module from the unit controller and replace it with a new module.

1. Set the "Control Mode = Off" from the main menu on the unit controller display. This must be done prior to replacing a communication module.
2. Remove power from the unit controller.
3. Locate the LONWORKS communication module to the left of the unit controller (Figure 3).
4. Gently pull the network cable connector from the LONWORKS communication module (Figure 4).
5. Grasp the LONWORKS communication module and gently pull it from the unit controller (or from an adjacent module, if present).
6. Install the new LONWORKS communication module:
 - a. Carefully remove the blue plastic knockout strip on the right side of the LONWORKS communication module.
 - b. Insert the board-to-board connector into the LONWORKS communication module. Note that it only fits one way and that the baffles must line up with corresponding slots in the communication module and the unit controller (Figure 7).

6. Insert the network cable connector into the LONWORKS communication module (Figure 4).
7. Apply power to the unit controller.

NOTE: The unit controller automatically resets itself approximately 30 seconds after power has been applied to it. This reset is necessary so that the LONWORKS communication module can synchronize with the unit controller.

Refer to MicroTech 4 Rebel Applied Unit Controller Operation Manual (OM 1288) or MicroTech Commercial Rooftop Air Handling Unit Controller Operation Manual (OM 920) for unit controller display menu details.

Commissioning and Configuration

LONWORKS Network Addressing

After the LONWORKS communication module has been installed, the unit controller is ready for integration into a building automation system (BAS). The following section explains how the communication module, together with the unit controller, support LONWORKS network addressing requirements. It then provides instructions for commissioning and configuring the communication module. Integrating the LONWORKS communication module into a BAS involves three steps:

- Connecting the unit (node) to the network
- Addressing and establishing communications with the unit
- Configuring the unit to the building

Each LONWORKS communication module is equipped with an FTT-10A transceiver for network communications. This transceiver allows for (1) free topology network wiring schemes using twisted pair (unshielded) cable and (2) polarity insensitive connections at each node. Free topology segments require termination for proper transmission performance.

Refer to Echelon LONWORKS FTT-10A Transceiver User's Guide for details regarding acceptable configurations, cabling requirements, terminations, and other requirements for proper connection of the unit to the LONWORKS network (www.echelon.com).

According to the standard, all device addresses are defined at the time of network configuration. Device addresses have three parts:

1. The Domain ID - designates the domain. Devices must be in the same domain in order to communicate with each other.
2. The Subnet ID - specifies a collection of up to 127 devices that are on a single channel or a set of channels connected by repeaters. There may be up to 255 subnets in a domain.
3. The Node ID - identifies an individual device within the subnet.

Each LONWORKS device has a neuron chip with a unique 48-bit Neuron ID (Node ID) or physical address. This address is generally used only at initial installation or for diagnostic purposes. For normal network operation, a device address is used.

A group is a logical collection of devices within a domain. Groups are assembled with regard for their physical location in the domain. There may be up to 256 groups in a domain. A group address is the address that identifies all devices of the group. There may be any number of devices in a group when unacknowledged messaging is used. Groups are limited to 64 devices if acknowledged messaging is used.

A broadcast address identifies all devices within a subnet or domain.

External Interface File (XIF) and NXE Files

LonMark guidelines specify exact documentation rules so that proprietary configuration tools are not required to commission and configure LONWORKS devices. The LONWORKS communication module is self-documenting so that any LONWORKS network management tool can obtain all the information needed over the network to connect it into the system and to configure and manage it.

An external interface file (a specially formatted PC text file with the extension .XIF) is required, along with LONWORKS network management tool, so that you can design and configure the device prior to installation.

The NXE file contains the application image that is downloaded into the LONWORKS communication module. The LONWORKS communication module uses a separate NXE file, depending on whether the unit is configured for the DAC or SCC functional profile.

The XIF and NXE files are available at www.DaikinApplied.com or www.lonmark.org. Also refer to the appropriate Unit Controller Integration Guide for descriptions of the available LONWORKS variables. See [Reference Documents](#) for literature descriptions and locations.

Resource Files

Resource files contain definitions of functional profiles, network variables types, configuration property types, and enumerations. Resource files are required for 1) displaying Daikin-specific variables that are not included in the standard device profile or 2) switching from one device functional profile to another (SCC to DAC or vice versa). The LONWORKS communication module uses a separate set of resource files, depending on whether the unit is configured for the DAC or SCC functional profile. These files are available at www.DaikinApplied.com or www.lonmark.org.

Commissioning

Follow these steps to commission the LONWORKS communication module and establish network communication:

1. Verify the communication module is attached properly to the unit controller.
2. Connect the twisted pair cable to the communication module's network connector pins CLA and CLB ([Figure 4](#)).
3. Download XIF, NXE, and Resource Files from either www.DaikinApplied.com or www.lonmark.org.
4. Use a LONWORKS network configuration tool, such as LonMaker®, to map the device Neuron ID to the domain/subnet/node logical addressing scheme when it creates the network image, the network address, and connection information.
5. Confirm that the BAS is ready to receive a network device broadcast message.

- Press the service pin button. Do this by inserting the end of a 5/64" (2.0 mm) flathead screwdriver, Allen wrench, or similar tool with a narrow end, approximately 1.5 inches (3.8 cm) into the small hole to the left of the LEDs (Figure 5).

At this point, the initialization process begins. See Table 1 and Table 2 for descriptions of BSP and BUS LED activity. Once both LEDs turn a steady green, the module is capable of communicating between both the unit controller and the LonWorks network.

NOTE: Always cycle power to the unit controller after 1) commissioning a device, 2) de-commissioning an existing device, and 3) subsequent re-commissioning of an existing device.

Figure 9: Unit Controller Main Features

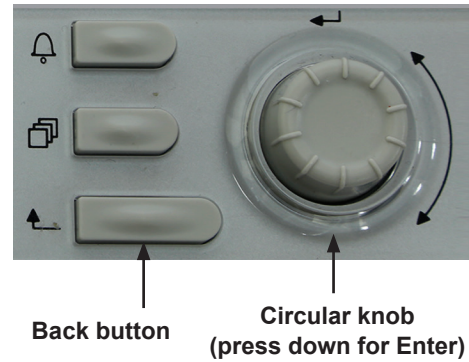

Configuration

There are certain parameters that can be configured using the unit controller display menu. These variables are described in Table 3. As a general rule, the LONWORKS communication module does not require configuration unless advised by the network administrator.

NOTE: Receive Heartbeat, Max Send Time, and Min Send Time are typical parameters that may need to be changed for your network. They should be modified on an as-needed basis. Maintain default values if possible.

The following steps describe how to set Receive Heartbeat for your network. The same procedure can also be applied to Max Send Time and Min Send Time.

Enter Password

- If you have not already entered a password and are on the Main menu screen, turn the circular knob on the unit controller (Figure 8) until Enter Password is highlighted from the menu list (Figure 10). If you have already entered a password, skip to Step 3.
- Select Enter Password by pressing down on the circular knob.

NOTE: If you are not at the Main Menu and need to enter a password, press the Back button from any other menu screen until you reach the Main Menu and then follow steps 1-3.

- Enter Password 6363 and then press Enter.
- Scroll down to BMS Communications and press Enter.
- Navigate to the LON Set-Up menu on the unit controller keypad display (Figure 10)

Figure 10: Main Menu: Enter Password

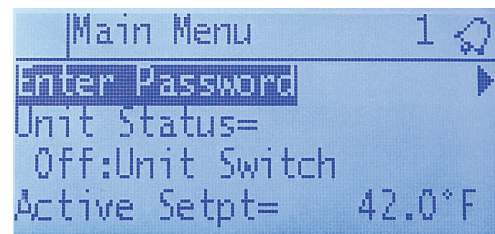

Set Receive Heartbeat

- Turn the circular knob clockwise to scroll down to RecHrtb. Press Enter and then modify as directed by the network integrator.
- Navigate back to the LON Set-Up menu. Change any other parameters shown in Table 3 as necessary.

NOTE: Any changes to network settings are automatically saved.

Figure 11: LON Set-Up Menu



Refer to MicroTech 4 Rebel Applied Unit Controller Operation Manual (OM 1288) or MicroTech Applied Air Handling Unit Controller Operation Manual (OM 920) for default values and keypad operating instructions. Refer to the respective Unit Controller Integration Guide for all LONWORKS parameters and other network communication information. See Reference Documents.

Table 4 defines the network parameters of the LONWORKS communication module available from the BMS Communications/LON Set-Up menu on the unit controller.

Change parameters as required for your network.

TABLE 4: LONWORKS Network Parameters

Parameter	Range/Default	Description/Notes
Neuron ID	Variable Default: NA	Indicates the Neuron ID of the LONWORKS communication module The Neuron ID field displays zeros and does not populate until the communication module has been commissioned.
Max Send Time	0 - 6553.5 seconds Default: 0 seconds	Maximum Send Time. Controls the maximum period of time that expires before certain network variables are transmitted. nciMaxSendTime can also be used to change these values ¹
Min Send Time	0 - 6553.5 seconds Default: 10 seconds	Minimum Send Time. Controls the minimum period of time that expires before certain network variables can be retransmitted. nciMinSendTime can also be used to change these values ¹
Rcv Heartbeat	0 - 6553.5 seconds Default: 0 seconds	Receive Heartbeat. Defines the maximum time that elapses after the last update to a specified network variable input before the unit starts to use default values. nciRCvHrtBt can also be used to change these values ¹
LON BSP ²	10.14 Default: NA	Board Support Package. Displays the version of firmware loaded in the LONWORKS communication module.
LON App Ver ²	Variable	LONWORKS application version. Displays the version of the chiller software application loaded in the LONWORKS communication module. The asterisk (*) indicates the revision number. This parameter remains blank until the communication module is commissioned.

1. Requires the use of LonMaker or other LONWORKS configuration tool.
2. The LON BSP and software application version are read-only.

Service Information

Troubleshooting

Follow these procedures if you can control the unit controller from the display menu, but unable to communicate from the network.

General

- Review the [Commissioning](#) section of this document to confirm that all procedures were followed correctly.
- If the communication module is installed but LEDs are not active when the unit controller is powered up, remove the module and then follow the steps provided in the [Application](#) section. If the issue persists, replace the module.
- Verify that the LON Set-Up menu appears in the unit controller keypad/display. If it does not, follow this procedure:
 1. Remove power from the unit controller, wait 10 seconds, then re-power the unit controller. Within 45 seconds, the unit controller should recognize the attached communication module, and will cycle power.
 2. Verify that the LON Set-Up menu now appears in the unit controller display menu.

Network Wiring and Connections

- Check for faulty cable connectors at the LonWorks communication module and throughout the network.
- Determine if there is a network ground fault.
- For network terminal connections, twist the wires together a minimum of three times.
- Use only approved cable. Do not use different wire types on the same bus.
- Follow the bus length limits for the cable type.
- Confirm that you have the correct transceiver.
- Make sure that the network trunk avoids strong sources of electromagnetic interference (EMI).
- Verify that the network trunk is not located near a DC load switch (relay).

Bus terminators

Errors from bus termination can have the following results:

- Signal level too low could indicate the wrong bus terminator or too many terminators.
- Signal level too high could indicate a high-level signal or signal reflections point due to a missing or wrong bus terminator, or that bus terminators are placed incorrectly.
 - Verify that the correct terminators are used based on your network topology.
 - Free topology should have a single 52.3 Ω bus terminator at busiest point of network.
 - Line topology should have two (2) 105 Ω bus terminators at both network ends.

Network Performance

- If network traffic is slow, communication is intermittent, or the trunk is experiencing “noise,” it may be necessary to use a network protocol analyzer or oscilloscope to determine the source of poor performance.
 - Confirm power is applied to the unit controller.

Parts

Table 5: Replacement Kits

Description	Part Number
MicroTech Commercial Rooftop and MicroTech 4 Applied Rooftop LONWORKS Communication Module Kit, Space Comfort Controller (SCC). Kit includes communication module, board-to-board connector, and Installation Manual.	090016711
MicroTech/MicroTech 4 Applied Rooftop LONWORKS Communication Module Kit, Discharge Air Controller (DAC). Kit includes communication module, board-to-board connector, and Installation Manual.	090016712

Technical Support

Contact Daikin Applied Controls Technical Support at 866-462-7829 for additional assistance.

Refer to the appropriate Unit Controller Operation Manual for additional information about using the unit controller display menu options for setting unit parameters and modifying unit setpoints. Also refer to the respective Unit Controller Integration Guide for all Lonworks parameters and other network communication information. See [Reference Documents](#).

Revision History

Revision	Date	Changes
IM 918	October 2008	Preliminary release.
IM 918-1	January 2009	Updated Figure 3 and text for setting service pin with hex key.
IM 918-2	October 2009 March 2012	Added Maverick II (MPS) model Updated to Daikin logo and references. Added Rebel to cover Modified the BSP LED table to add the fail safe LED sequence.
IM 918-3	December 2019	Layout rebranded. Added MicroTech 4 Rebel Applied model type and associated references throughout.
IM 918-4	January 2021	Fixed incorrect Rebel Applied OM number in Reference Documents table and cross references used in the IM.
IM 918-5	June 2023	Branding and other formatting updates.



Daikin Applied Training and Development

Now that you have made an investment in modern, efficient Daikin Applied equipment, its care should be a high priority. For training information on all Daikin Applied HVAC products, please visit us at www.DaikinApplied.com and click on Training, or call 540-248-9646 and ask for the Training Department.

Warranty

All Daikin Applied equipment is sold pursuant to its standard terms and conditions of sale, including Limited Product Warranty. Consult your local Daikin Applied Representative for warranty details. To find your local Daikin Applied Representative, go to www.DaikinApplied.com.

Aftermarket Services

To find your local parts office, visit www.DaikinApplied.com or call 800-37PARTS (800-377-2787). To find your local service office, visit www.DaikinApplied.com or call 800-432-1342.

This document contains the most current product information as of this printing. For the most up-to-date product information, please go to www.DaikinApplied.com.

Products manufactured in an ISO Certified Facility.