

MAGNITUDE[®] WMT

MAGNETIC BEARING OIL-FREE CENTRIFUGAL CHILLERS



- MODEL WMT
- 350 TO 600 TONS (1200 TO 2200 kW)
- R-1233zd(E) REFRIGERANT



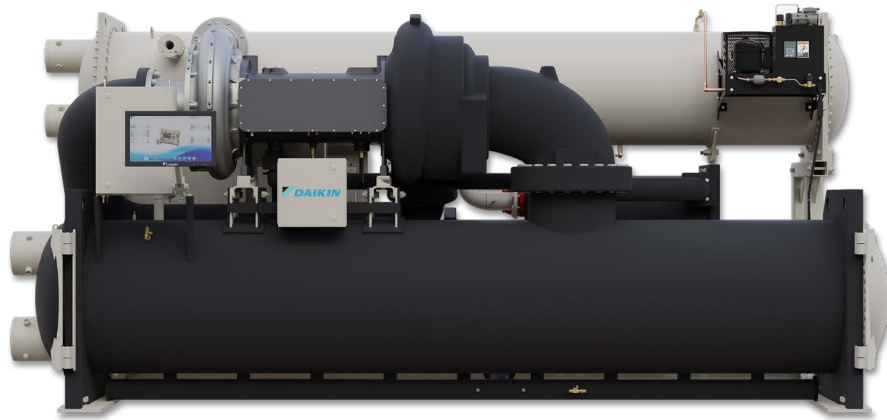



LOW PRESSURE REFRIGERANT & OIL-FREE MAGNETIC BEARING TECHNOLOGY



The HVAC industry's next generation of water-cooled centrifugal chillers has arrived with the Daikin Applied Magnitude® WMT chiller; incorporating a two-stage centrifugal compressor and unit-mounted variable frequency drive (VFD) with **oil-free, magnetic bearing technology**. WMT's advanced compressor improves performance and decreases electrical requirements for up to **40% more energy savings** than traditional fixed-speed centrifugal chillers. Utilizing real-time sensors and fewer moving components, the digital bearing control system maintains perfect compressor shaft alignment to produce superior performance and dependable, long-life operation.

Direct-drive technology and an optimized compressor-refrigerant combination are incorporated with highly efficient heat exchangers to further maximize performance for a fully configurable design. The result? **WMT is the only chiller on the market to utilize a two-stage, oil-free compressor with R-1233zd(E) refrigerant**. It also offers the **smallest footprint and unit volume in the industry** compared to similar capacity magnetic bearing centrifugal chillers using R-1233zd(E). These capabilities are available for the entire capacity limits of WMT, ranging from 350 to 600 tons (1200 to 2200 kW) at standard AHRI conditions.

PERFORMANCE

-  R-1233zd(E)
-  350-600 tons
-  79 dB(A) sound levels
-  40% greater efficiency
-  0.50 kW/T full-load efficiency
-  0.30 kW/T part-load efficiency
-  Ultra-wide operating envelope with free-cooling, inverted duty

LINKS:

 [Installation & Operation Manual](#)

 [Engineering Submittal Data](#)

CERTIFICATIONS



TABLE OF CONTENTS

Overview	2	Dakin360 Maintain & Repair	9
Advantages/Technologies	4	Dakin360 Parts & Supplies	10
Features & Benefits	6	Dakin360 Rental Solutions	11
Vertical Markets/Applications	7	Complete HVAC System Solutions	12
Water-cooled Chiller Solutions	8		

Environmentally Friendly

As we become more aware of the environmental impact of their energy consumption and look for ways to reduce carbon footprint, the demand for electric HVAC systems has grown. Magnetic-bearing, electric HVAC chillers like WMT produce **lower emissions** compared to traditional centrifugal chillers, making them an attractive option for building owners and facility managers looking to **reduce carbonization**. No lubrication (oil) is used, which minimizes the risk of pollution from lubricant leaks or spills. Magnetic bearing technology also reduces mechanical wear and tear, yielding increased reliability and equipment longevity, which in turn lowers landfill impact associated with production and disposal of equipment.



ASHRAE Standard 34 Safety Groups

Higher Flammability (3)	A3	B3
Flammable (2)	A2	B2
Lower Flammability (2L)	A2L	B2L
No Flame Propagation (1)	A1	B1
	Lower Toxicity (A)	Higher Toxicity (B)

Low GWP Refrigerant

WMT is designed around R-1233zd(E) – an ultra-low GWP next generation refrigerant for low pressure machines. It has a GWP value of just 1 and an A1 safety group classification, yielding the lowest flammability and toxicity scores possible. This, combined with being a **highly efficient refrigerant**, makes R-1233zd(E) a long-term, sustainable solution. By adopting this refrigerant, WMT directly contributes to the reduction of greenhouse gas emissions, lowering the impact on climate change. Building owners often wish to pursue Leadership in Energy and Environmental Design (LEED) Green Building Certification. Enhanced Refrigerant Management (formerly EA Credit 4) qualification is partially determined by tonnage and refrigerant quantity, which allows WMT chillers to be **LEED certified**.

Industry-Leading Performance

As the first HVAC manufacturer to bring magnetic bearing chiller technology to market, Daikin Applied Magnitude chillers have led the industry; boasting a nearly 40% greater efficiency over traditional oiled centrifugals. The new WMT chiller offers the **best performance in the market** – capable of 0.50 kW/ton full load efficiency and 0.30 kW/ton part load IPLV. This is in part thanks to WMT’s **wide operational envelope** – enabling the chiller to produce high evaporator leaving water temperatures up to 80°F, high condenser leaving water temperatures up to 119°F, low condenser entering water temperatures down to 40°F and operation **down to 10% capacity** without the need for hot gas bypass.

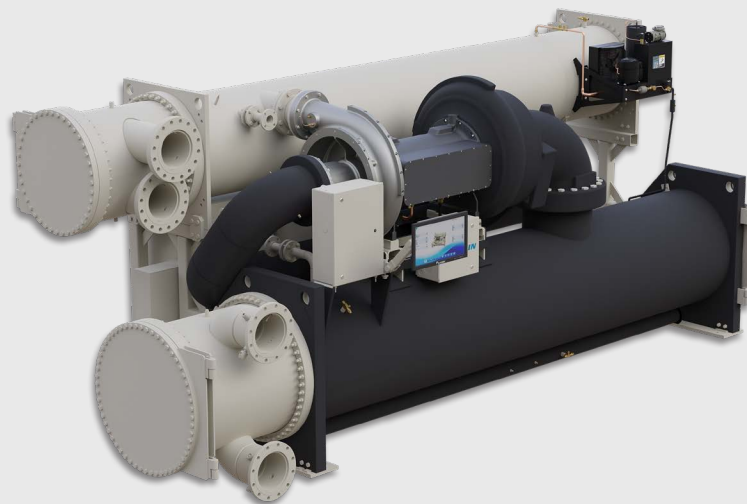

40%

GREATER EFFICIENCY

Quiet Full-Load Capacity

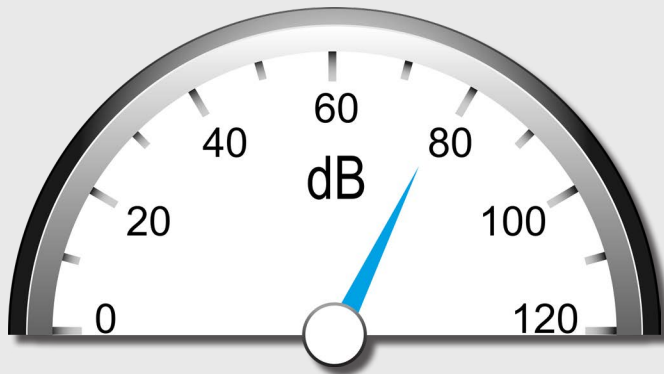

Sound pressure levels (SPL) as low as 79 dB(A) at full load capacity in accordance with AHRI Standard 575 means **minimal noise distractions**. WMT achieves even quieter operation at reduced loads and non-standard conditions. Schedule a personal visit at the factory to see your own chiller's operation, performance and sound testing, or opt for a convenient remote/non-witness test.

Compact Footprint

The compact size of a Magnitude WMT chiller is ideal for both new and replacement installations. It's a perfect fit when looking to maximize usable space while minimizing installation costs. WMT provides the **smallest footprint and unit volume in the market** among similar capacity R-1233zd(E) magnetic bearing chillers – optimizing floorspace and minimizing installation costs that are critical to customers.

Knockdown Disassembly

WMT chillers can also accommodate more challenging access projects using a factory, **knock-down disassembly option**, with various package options during transportation and installation of the unit. Knockdown disassembly means that the unit can be broken down into smaller, more manageable pieces that make it easier to transport to the installation site. Additionally, it can also make it easier to maneuver the unit into tight or difficult-to-reach spaces, reducing the overall installation time and effort. This can be particularly beneficial in retrofit or renovation projects where space constraints may be a concern.

**IDEAL FOR
RETROFIT &
RENOVATION**

**NAVIGATE SMALL
CORRIDORS & TIGHT
SPACES EASILY**



Maximum Uptime

Power failures can turn into a critical loss of cooling in mission critical facilities such as data centers, hospitals or manufacturing buildings. These applications call for stringent capabilities for chillers to restart or resume operation quickly. WMT offers the **best uptime capabilities in the industry** and has low inrush current at startup, ideal for operation with backup or emergency power systems. Other chillers may require adding expensive thermal storage tanks, but WMT simplifies ownership thanks to RideThrough® and RapidRestore®. Combine this with WMT's operation down to 10% capacity without hot gas bypass, and facility managers can breathe easier with decreased disruptions to vital services.

RIDETHROUGH®

WMT chillers feature Daikin Applied's unique power trip resilience technology called RideThrough, which **maintains operation, even during a power loss, for up to 10 seconds** – a feature that no other competitor is known to offer. This is most beneficial when a backup generator is on site, as it typically takes less than 10 seconds to turn on and provide power back to the unit. With RideThrough, when power goes out, the compressor motor maintains rotation and the VFD catches and resynchronizes with the spinning rotor. This allows the chiller to push straight through a short-term power loss and return to its pre-power loss capacity within seconds, without shutting down and rebooting. When the motor isn't drawing power, it serves as a generative power system, temporarily feeding the bearings and controls with energy.

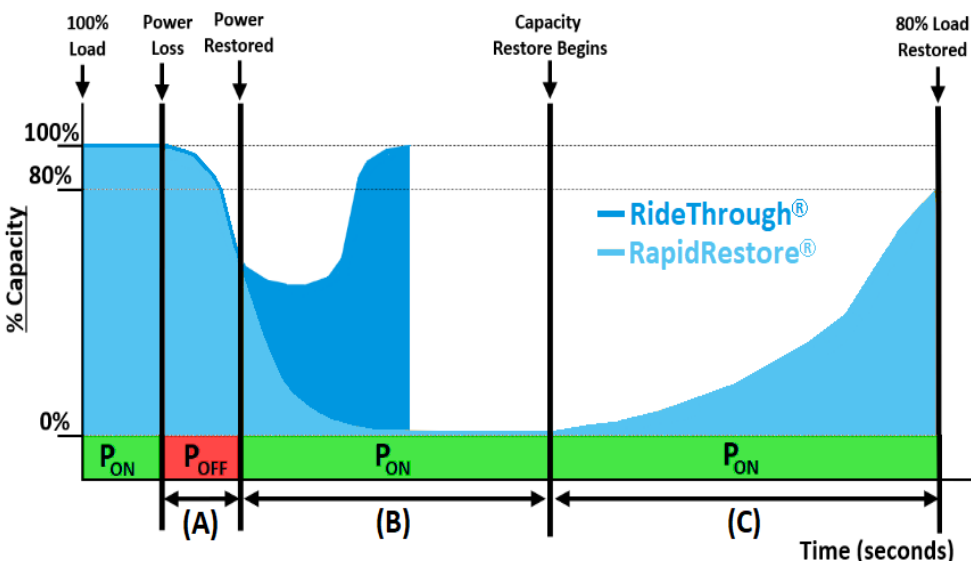

RAPIDRESTORE®

When power outage times exceed the RideThrough threshold, Magnitude WMT again has the best solution in the industry – RapidRestore. With RapidRestore, WMT surpasses other chillers' **quick start-up and fast loading** abilities in record times. WMT can restart in as little as 30 seconds after power is restored and then restores 80% cooling capacity in less than 70 seconds.

	RideThrough®	RapidRestore®	
	Power Trip Resilience (A)	Chiller Reboot (B) ³	80% Capacity (C)
WMT	10 sec ¹	30 sec ^{2,4}	70 sec
Competitors	Not offered	30-65 sec	80-130 sec

¹ Max power loss duration to maintain operation - condition dependent
² Restart time with UPS (without UPS = 60 sec)
³ Time after power is restored
⁴ Dependent on power loss duration

10 SECONDS
OF CONTINUED
OPERATION

30 SECOND
CHILLER
REBOOT

70 SECOND
RESTORE TO 80%
COOLING CAPACITY

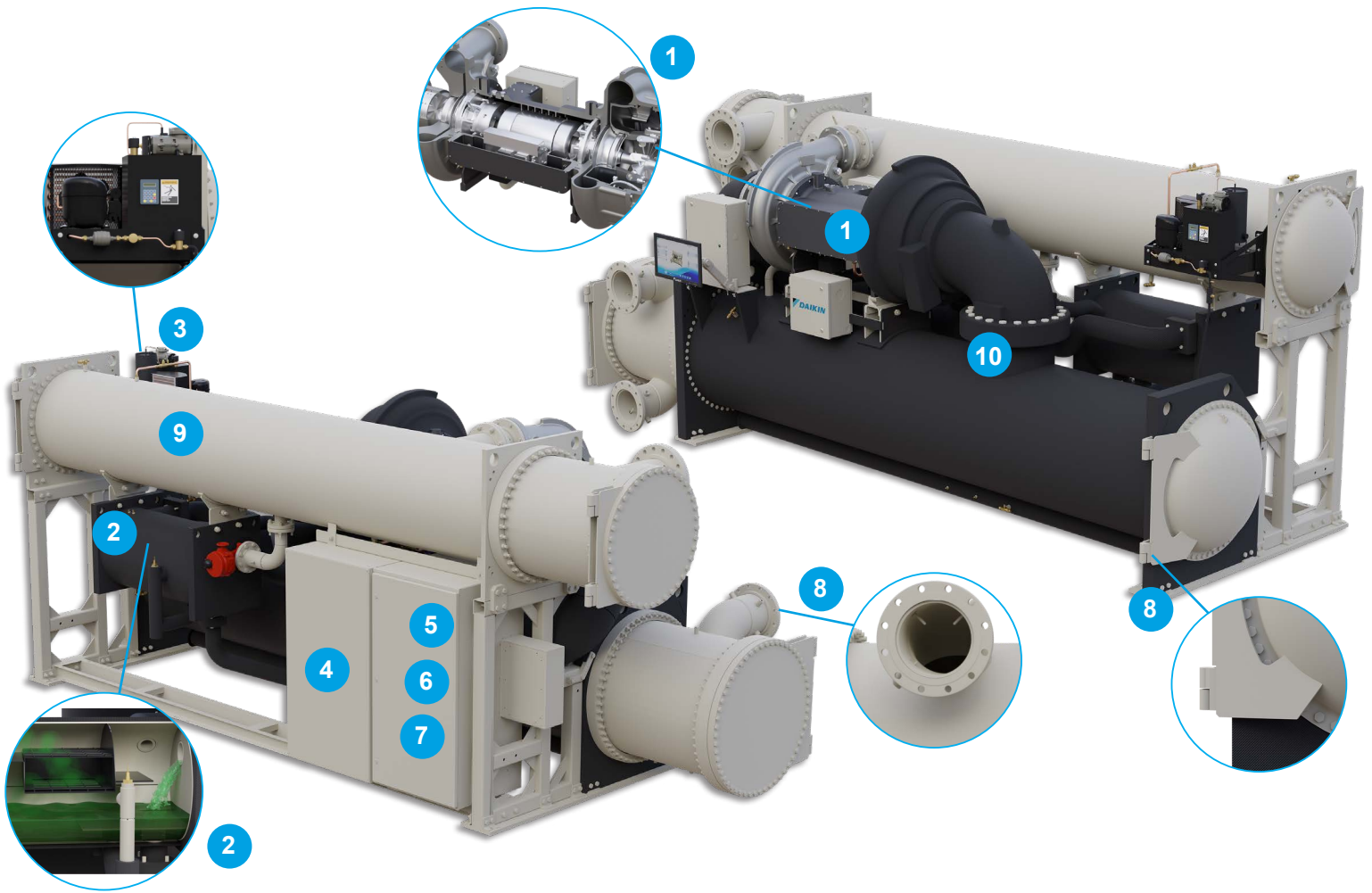

1 MAGNETIC BEARING COMPRESSOR MOTOR

- Oil-free, refrigerant-cooled, in-house design reduces maintenance
- Digitally controlled with real-time sensors maintains perfect alignment
- Unique back-to-back, two-stage impeller configuration balances thrust loads & reduces aerodynamic losses
- Soft start increases motor life

2 REFRIGERANT ECONOMIZER

- Works with the two-stage compressor to improve efficiency across all load points
- Inverted operation eliminates expensive external waterside economizer system

3 PURGE UNIT

- Minimizes refrigerant contaminants from non-condensable gases for efficient, trouble-free operation.

4 VARIABLE FREQUENCY DRIVE (VFD)

- Unit mounted & air-cooled eliminates clogging and overheating that other chillers experience using fouled condenser water
- Reduces in-rush current, generator size, & power consumption

5 ELECTRICAL INTERFERENCE FILTERS

- Optional unit-mounted electromagnetic interference filters suppress electromagnetic noise
- Optional harmonic filter mitigates VFD distortions

6 SHORT CIRCUIT CURRENT RATINGS (SCCR)

- Power panels up to 100kA allow for a variety of utility configurations and building code compliance

7 GROUND FAULT PROTECTION

- Protects equipment from line-to-ground fault currents

8 WATER CONNECTIONS

- Optional hinges allow for quick vessel serviceability & optional flanged nozzles integrate easily into buildings

9 ASME VESSELS

- Quality ASME standard construction bears high refrigerant & water side design pressures from 150-300 psig to meet many pump systems

10 INSULATION

- Optional single or double thickness mitigates condensation in high-humidity environments and improves efficiency

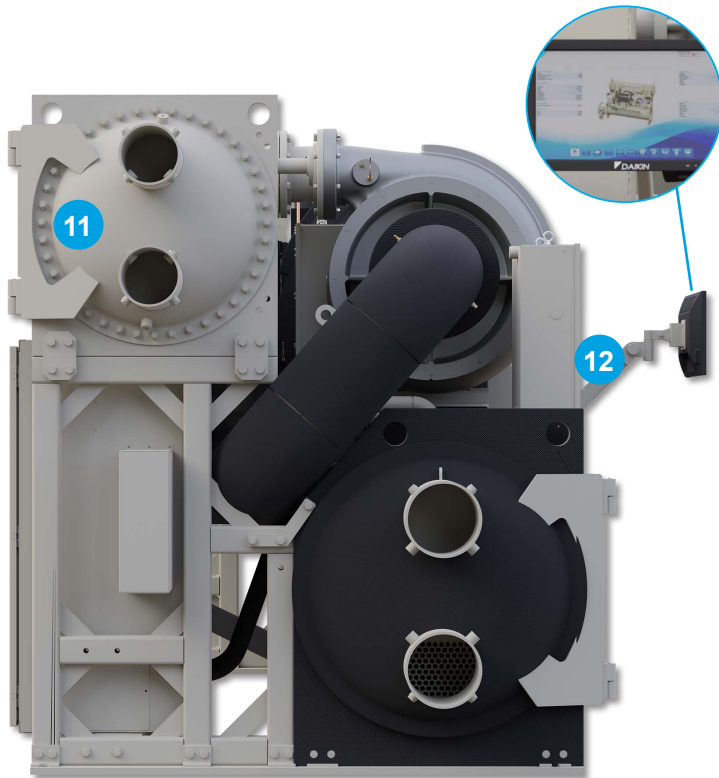

11 PROTECTIVE COATINGS

- Various tube thicknesses and material types extend the life of the equipment in harsh water systems
- Optional tube sheet or water box coating materials & alloy anodes are anti-corrosive

12 CONTROLS/AUTOMATION

- Movable HMI panel attached to unit with high-contrast, color touch screen
- Real-time trend graphs, chiller monitoring and performance data with animated graphics & control
- MicroTech[®] controllers monitor operating status & provide fault protections & intuitive setpoint adjustments
- BACnet[®], Modbus[®], or LonWorks[®] data communication options provide easy and affordable integration into a building automation system (BAS)

VERTICAL MARKETS/APPLICATIONS



EDUCATION

Optimize learning environments with WMT's highly-configurable design and quiet operation that reduce operational costs and ensure a comfortable learning environment for both students and staff.



HEALTHCARE

Maximize patient health outcomes with WMT features and benefits tailored for medical office buildings, outpatient clinics, hospitals, nursing homes, and other healthcare facilities.



DATA CENTERS

Gain class-leading efficiency with WMT's lower total lifecycle operating costs while ensuring your data center will remain operational at all times with mission-critical technology.

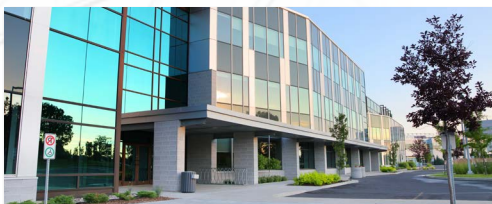

OFFICE BUILDINGS

WMT is ideal for office buildings with limited mechanical room space. A small footprint allows for more flexibility in system design and installation, while still delivering the high-performance cooling capacity required for commercial applications.

WATER-COOLED CHILLER SOLUTIONS



NAME/MODEL:

WATER-COOLED

WGZ
Scroll compressor



30-200 tons

NAVIGATOR®

WWW
Screw compressor



150-300 tons

MAGNITUDE®

WMT
Magnetic bearing compressor



350-600 tons

MAGNITUDE®

WMC/WME
Magnetic bearing compressor

86-1,600 tons



CENTRIFUGAL

WSC
Single compressor

350-1,200 tons



CENTRIFUGAL

WDC/WCC
Dual compressor

1,700-2,500 tons

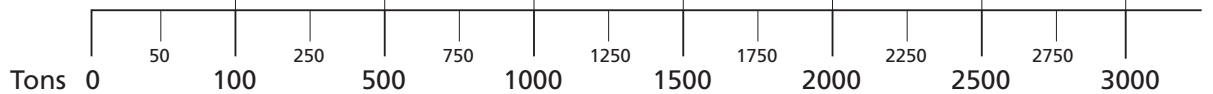
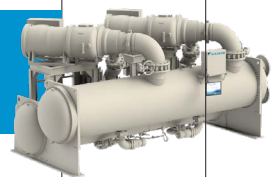

LEARN MORE AT

DAIKINAPPLIED.COM/PRODUCTS/CHILLER-PRODUCTS

MAINTAIN AND REPAIR

PROTECTIVE MAINTENANCE SERVICES

[LEARN MORE](#)

REPAIR SERVICES

Breakdowns happen and when your equipment has an issue, time is of the essence. Call us at 800-432-1342 to get Daikin Service professionals dispatched quickly and minimize downtime. Your local team is backed by nearly 100 years of experience to alleviate undue stress in your operations.

- **24/7 Emergency Service**
- **System Repairs & Assessments**
(Ancillary Equipment: Boilers, Cooling Towers)
- **Equipment Diagnostics**
- **Technical Troubleshooting**
- **Building Automation & Controls**
- **OEM & Generic Parts/Supply**
- **All Equipment Types & Brands**

PLANNED MAINTENANCE SERVICES

Daikin Applied's service technicians can perform all of the vital maintenance your system needs to ensure your equipment is running at peak efficiency. From proper cleaning to software upgrades and necessary maintenance, our techs will maximize your system to help extend the life of your equipment.

- **Regularly Scheduled Maintenance**
- **Seasonal Startup & Shutdown**
- **System Diagnostics**
- **Condenser Cleaning**
- **Air Filters**
- **On-site System Inspections**

PREDICTIVE SERVICES

Predictive maintenance services anticipate failures before they happen to mitigate the risk of catastrophic failure. For those who have in-house maintenance capabilities, Daikin Service can also guide your team and be on standby for more complex technical needs with predictive maintenance.

- **Oil & Refrigerant Analysis**
- **Vibration Analysis**
- **System Diagnostics**
- **Eddy Current Testing**
- **Infrared Analysis**
- **Combustion Analysis**
- **IAQ Assessments**
- **Laser Alignments**
- **Bearing Analysis**

PROACTIVE SERVICES

With proactive maintenance services, we support you with proven experts, offerings and processes to ensure customers get the help they need from a trusted advisor.

- **Building Operations Review**
- **Contingency Planning**



PARTS & SUPPLIES
OEM AND GENERIC AFTERMARKET SOLUTIONS



LEARN MORE



LOCAL PARTS INVENTORY. LOCAL EXPERTISE.



When you need OEM or generic parts to repair your HVAC system, you need them quickly. Daikin Service has an expansive inventory and a centralized distribution center to get the right parts to you faster than ever before. To mitigate downtime, we have 80 locations (and counting) across North America to help you take care of your critical parts demand.



- ONE-STOP SHOP FOR ALL OEM & GENERIC PARTS
- NATIONAL LOCATION/DISTRIBUTION NETWORK
- CENTRALIZED DISTRIBUTION
- FACTORY-AUTHORIZED REPLACEMENT PARTS
- SAME-DAY SHIPPING ON MOST ORDERS
- EXPERT SUPPORT
- RELIABLE PERFORMANCE
- WALK-IN STORE LOCATIONS
- EXTENDED COMPONENT WARRANTIES (VFDS, COMPRESSORS, MOTORS)



RENTAL SOLUTIONS

KEEPING YOU UP AND RUNNING

[LEARN MORE](#)



CHILLERS | AIR CONDITIONERS | DEHUMIDIFIERS | HEATING | POWER

EMERGENCY RENTALS

When your equipment fails, limiting downtime is mission critical. Daikin Applied provides quick delivery and installation of reliable rental products to help you weather the outage. We're here to help get you back up and running, and can provide a turnkey solution.

- **Industry-leading efficiency and proven technology**
- **24-hour turnaround on available inventory**
- **8-hour average set up with on-site experts**
- **Comprehensive package, including pumps, flexible water piping connection and electrical hookups**

EQUIPMENT FOR PLANNED SITUATIONS

Forming a contingency plan in the event of an outage can help you quickly get operations back to normal and limit financial loss, and help you breathe easier when the unexpected happens. Selecting the right-sized equipment is just one part of the process. The best contingency plans start by assessing and understanding your financial risk, and then using this information to drive the rest of your plan. Our Rental Solutions experts can specify the supplemental cooling system required to support any situation you're experiencing.

- **System maintenance**
- **Building expansion**
- **Server room heat generation**
- **Seasonal/staff heat load swings**
- **Contingency plans**

SUPPLEMENTAL CAPACITY

When the demand of your facility or process exceeds your current system's capacity because of record-high temperatures or changes to cooling requirements, Daikin temporary rentals can be used to increase your heating or cooling output. By eliminating the need to purchase additional equipment that might be only used part of the year, you save on capital expenditures.

STANDBY

Standby for critical applications and processes is another efficient use for temporary rental equipment. A temporary system is sometimes used to back up manufacturing and chemical processes, or when a hospital's required system redundancy has been reduced.

COMPLETE HVAC SYSTEM SOLUTIONS

SELF-CONTAINED | ROOFTOPS | COILS | CONDENSING UNITS
AIR HANDLERS | WATER-COOLED CHILLERS | AIR-COOLED CHILLERS
MODULAR CENTRAL PLANTS | SITELINE BUILDING CONTROLS
UNIT HEATERS | FAN COILS | AIR PURIFIERS | WATER SOURCE HEAT PUMPS
VARIABLE AIR VOLUME UNITS | UNIT VENTILATORS



13600 INDUSTRIAL PARK BLVD. | MINNEAPOLIS, MN 55441
1-800-432-1342 | 763-553-5330

LEARN MORE AT
[DAIKINAPPLIED.COM](https://www.daikinapplied.com)