

VISION[®] / SKYLINE[®]

EC FAN CONTROLLER



MODELS: CAH, CAC, OAH, OAC

Safety Information	3	BMS Communications	27
Control Panel Locations	4	BACnet IP Setup	27
Controller Fundamentals	5	BACNet MSTP Setup	28
Getting Started	5	Service Menus	28
Passwords	5	Alarms	32
Navigation Mode	6	Other Menu Items	33
Edit Mode	6	About this Array	33
View Status	6	MicroTech Inputs/Outputs	34
Field Wired Inputs	7	Modbus Inputs/Outputs	35
Field Control Wiring	7	Keypad and Display	36
Fan Array Sensors	11		
Duct Pressure Sensor	11		
Ready Relay	12		
Running Relay	12		
Alarm Output	12		
Commissioning and Operations	13		
Array Set-Up	13		
Units	13		
Date/Time Settings	14		
Enable The Array	15		
Configure Array Menu	15		
Control Mode	15		
Digital Inputs	15		
CFM Sensor Setup	16		
Configure Fans	17		
Quick Menu	18		
Unit Status	20		
Fan Status	21		
Fan Menus	22		
Alarm Status	23		
Warn Status	24		
IO Status	25		
Other Configurations	26		
Damper Control	26		
Manual Array Operation	26		

©2026 Daikin Applied, Minneapolis, MN. All rights reserved throughout the world. This document contains the most current product information as of this printing. Daikin Applied Americas Inc. has the right to change the information, design, and construction of the product represented within the document without prior notice. For the most up-to-date product information, please go to www.DaikinApplied.com.

™ MicroTech and Daikin Applied are trademarks or registered trademarks of Daikin Applied Americas Inc. The following are trademarks or registered trademarks of their respective companies: BACnet from American Society of Heating, Refrigerating and Air-Conditioning Engineers, Inc.; Echelon, LonWorks, LonMark, and LonTalk from Echelon Corporation; Modbus from Schneider Electric; and Windows from Microsoft Corporation.

Safety Information

Hazard Identification

⚠ DANGER
Danger indicates a hazardous situation, which will result in death or serious injury if not avoided.

⚠ WARNING
Warning indicates a potentially hazardous situations, which can result in property damage, personal injury, or death if not avoided.

⚠ CAUTION
Caution indicates a potentially hazardous situations, which can result in minor injury or equipment damage if not avoided.

NOTICE
Notice indicates practices not related to physical injury.

NOTE: Indicates important details or clarifying statements for information presented in Figures or Tables.

General Information

This manual provides operating information about the Vision/ Skyline Daikin Applied EC Fan array with premium controls. This document includes controller operation sequences and start-up procedures. For overall array installation and/or maintenance procedures, refer to the following documents:

Table 1: Vision / Skyline Literature

Title	Literature Part Number
Vision CAC/CAH	IM 672
Vision Extended Sizes CAC/CAH	IM 915
Vision and Skyline Gas Heat	IM 1300
Skyline OAC/OAH	IM 777

Figure 1: Example Delta Motor Label

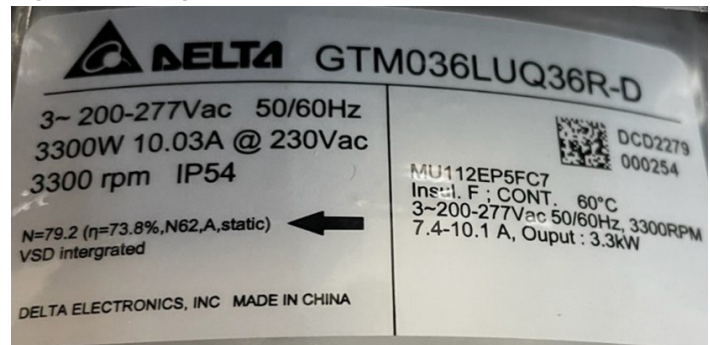

Figure 2: Example EBM Motor Label

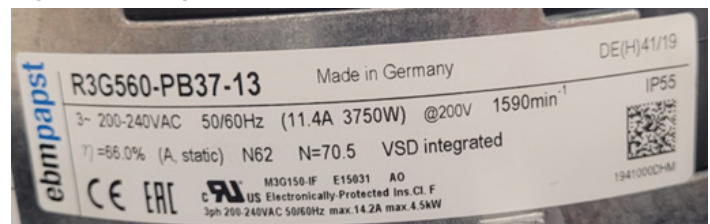

Figure 3: Example Infinitum Motor Label

<p>Conforms to UL STD 1004-1, 1004-7 & 61800-5-1 Certified to CSA STD C22.2#77, 100 & 274 MODEL# AEL4B20AS</p> <p>Intertek ETL #</p> <p>WARNING: The Infinitum motor is only intended for operation with the integrated drive. Do not operate this motor with any other VFD. AVERTISSEMENT: Le moteur Infinitum est uniquement conçu pour fonctionner avec le variateur intégré. N'utilisez pas ce moteur avec un autre VFD.</p> <p>Austin, TX, USA support.goinfinitum.com www.goinfinitum.com info@goinfinitum.com Manufactured in _____ S_____</p>	AIRCORE EC		
	SN: 0101SLT010001		REV: A
	INPUT: 575VAC 3Φ 60Hz		
	OUTPUT	RPM	AMP
1.7 - 10 HP 1.3 - 7.5 kW	360 - 2160	575V: 2.7 - 10	
910526491			
Input	SN		
575VAC 3Φ 60Hz	0101SLT010001		
OUTPUT	RPM	AMP	
10 HP / 7.5 kW	1800	10.0	
EFF. AMCA 207	SF 1.0	INS B	
ENC TEFC	CONT	IP54 E.P.L.	

Control Panel Locations

Figure 4 shows control and power panel locations on a typical section. Figure 5 and Figure 6 show the layout of the components within the power box and low voltage control box, respectively.

Figure 4: Panel Locations (Example)

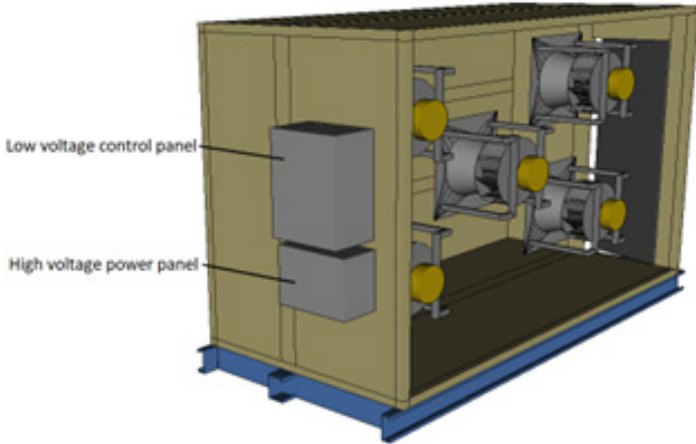

Figure 6: Low Voltage Control Panel (Example)

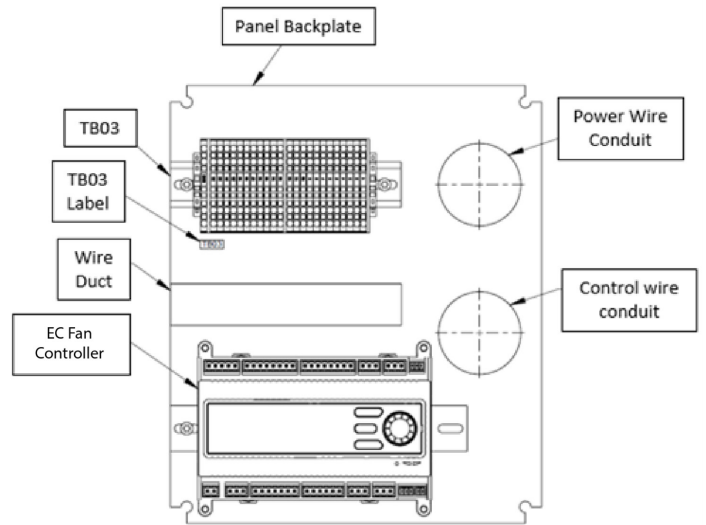
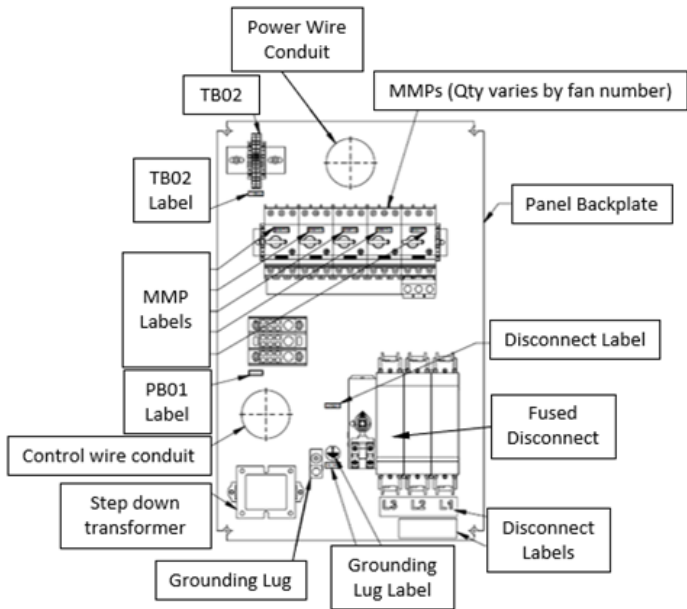

Figure 5: Power Box Control Panel (Example)



Controller Fundamentals

Getting Started

This manual contains information designed to assist the field technician with the Daikin Applied EC fan array setup when premium controls are provided. The technician will need to be familiar with the following topics at a minimum to successfully set up the Daikin Applied EC fan array operation.

- Keypad navigation/editing/passwords
- Control Mode
- Demand Source

The keypad/display consists of a 5-line-by-22-character display, three keys and a “push and roll” navigation wheel. There is an Alarm Button, Menu (Home) Button, and a Back Button. The wheel is used to navigate between lines on a screen (page) and to increase and decrease changeable values when editing. Pushing the wheel acts as an Enter Button.

The first line on each page includes the page title and the line number to which the cursor is currently “pointing”. The line numbers are X/Y to indicate line number X of a total of Y lines for that page. The left most position of the title line includes an “up” arrow to indicate there are pages “above” the currently displayed items, a “down” arrow to indicate there are pages “below” the currently displayed items or an “up/down” arrow to indicate there are pages “above and below” the currently displayed page.

Each line on a page can contain status only information or include changeable data fields. When a line contains status only information and the cursor is on that line all but the value field of that line is highlighted meaning the text is white with a black box around it. When the line contains a changeable value and the cursor is at that line, the entire line is highlighted. Each line on a page may also be defined as a “jump” line, meaning pushing the navigation wheel will cause a “jump” to a new page. An arrow is displayed to the far right of the line to indicate it is a “jump” line.

The keypad/display Information is organized into Menu groups; Main Menu, Quick Menu, View Status, Commission Array, Manual Control, Service Menus, BMS Communications, Alarm List, and About This Array.

NOTE: Only menus and items that are applicable to the specific array configuration are displayed.

The Main Menu allows the user to enter a password, access the Quick Menu pages, view the current array state, access the Alarm List Menu as well as access information about the fan array. The Quick Menu provides access to status information indicating the current operating condition of the fan array. The View Status Menus include basic fan array operating status menus and information about current operation. The Commission Array menu includes commissioning/configuration menus to set up the fan array for operation. The Manual Control Menu allows service personnel to test fan array operation directly from the HMI. The Service Menus allow service personnel to review Modbus status and current fan operation hours. The BMS Communications menus allow service personnel to view and set building management system parameters such as the IP address. The Alarm List Menu includes active alarm and alarm log information. The About This Array menu allows service personnel to view information about the fan array including SO Number and Software Build Version.

Passwords

Various menu functions are accessible or inaccessible, depending on the access level of the user, and the password they enter, if any. There are four access levels, including no password, Level 2, Level 4, and Level 6, with Level 2 having the highest level of access. Without entering a password, the user has access only to basic status menu items and the About this Array menu group. Entering the Level 6 password (5321) adds access to the Alarm List, Quick Menu, and the View Status menu groups to the “no password” level. Entering the Level 4 password (2526) adds access to the Service Menu and Manual Control menu groups to the Level 6 access level. Entering the Level 2 password (6363) adds access to the Commission Array and BMS Communications menu groups to the level 4 access level.

NOTE: Alarms can be acknowledged without entering a password.

The main menu is displayed when the keypad/display is first accessed, the Home Key is pressed, the Back Key is pressed multiple times, or if the keypad/display has been idle longer than the Password Timeout (default 10 minutes). The main menu provides access to enter a password, access the Quick Menu, view the current Array State, access the alarm lists or view information about the array.

Figure 7: Example Password Main Menu

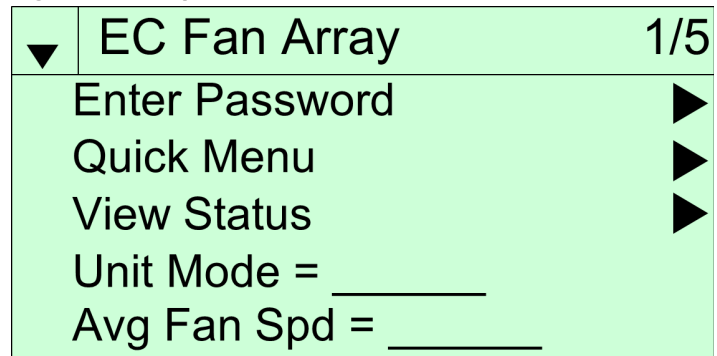

The password field initially has a value **** where each * represents an adjustable field. These values can be changed by selecting the Enter Password menu item.

Figure 8: Password Entry Page

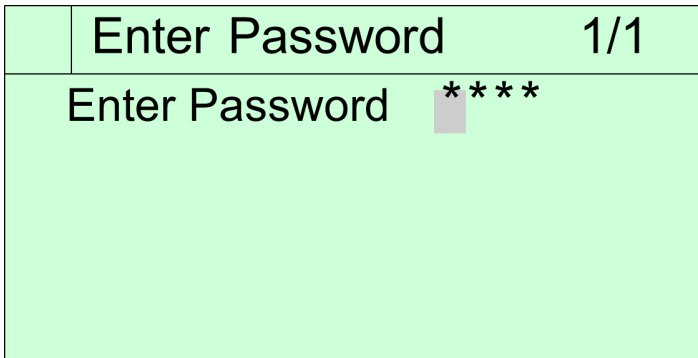

Entering an invalid password has the same effect as continuing without entering a password. Once a valid password has been entered, the controller allows further changes and access without requiring the user to enter a password until either the password timer expires or a different password is entered. The default value for this password timer is 10 minutes .

Navigation Mode

In the Navigation Mode, when a line on a page contains no editable fields, all but the value field of that line is highlighted, meaning the text is white with a black box around it. When the line contains an editable value field the entire line is inverted when the cursor is pointing to that line .

When the navigation wheel is turned clockwise, the cursor moves to the next line (down) on the page. When the wheel is turned counterclockwise the cursor moves to the previous line (up) on the page. The faster the wheel is turned the faster the cursor moves .

When the Back Button is pressed the display reverts to the previously displayed page. If the Back button is repeatedly pressed the display continues to revert one page back along the current navigation path until the “main menu” is reached.

When the Menu (Home) Button is pressed the display reverts to the “main page.”

When the Alarm Button is pressed, the most recent active alarm displays.

Edit Mode

The Editing Mode is entered by pressing the navigation wheel while the cursor is pointing to a line containing an editable field. Turning the wheel clockwise while the editable field is highlighted causes the value to be increased. Turning the wheel counterclockwise while the editable field is highlighted causes the value to be decreased. The faster the wheel is turned the faster the value is increased or decreased. Pressing the wheel again causes the new value to be saved and the keypad/display to leave the edit mode and return to the navigation mode.

View Status

The “View Status” menu provides a series of read-only menus to observe the status of individual fans, IO status, and the current date and time settings.

Field Wired Inputs

Field Control Wiring

After the array has been installed, EC Fan Arrays may require low voltage field wiring to connect the BMS to the EC fan controller, along with any additional sensors that may be required. Use the schematic provided on the door of the control panel to determine where field control connections required for the application are located. Figure 9 is a graphical representation of TB03, and Table 2 shows the possible field connections that can be made.

Figure 9: TB03 Sample Diagram

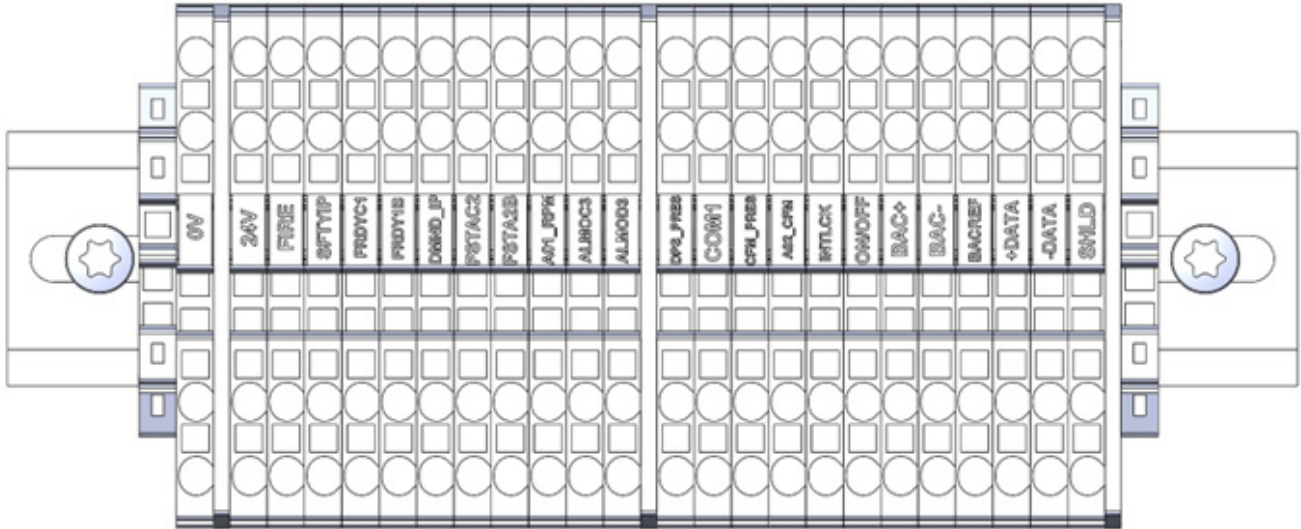

Table 2: Potential Field Connections and Locations on TB03 (Terminal Block Label 1 is Rightmost Terminal Block)

Terminal Block Label	Terminal Block Name	Description	Signal
1	SHLD	MODBUS to Fans	RS485
2	-DATA	MODBUS to Fans	RS485
3	+DATA	MODBUS to Fans	RS485
4	BACREF	BACnet Ground	RS485
5	BAC-	BACnet Negative	RS485
6	BAC+	BACnet Positive	RS485
7	ON/OFF	Array ON/OFF	Contact Closure
8	INTLCK	Interlock Input	Contact Closure
9	A02_CFM	CFM Output	0–10V DC
10	CFM_PRES	CFM Pressure Sensor	Configurable (4–20mA/0–10V)
11	COM1	DC Ground	GND
12	DPS_PRES	DSP Pressure Sensor	Configurable (4–20mA/0–10V)
13	ALMOD3	Alarm	Contact Closure
14	24VC3	Alarm	Contact Closure
15	A01_RPM	RPM Output	0–10V DC
16	24VC2	Fan Status	Contact Closure
17	FSTAC2	Fan Status	Contact Closure
18	DMND_IP	Demand Input	Configurable (4–20mA/0–10V)
19	FRDY1B	Fan Ready	Contact Closure
20	24VC1	Fan Ready	Contact Closure
21	SFTYIP	Safety Input	Contact Closure

Terminal Block Label	Terminal Block Name	Description	Signal
22	FIRE	Fire Mode Input	Contact Closure
23	24V	Power Supply	24V
GROUND	0V	GND	GND

Figure 10: System Block Diagram

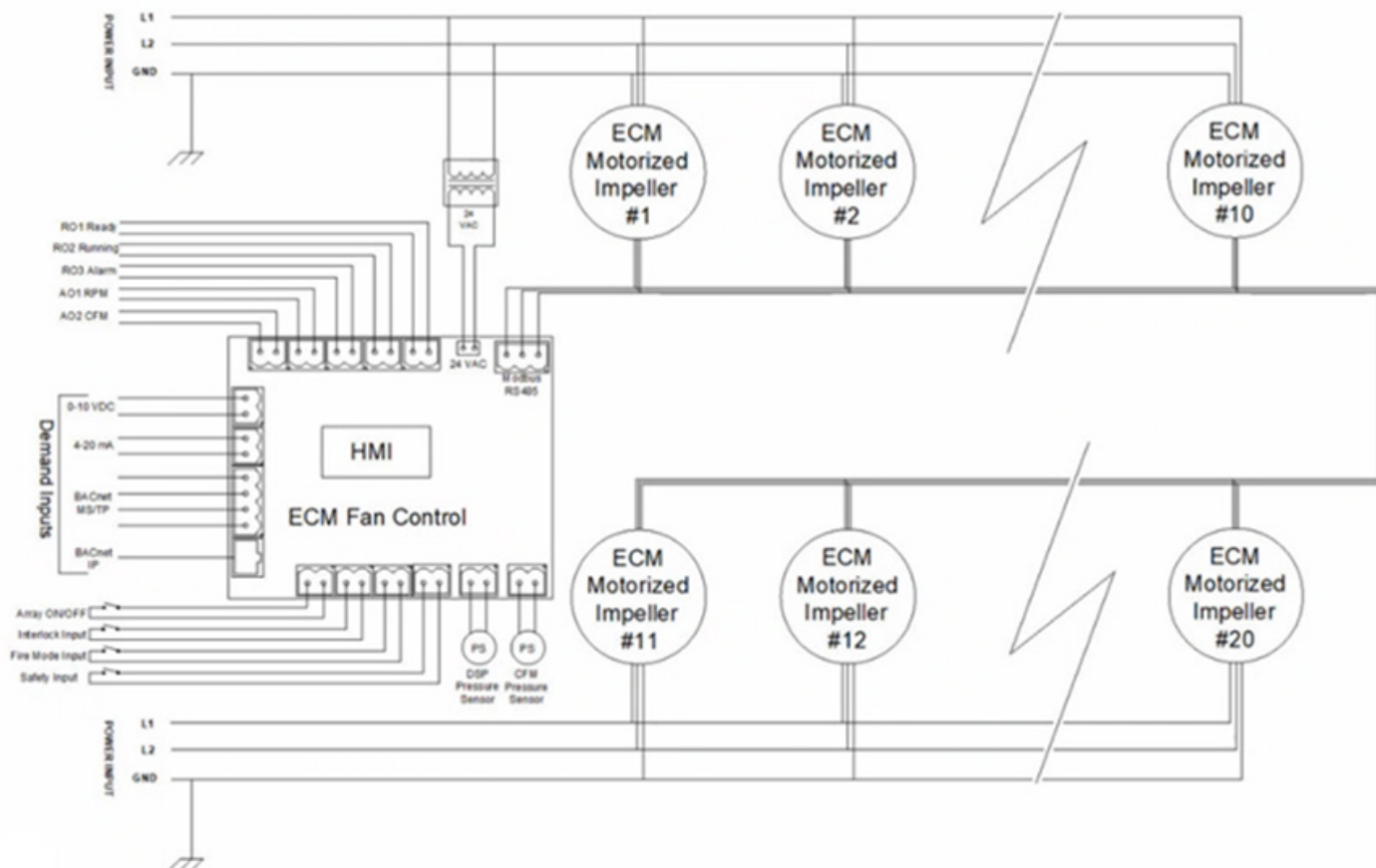
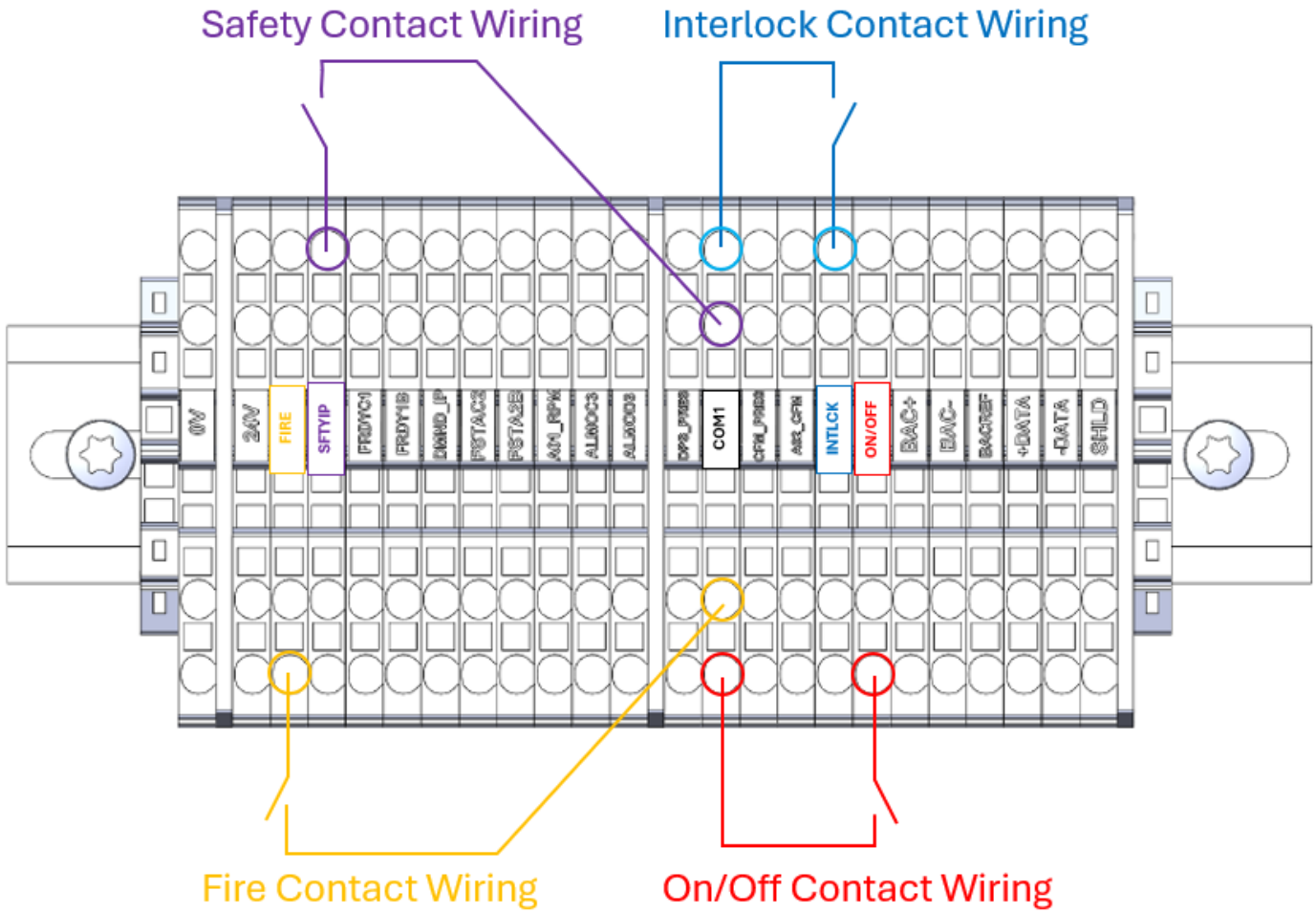
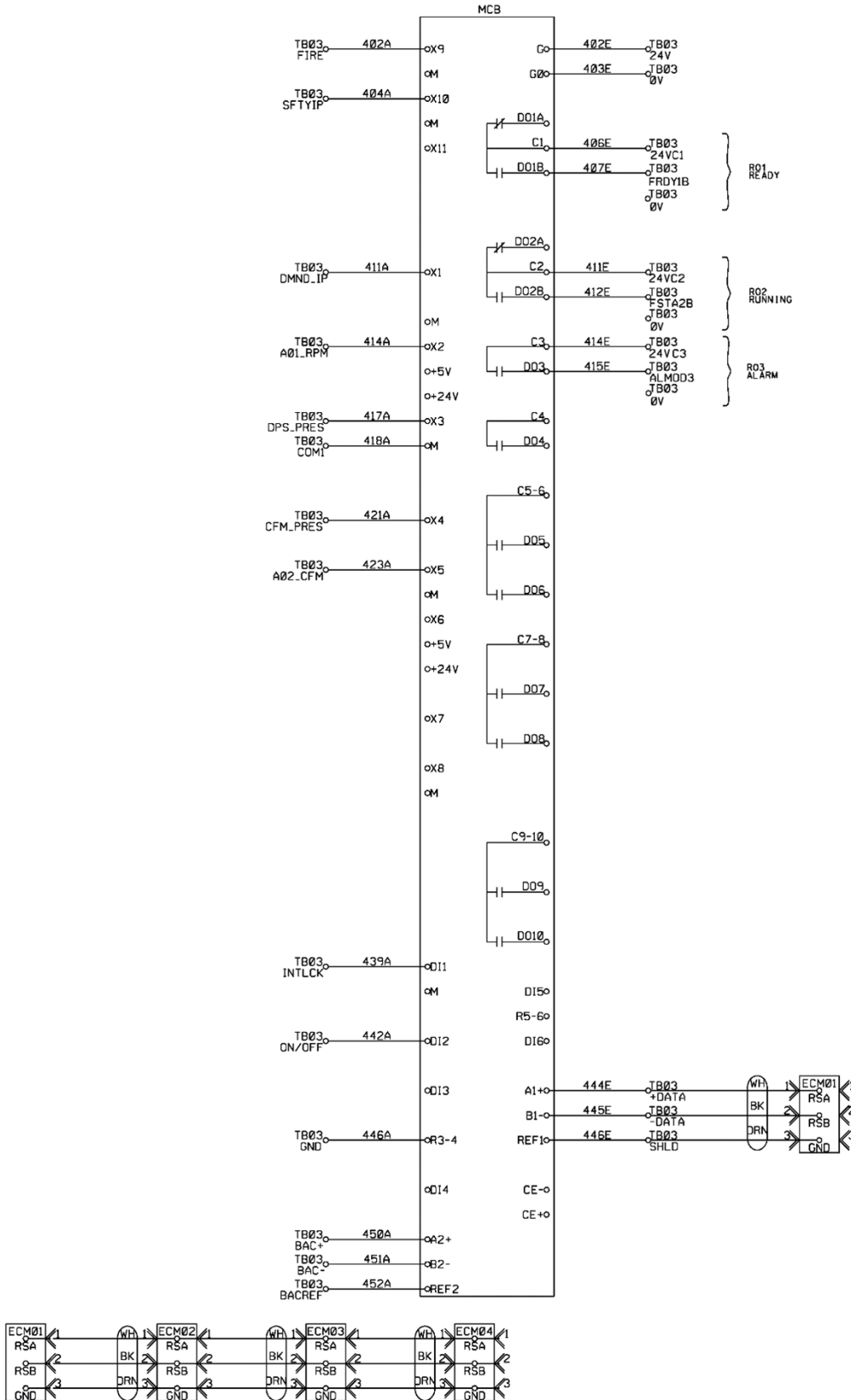

Figure 11: Field Control Wiring



NOTE: The diagram provided in Figure 11 is an example. Any open port on a terminal block can be utilized.

Figure 12: Example Control Schematic



Fan Array Sensors

The EC fan controller can be wired to the following sensors:

- Duct Pressure Sensor
 - Field-provided and -installed
- Array CFM Pressure Transducer (see page 16 for CFM sensor setup)
 - Factory Installed, Daikin Applied PNs: 2061282 -04 through -07
 - 1 transducer per array

Main Menu \ Commission Array \ Config Array \ DSPSenSetup			
Menu Display Name	Default	Range	Description
MaxDSP	10	0–10	MaxDSP is an adjustable item that informs the controller what the sensor's maximum pressure threshold is. Units are inches WC.

Duct Pressure Sensor

The Duct Pressure Sensor is used by the EC fan controller to calculate duct static pressure downstream of the fan. The Pressure Range Limit will be selected in the controller through the Main Menu\Commission Array\Configure Array\DSPSenSetup menu. The sensor measurement range can be entered into the controller in the Pressure Sensor Setup menu (up to 10" WC), and the pressure sensor output signal can be either in VDC or mA. The output range of the sensor can also be entered into the controller in the same menu.

Figure 13: Duct Pressure Sensor Schematic

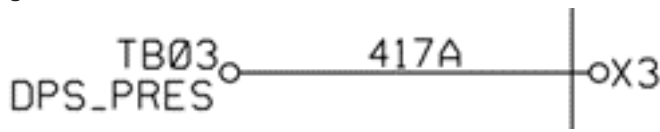

Table 3: Duct Pressure Sensor Navigation

Main Menu \ Commission Array \ Config Array \ DSPSenSetup			
Menu Display Name	Default	Range	Description
DSPSnsrTyp	mA	None mA VDC	DSPSnsrTyp is an adjustable item that selects the input signal type to the controller from the Duct Static Pressure sensor.
V/A@MinDSP	4(VDC) 4(mA)	0–10(VDC) 0–20(mA)	V/A@MinDSP is an adjustable item that informs the controller what the VDC or mA signal magnitude is at the sensor's minimum pressure threshold.
MinDSP	0	0–10	MinDSP is an adjustable item that informs the controller what the sensor's minimum pressure threshold is.
V/A@MaxDSP	10 (VDC) 20 (mA)	0–10(VDC) 0–20(mA)	V/A@MaxDSP is an adjustable item that informs the controller what the VDC or mA signal magnitude is at the sensor's maximum pressure threshold.

Ready Relay

The controller has a Ready Relay contact that provides a digital output that will close when the fan array is ready to run.

Figure 14: Ready Relay Schematic

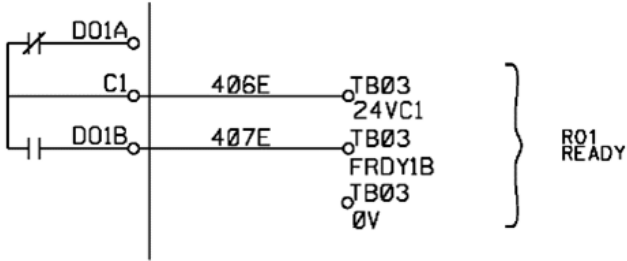

Running Relay

The controller has a Running Relay contact that provides a digital output that will close when the fan array receives a request to run from the specified demand input.

Figure 15: Running Relay Schematic

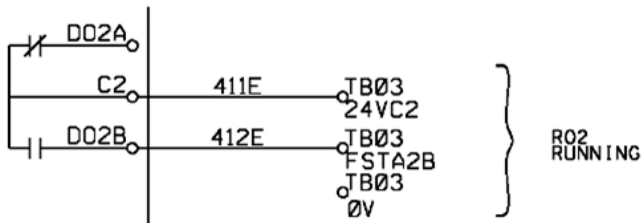

Alarm Output

The controller has an Alarm Output contact that provides a digital output anytime an alarm is active on the controller. The alarm output will close whenever there are any alarms on the EC fan controller.

Figure 16: Alarm Output Schematic

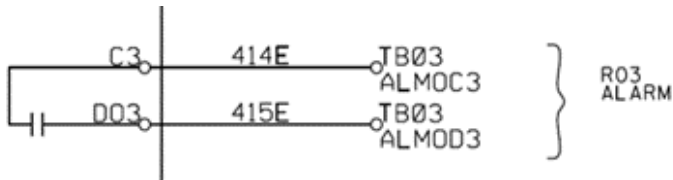

Commissioning and Operations

Array Set-Up

General array set-up configurations are used to adjust the controller's units of measure and the array name.

Table 4: Array Set-Up Menu

Main Menu \ Commission Array \ Array Set-Up			
Menu Display Name	Default	Range	Description
Eng Units	US	US SI CA	Unit of Measure is an adjustable item to indicate if the unit is to display US, Metric, or Canadian units of measure.
Name	-	-	Array Name is an adjustable item that allows each controller to be given a unique name. This may be useful when multiple arrays are connected to a single remote HMI. The limit for this value is 14 alphanumeric characters.

Units

The units of measure can be set to US, Metric, or Canadian units. For all units of measure, the units will be as shown in Table 5.

Table 5: Units of Measure

Unit of Measure	English Units	Metric Units	Canadian Units
Weight	lb	kg	kg
Temperature	°F	°C	°C
Airflow	ft ³ /min	m ³ /hr	ft ³ /min
Pressure	inWc	Pa	Pa
Electrical Power	kW	kW	kW
Length	ft	m	m

Date/Time Settings

The controller uses the date and time to timestamp events. The current time and date will not be lost if the array is turned off for up to forty-eight hours. The time and date can be set from the HMI. The time of day can be set by entering the hour (00–23), minute (00–59), and second (00–59) into the appropriate menu item. The current date can be set by entering the day (01–31), month (01–12) and year (2000–2050) into the appropriate menu item.

Table 6: Date/Time Menu

Main Menu \ Commission Array \ Array Set-up \ Date/Time Settings			
Menu Display Name	Default	Range	Description
Date	-	01.01.2000– 12.31.2050	Date is an adjustable item that details the current date
Time	-	00:00:00– 23:59:59	Time is an adjustable item that details the time
UTC Diff	6h	-12–14	UTC-difference is an adjustable parameter that can be set to indicate how the local time where the array is situated differs from the Coordinated Universal Time (adjustable in one hour increments).
DLSStartMonth	Mar	NA Jan–Dec	DLS Start Month is an adjustable item that sets the month for daylight savings time to begin.
DLSStartWeek	2ndWeek	1stWeek 2ndWeek 3rdWeek 4thWeek 5thWeek	DLS Strt Week is an adjustable item that sets the week of the month for daylight savings time to begin.
DLSEndMonth	Nov	NA Jan–Dec	DLS End Month is an adjustable item that sets the month for daylight savings time to end.
DLSEndWeek	1stWeek	1stWeek 2ndWeek 3rdWeek 4thWeek 5thWeek	DLS End Week is an adjustable item that sets the week of the month for daylight savings time to end.
DLSEnable	Enable	Disable Enable	DLS Enable is an adjustable item that sets whether daylight savings time is enabled.

Enable The Array

Configure Array Menu

The Configure Array Menu is a commissioning menu that provides adjustable parameters to set the fan operating controls.

Table 7: Configure Array Menu

Main Menu \ Commission Array \ Config Array			
Menu Display Name	Default	Range	Description
Ctrl Method	RPM	DSP RPM CFM Tracking	Ctrl Method is an adjustable item used to select how the fan array is to be controlled. The fan array can normally be controlled by a duct pressure (DSP), constant CFM setpoint (CFM), or RPM which allows the fans to either be set at constant speed or adjusted with a building automation system.
DmdSrc	0–10	4–20 mA 0–10 VDC BACnet HMI	DmdSrc is an adjustable item that defines the demand input source. The DmdSrc options available to select are contingent on the CtrlMode selected.
Fire EN	No	Yes No	Fire EN is an adjustable item that allows the controller to ignore the Fire Mode Input when set to “No.” When enabled, if a contact connected to this input is opened, all alarm contacts are closed and alarm signals are sent out through BACnet and the controller HMI.
IntLck EN	No	Yes No	IntLck EN is an adjustable item that allows the controller to ignore the Interlock Input when set to “No.” When enabled, this input delays fan operation until an external contact is closed.
Safety EN	No	Yes No	Safety EN is an adjustable item that allows the controller to ignore the Safety Input when set to “No.” When enabled, if a contact connected to this input is opened, the fan will not operate under any circumstances.
OnOff EN	No	Yes No	OnOff EN is an adjustable item allows the controller to ignore the Array ON/OFF Input when set to “No.” When enabled, this input allows the fan array operation to be controlled on/off with an external contact closure (closing this contact enables fan operation).

Control Mode

Daikin Applied EC fan arrays will be controlled using a factory EC motor for each fan. Each motor is controlled via a Modbus interface when selected with the premium control package.

The fan array will control between an adjustable minimum and maximum fan capacity. EBM fans have a minimum speed of 8% of maximum capacity while Delta fans have a minimum of 200 RPM fan speed. Maximum speed for both fan styles is 100% of fan capacity. The setpoints can be adjusted at the array controller interface or via a network input signal.

- **RPM Control (RPM):** An RPM control type controls the fan array capacity to a fixed speed value.
- **Duct Pressure Control (DSP):** Duct pressure control operates the array to maintain duct conditions. The fan array is modulated to maintain a duct static pressure setpoint, based on an external pressure sensor (field supplied and installed).
- **CFM Control:** The array is equipped with a fan airflow measuring system. When the array is configured to CFM control, the fan array capacity is modulated to maintain an adjustable airflow (CFM) setpoint.

Digital Inputs

The EC fan controller has several digital inputs: a Start Signal Input, an Interlock Input, a Fire Input, and an Alarm Enable Input. Inputs can be landed on terminal block TB03 inside the low voltage control box as shown in the master wiring diagram shown in “Field Wired Inputs” on page 7.

CFM Sensor Setup

The CFM Sensor Setup Menu allows the user to set the parameters for the specific sensor installed in the array. The Array CFM Pressure Transducer is used by the EC fan controller to calculate the total CFM delivered by the array. The Pressure Range Limit will be selected in the controller through the Main Menu\Commission Array\Config Array\CFMSenSetup menu. The sensor measurement range can be entered into the controller in the CFM Sensor Setup menu (up to 40" w.c.), and the pressure sensor output signal can be either in VDC or mA. The output range of the sensor can also be entered into the controller in the same menu.

Table 8: CFM Sensor Setup Menu

Main Menu \ Commission Array \ Config Array \ CFMSenSetup			
Menu Display Name	Default	Range	Description
CFMSnsrType	mA	None mA VDC	CFMSnsrType is an adjustable item that selects the input signal type to the controller from the CFM sensor.
V/A@MinCFMDP	4	0–20	V/A@MinCFMDP is an adjustable item that informs the controller what the VDC or mA signal magnitude is at the sensor's minimum pressure threshold.
MinCFM DP	0	0–40	MinCFM DP is an adjustable item that informs the controller what the sensor's minimum pressure threshold is.
V/A@MaxCFMDP	20	0–20	V/A@MaxCFMDP is an adjustable item that informs the controller what the VDC or mA signal magnitude is at the sensor's maximum pressure threshold.
MaxCFM DP	5	0–40	MaxCFM DP is an adjustable item that informs the controller what the sensor's maximum pressure threshold is.

Table 9: Pressure Range Limits for Daikin Applied Pressure Transducers

Daikin Applied PN	Pressure Range Limit
206128207	0–5" W.C.
206128204	0–10" W.C.
206128205	0–20" W.C.
206128206	0–40" W.C.

Figure 17: CFM Sensor Schematic

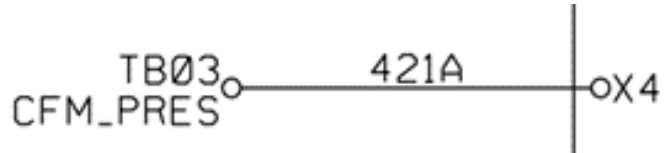

Configure Fans

The Configure Fans Menu allows the user to configure the fan-specific settings for the array.

Table 10: Configure Fans Menu

Main Menu \ Commission Array \ Config Fans			
Menu Display Name	Default	Range	Description
FanNumber	4	1–20	FanNumber is an adjustable item that informs the controller of the number of fans in the array.
Fan Supplier	Delta	EBM Delta Infin (9B) Infin (12B)	Fan Supplier is an adjustable item that informs the controller of the brand of fans installed in the array.
FanSize	355 mm	(EBM and Delta) 355 mm–630 mm (Infinitum) 11–36	FanSize is an adjustable item that informs the controller of the nominal diameter of the fan impellers installed in the array.
FanVoltage	460	208/230 460	FanVoltage is an adjustable item that informs the controller of the voltage of the fans installed in the fan array. Units are in VDC
FanPower	-	0.0 kW–15.0 kW	FanPower is an adjustable item that informs the controller of the nameplate power rating of the fans installed in the fan array.
IncTime	60 s	0–120s	IncTime is an adjustable item that controls the time it will take to change the fan speed from minimum RPM to maximum RPM.
DecTime	60 s	0–120s	DecTime is an adjustable item that controls the time it will take to change the fan speed from maximum RPM to minimum RPM.
MaxRPM	(EBM and Delta) 355 mm: 3300 450 mm: 2600 560 mm: 1900 630 mm: 1950 (Infinitum) 11–36: 0–4000	(EBM and Delta) 355mm: 0–3300 450mm: 0–2600 560mm: 0–1900 630mm: 0–1950 (Infinitum) 11-36: 0–4000	MaxRPM is an adjustable item that sets the maximum fan speed for the application. The controller adjusts the range of this value based on the fan impeller size selected. Units are in RPM.
Min(0%)RPM	0 RPM	(EBM and Delta) 355mm: 0–3300 450mm: 0–2600 560mm: 0–1900 630mm: 0–1950 (Infinitum) 11-36: 0–4000	Min(0%)RPM is an adjustable item that sets the minimum fan speed for the application. The controller adjusts the range of this value based on the fan impeller size selected. Units are in RPM.
VentOvrSpd	0 RPM	(EBM and Delta) 355 mm: 0–3300 450 mm: 0–2600 560 mm: 0–1900 630 mm: 0–1950 (Infinitum) 11–36: 0–4000	VentOvrSpd is an adjustable item that sets the fan speed when the vent limit is activated. The controller adjusts the range of this value based on the fan impeller size selected. Note that this value cannot exceed the MaxRPM value. Units are in RPM.
RPMFbErr	300 RPM	0–3000 RPM	RPMFbErr is an adjustable item that sets the maximum differential between the RPM setpoint and the actual RPM of the fans in the array. If this differential is exceeded, an alarm will be displayed.
AdptvSpd	Yes	Yes No	AdptvSpd is an adjustable item that enables or disables adaptive speed. If enabled, when a fan in the array is lost or disabled, the remaining fans will increase their RPM to compensate.

Quick Menu

Items in the Quick Menu contain basic array operating status and control set point parameters . The items shown in the Quick Menu are Read Only if a valid password has not been entered . The following are brief descriptions of the Quick Menu items .

Table 11: Quick Menu

Main Menu \ Quick Menu			
Menu Display Name	Default	Range	Description
Ctrl Mode	-	Off Normal Manual Emergency	CtrlMode is a read only item that displays the status of operation in which the array is currently operating. The array mode can be any of the status values shown.
Mode Status	-	Off	Mode Status is a read-only item that displays...
Unit Alm	No Alarm	No Alarm Fan #1 Alarm Fan #2 Alarm ... Fan #19 Alarm Fan #20 Alarm Sensor Error Fire Alarm External Safety Alarm Interlock Alarm Pressure Alarm	Unit Alm is a read only item which displays if, and what, alarm is active.
General Alm	Off	Off On	
HMI Cmd SP	0	0–100%	HMI Cmd SP is the demand speed setpoint when the demand source is set to “HMI”.
HMI Cmd SP	0	0–4000*	HMI Cmd SP is the demand speed setpoint when the demand source is set to “HMI”. Units are in RPM. *The maximum permissible fan speed is determined by the MxPrmFanSpd (see page 21).
Dmd SP	0	0–100%	Dmd SP is an adjustable item that sets the demand setpoint.
AF SP	0	0–1842249	AF SP is an adjustable item that sets the CFM setpoint. Units are in CFM.
DSP SP	0	0–10	DSP SP is an adjustable item that sets the duct static pressure setpoint when control mode is DSP. Units are in inches WC.
DSP	-	0–10	DSP is a read-only item that displays the duct static pressure status from the field installed sensor. Units are in inches WC.
DSP Alm SP	0.25	0–2	DSP Alm SP is an adjustable item that sets the maximum differential between the DSP setpoint and the actual DSP read by the field-installed sensor. If this differential is exceeded, an alarm will be displayed. Units are in inches WC.
DmdFanSpdCmd	0	0–100%	DmdFanSpdCmd is a read only item that displays the fan array speed demand setpoint as a percentage of max speed.
aDmdFanSpdCmd	0	0–3300	aDmdFanSpdCmd is a read only item that displays the fan array speed demand setpoint in RPM.
AvgFanSpdCmdFb	0	0–100%	AvgDmdFanSpdCmd is a read-only item that displays the average speed of all the fans operating in the fan array as a percentage of max speed.
AvgFanSpdFb	0	0–3300	AvgFanSpdFb is a read-only item that displays the average speed of all the fans operating in the fan array. Units are in RPM.
AirFI DP	0	0–40	AirFI DP is a read-only item that displays the static pressure differential reported by the airflow measurement sensor.
AirFI	0	0–1842249	AirFI is a read-only item that displays the calculated array total airflow as reported by the airflow measurement sensor. Units are in CFM.
AFRatioToMax	0	0–100%	AFRatioToMax is a read-only item that displays the calculated array total airflow as a percentage of the estimated maximum allowable airflow.

Main Menu \ Quick Menu			
Menu Display Name	Default	Range	Description
Intr Lck In	Off	Off On	Intr Lck In is a read-only item that displays the current state of the Interlock digital input.
Fire Alm In	Off	Off On	Fire Alm In is a read-only item that displays the current state of the Fire Alarm digital input.
Safety In	Off	Off On	Safety In is a read-only item that displays the current state of the Safety digital input.
Array ON/OFF	Off	Off On	Array ON/OFF is a read-only item that displays the current state of the array on/off digital input.
Array Power	0	0–75*	Array Power is a read-only item that reports the total power consumption of the fan array. Units are in kW. *Array power limits are variable by configuration.

Unit Status

The "Unit Status" menu provides a summary of basic array status and control items. This menu summarizes the current operating state of the array, giving the operating state the array is in, along with the current capacity level of that operating state.

Table 12: Main Menu \ View Status \ Unit Status

Main Menu \ View Status \ Unit Status			
Menu Display Name	Default	Range	Description
Ctrl Mode	-	Off Normal Manual Emergency	Ctrl Mode is a read only item that displays the status of operation in which the array is currently operating. The array mode can be any of the status values shown.
Mode Status	-	Off Normal Manual Manual Off	Mode Status is a read only item that displays the current fan operating mode.
Unit State	-	Off Ready Running Manual Alarm EmergeWRN	Unit State is a read only item that displays the current state of the array. The array state can be any of the values shown
Unit Alm	No Alarm	No Alarm Fan #1 Alarm Fan #2 Alarm ... Fan #19 Alarm Fan #20 Alarm Sensor Error Fire Alarm External Safety Alarm Interlock Alarm Pressure Alarm	Unit Alm is a read only item which displays if, and what, alarm is active.
Array ON/OFF	Off	Off On	Array ON/OFF is a read only item that displays the current state of the array on/off digital input
RO1 Ready	Off	Off On	RO1 Ready is a read only item displays the state of the Fan Ready relay
RO2 Running	Off	Off On	RO2 Running is a read only item that displays the state of the Fan Running relay
RO3 Alarm	Off	Off On	RO3 Alarm is a read only item that displays the state of the Fan Alarm relay
DSP	0	-	DSP is a read only item that displays the DSP pressure sensor reading
AirFI DP	0	0-40	AirFI DP is a read-only item that displays the static pressure differential reported by the airflow measurement sensor.
AirFI	-	-	Air FI is a read only item that displays the total airflow of the fan array in CFM

Fan Status

The Fan Status Menu displays the fan operation and the relevant current control parameters.

Table 13: Fan Status Menu

Main Menu \ View Status \ Fan Status			
Menu Display Name	Default	Range	Description
Fan Run Cmd	Off	On Off	Fan Run Cmd is a read only item that displays the fan array run command output.
DmdFanSpdCmd	-	0–100%	DmdFanSpdCmd is a read only item that displays the fan array speed command output.
aDmdFanSpdCmd	-	0–4000	aDmdFanSpdCmd is a read only item that displays the fan array speed. Units are in RPM.
AvgFanSpdCmdFb	-	0–100%	AvgFanSpdFb is a read only item that displays the average speed command of all fans in the fan array.
AvgFanSpdFb	-	0–3300	AvgFanSpdFb is a read only item that displays the average speed of all fans in the array in RPM.
Max RPM	-	0–4000*	Max RPM is an adjustable setpoint for setting the maximum fan speed. Units are in RPM. *The maximum permissible fan speed is determined by the MxPrmFanSpd.
MxPrmFanSpd	-	0–4000	MxPrmFanSpd is a read only item that reports the maximum allowable fan speed as determined by the fan motor.
AirFI DP	-	0.0–40.0	AirFI DP is a read only item that displays the CFM pressure.
AirFI	-	0–200,000	Air FI is a read only item that displays the total airflow of the fan array in CFM
MxRPMFAF	-	0–200,000	MxRPMFAF is a read only item that reports the calculated theoretical maximum airflow of the entire array at maximum RPM.
AFRatioToMax	-	0–100%	AFRatioToMax is a read only item that displays the ratio of current airflow to the theoretical maximum airflow of the entire array at maximum RPM.
# Active Fans	-	0–20	# Active Fans is a read only item that displays the number of active fans in the fan array.
IntLck	Off	On Off	IntLck is a read only item that reports the status of the interlock.
IntLckTm	180.0	0–180.0	IntLckTm is an adjustable item that sets the maximum time the controller will wait before triggering the IntLckAlm.
IntLckAlm	Off	On Off	IntLckAlm is a read only item that reports that the expected time elapsed for the interlock signal to be received by the controller has exceeded the IntLckTm setting.
DSP	-	0–10	DSP is a read-only item that displays the duct static pressure status from the field installed sensor. Units are in inches WC.
DSP Alm	-	OK FLT	DSP Alm is a read-only item that displays the alarm status of the duct static pressure sensor. A fault will trigger if the sensor's reading is above or below the allowable deadband for over 60 seconds. See page 17 for details on the DSP alarm setpoint (DSP Alm SP).

Fan Menus

The Fan Menus display each individual fan operation status.

Table 14: Fan Menus

Main Menu \ View Status \ Fan Status \ Fan# (1-20)			
Menu Display Name	Default	Range	Description
Model	-	-	Model is a read only item that displays the motor model number.
SN	-	-	SN is a read only item that displays the fan motor serial number.
Run Hrs	-	-	Run Hrs is a read only item that displays the runtime of the fan in hours.
RPMAlm	-	OK Fit	RPMAlm is a read only item that displays whether there is a RPM alarm present.
ComErr	-	OK Fit	ComErr is a read only item that displays whether there is a communication error present.
Mtr Sts	-	OK Fit	Mtr Sts is a read-only item that displays whether a fault status exists on the motor.
AlmCode	Online	-	AlmCode is a read only item that displays the alarm code active (if any), otherwise will display "Online".
Modlvl	-	0–100%	Modlvl is a read only item that displays the modulation level.
SpdFb	-	0–4000*	SpdFb is a read only item that displays the RPM feedback from the motor. *The maximum permissible fan speed is determined by the MxPrmFanSpd (see page 21).
MaxRPM	-	0–4000*	MaxRPM is a read only item that displays the maximum RPM of the motor. *The maximum permissible fan speed is determined by the MxPrmFanSpd (see page 21).
MaxPermRPM	-	0–4000*	MaxPermRPM is a read-only item that displays the maximum permissible RPM of the motor. *The maximum permissible fan speed is determined by the MxPrmFanSpd (see page 21).
Pwr	-	-	Pwr is a read only item that displays the motor power.
MdlT	-	-	MdlT is a read only item that displays the winding temperature within the motor.
MtrT	-	-	MtrT is a read only item that displays the motor temperature.
ElcT	-	-	ElcT is a read only item that displays the temperature of the internal electronics.
Direction	CW	CW CCW	Direction is a read only item that displays the rotational direction setting of the fan wheel.
DCLink_VRef	-	-	DCLink_VRef is a read only item that displays the DC Link reference voltage.
Voltage	-	-	Voltage is a read only item that displays the motor voltage.
DCLink_CRef	-	-	DCLinkCRef is a read only item that displays the DC Link reference current.
Current	-	-	Current is a read only item that displays the motor current.

Alarm Status

The Alarm Status Menu displays alarm information for individual fans. Damage could occur if any alarms are ignored.

Table 15: Alarm Status Menu

Main Menu \ View Status \ Fan Status \ Fan# (1-20) \ Alarm Status			
Menu Display Name	Default	Range	Description
PHA	Inactive = 0	Active = 1 Inactive = 0	PHA is the phase failure (3-phase devices) or line undervoltage (single-phase devices) alarm for EBM fans
TFE	Inactive = 0	Active = 1 Inactive = 0	TFE is the output stage overheating alarm for EBM fans
SKF	Inactive = 0	Active = 1 Inactive = 0	SKF is the communication error between master controller and slave controller alarm for EBM fans
FB	Inactive = 0	Active = 1 Inactive = 0	FB is the fan bad alarm, which is a general error for EBM fans
TFM	Inactive = 0	Active = 1 Inactive = 0	TFM is the motor overheating alarm for EBM fans
HLL	Inactive = 0	Active = 1 Inactive = 0	HLL is the hall sensor error alarm for EBM fans
BLK	Inactive = 0	Active = 1 Inactive = 0	BLK is the motor blocked alarm for EBM fans
n_Limit	Inactive = 0	Active = 1 Inactive = 0	n_Limit is the speed limit exceeded alarm for EBM fans
RL_Cal	Inactive = 0	Active = 1 Inactive = 0	RL_Cal is the rotor position sensor calibration error alarm for EBM fans
UzLow	Inactive = 0	Active = 1 Inactive = 0	UzLow is the DC-link undervoltage alarm for EBM fans
OC	Inactive = 0	Active = 1 Inactive = 0	OC is the DCbus average over protection current alarm for Delta fans
OV	Inactive = 0	Active = 1 Inactive = 0	OV is the DCbus average over protection voltage alarm for Delta fans
UV	Inactive = 0	Active = 1 Inactive = 0	UV is the DCbus average under protection voltage alarm for Delta fans
OT	Inactive = 0	Active = 1 Inactive = 0	OT is the EE over protection temperature alarm for Delta fans
Lock	Inactive = 0	Active = 1 Inactive = 0	Lock is the fan lock alarm for Delta fans
PL	Inactive = 0	Active = 1 Inactive = 0	PL is the 3~ AC lose phase alarm for Delta fans
RRW	Inactive = 0	Active = 1 Inactive = 0	RRW is the fan reverse run alarm for Delta fans
Hall	Inactive = 0	Active = 1 Inactive = 0	Hall is the hall signal abnormal alarm for Delta fans
EEPROM	Inactive = 0	Active = 1 Inactive = 0	EEPROM is the EEPROM read/write fail alarm for Delta fans
POC	Inactive = 0	Active = 1 Inactive = 0	POC is the DCbus peak over current alarm for Delta fans
AC_OV	Inactive = 0	Active = 1 Inactive = 0	AC_OV is the AC bus over protection voltage alarm for Delta fans
AC_UV	Inactive = 0	Active = 1 Inactive = 0	AC_UV is the AC bus under protection voltage alarm for Delta fans

Warn Status

The Warn Status Menu displays warning information for individual EBM fans. Damage could occur if any warnings are ignored.

Table 16: Warn Status Menu

Main Menu \ View Status \ Fan Status \ Fan# (1-20) \ Warn Status			
Menu Display Name	Default	Range	Description
I_Limit	Inactive = 0	Active = 1 Inactive = 0	I_Limit is the current limitation is engaged
L_High	Inactive = 0	Active = 1 Inactive = 0	L_High is the line impedance too high (DC-link voltage unstable)
P_Limit	Inactive = 0	Active = 1 Inactive = 0	P_Limit is the power limiter is currently engaged
TE_high	Inactive = 0	Active = 1 Inactive = 0	TE_high is the output stage temperature is high
TM_High	Inactive = 0	Active = 1 Inactive = 0	TM_High is the motor temperature is high
TEI_high	Inactive = 0	Active = 1 Inactive = 0	TEI_high is the temperature inside electronics is high
UzLow	Inactive = 0	Active = 1 Inactive = 0	UzLow is the DC-link voltage is low
LRF	Inactive = 0	Active = 1 Inactive = 0	LRF is shedding function is active
Brake	Inactive = 0	Active = 1 Inactive = 0	Brake is triggered in instances where an external force causes the fan/motor to run in the wrong direction at high speed for a prolonged period of time, so the motor is unable to start properly
UzHigh	Inactive = 0	Active = 1 Inactive = 0	UzHigh is the DC-link voltage is high
UeHigh	Inactive = 0	Active = 1 Inactive = 0	UeHigh is the line voltage is high
RL_Cal	Inactive = 0	Active = 1 Inactive = 0	RL_Cal is the calibration of the rotor position sensor is in progress
Op_circ	Inactive = 0	Active = 1 Inactive = 0	Op_cir is triggered when the analog input voltage is less than the open circuit limit value
n_Low	Inactive = 0	Active = 1 Inactive = 0	n_Low is the actual speed is less than the speed limit set for speed monitoring

IO Status

The IO Status Menu displays the status of all the I/O variables.

Table 17: IO Status Menu

Main Menu \ View Status \ IO Status			
Menu Display Name	Default	Range	Description
Array ON/OFF	Off	On Off	Array ON/OFF is a read only item that displays the current state of the array on/off digital input.
Demand Input	0	0–100%	Demand Input is a read only item that displays the fan array speed command input.
DSP Press Snsr	0	-	DSP Press Snsr is a read only item that displays the DSP pressure sensor reading.
AF DPSnsr	0	-	AF DPSnsr is a read only item that displays the airflow pressure sensor reading.
Interlock Input	Off	On Off	Interlock Input is a read only item that displays the interlock switch status.
Safety Input	Off	On Off	Safety Input is a read only item that displays the external safety alarm input status.
Fire Mode Input	Off	On Off	Fire Mode Input is a read only item that displays the fire alarm input status.
On Off Input	Off	On Off	On Off Input is a read only item that displays the status of the Array On/Off input.
RO1 Ready	Off	On Off	RO1 Ready is a read only item displays the state of the Fan Ready relay.
RO2 Running	Off	On Off	RO2 Running is a read only item that displays the state of the Fan Running relay.
RO3 Alarm	Off	On Off	RO3 Alarm is a read only item that displays the state of the Fan Alarm relay.
AO1 RPM	0%	0–100%	AO1 RPM is a read only item that reports the RPM value being sent from the controller to the fans in the array.
AO2 CFM	0%	0–100%	AO2 CFM is a read only item that reports the CFM value being sent from the controller to the fans in the array.

Other Configurations

Damper Control

When the array is equipped with a set of dampers, the damper can be set up with an end switch that is connected to the EC fan controller Interlock Input. This can be used to signal the controller that the damper is in the proper position for fan startup. The RO2 Running can also be used to send a command signal to the damper actuator(s) to adjust the damper(s) between two positions. Reference the Field Control Wiring section of this OM for specific control locations on TB03. Refer to the “Field Wired Inputs” chapter for more information.

Manual Array Operation

Manual Control can be initiated during start up to control individual features of the fan array independent of the control sequence. Place the array into Manual Control mode through the controller keypad menu Main Menu\Manual Control\Manual Mode = Manual. Once in manual control, fans can be activated manually.

NOTE: Manual Operation is not intended for extended operation beyond troubleshooting or initial start-up. After 60 minutes, the controller will automatically revert to normal operation.

Table 18: Manual Control Menu

Main Menu \ Manual Control			
Menu Display Name	Default	Range	Description
Manual Mode	Normal	Off Normal Manual	Manual Mode is an adjustable item that allows the array to be placed in normal mode, manual control mode, or turned off completely.
Count Down	0	0–60 min	Count Down is a ready only item that reports how many minutes are left before the controller reverts back to normal operation.
Manual Speed	0%	0–100%	Manual Speed is an adjustable item that manually drives the array to a specified capacity.
AvgFanSpd	-	0–4000* RPM	AvgFanSpd is a read only item that reports the average speed of all fans in the array. *The maximum permissible fan speed is determined by the MxPrmFanSpd (see page 21).
Intr Lck In	Off	On Off	Intr Lck In is a read only item that displays the interlock switch status.
Safety In	Off	On Off	Safety In is a read only item that displays the external safety alarm input status.
Fire Alm In	Off	On Off	Fire Alm In is a read only item that displays the fire alarm input status.
Array ON/OFF	Off	On Off	Array ON/OFF is a read only item that displays the status of the Array On/Off input.
RO1 Ready	On	Off On	RO1 Ready is an adjustable item that sets the output to the Ready Relay (A value of On here will close the contact).
RO2 Running	On	Off On	RO2 Running is an adjustable item that sets the output to the Running Relay (A value of On here will close the contact).
RO3 Alarm	Off	Off On	RO3 Alarm is an adjustable item that sets the output to the Alarm Relay (A value of On here will close the contact).
AO1 RPM	0%	0–100%	AO1 RPM is an adjustable item that sets the RPM value being sent from the controller to the fans in the array.
AO2 CFM	0%	0–100%	AO2 CFM is an adjustable item that sets the CFM value being sent from the controller to the fans in the array.
Clear Alarms	No	Yes No	Clear Alarms is an adjustable item will reset all alarms on the controller when set to Yes.

BMS Communications

Reference ED Protocol Document – ED 19122 Vision ECM Fan Controller for additional detail on BMS Communications.

BACnet IP Setup

Table 19: BACnet T-IP Menu

Main Menu \ BMS Communications \ BACnet T-IP			
Menu Display Name	Default	Range	Description
Name	MT4_DFA_#### '####' is the instance ID	-	Up to a 13 Character Device Object Name. This value is read-only.
Dev Instance	####, default is the last 4 digits of the serial number	0-4294967	Device Instance of the BACnet communication module
UDP Port	47808	0-65535	UDP Port is the User Datagram Protocol. The UDP Port allows host to host communication via the IP network and is used to identify the application process in the destination array. Only change the UDP Port if there are multiple subnets. See a network administrator before modification.
DHCP	Off	On Off	DHCP is the Dynamic Host Configuration Protocol. The DHCP is a network protocol that enables a server to automatically assign an IP Address. Set to Off if a static IP address is needed.
ActIP	0.0.0.0	-	ActIP Is a read-only item that displays the active IP Address of the BACnet Communication module.
ActMask	0.0.0.0	-	ActMask is a read-only item that displays the active Subnet Base of the BACnet Communication Module.
ActGwy	0.0.0.0	-	ActGwy is a read-only item that displays the active gateway address.
GvnIP	127.0.0.1	-	GvnIP is an adjustable item to set the IP Address of the BACnet Communication module.
GvnMask	255.255.255.0	-	GvnMsk is an adjustable item to set the Subnet Base of the BACnet Communication Module
GvnGwy	127.0.0.1	-	GvnGwy is an adjustable item to set the gateway address.
Unit System	US	SI US CA	Unit System is an adjustable item to indicate if the BACnet communication uses US, Metric, or Canadian units of measure.
Save Config	No	No Yes	Save Config saves the configuration changes made in the menu items above

BACnet MSTP Setup

Table 20: BACnet MS/TP Menu

Main Menu \ BMS Communications \ BACnet MS/TP			
Menu Display Name	Default	Range	Description
Name	MT4_DFA_#### ##### is the instance ID	-	Up to a 13 Character Device Object Name. This value is read-only.
Dev Instance	#####, default is the last 4 digits of the serial number	0-4294967	Device Instance of the BACnet communication module
MSTP Address	18	0-429	This is the MST/TP address of the BACnet communication module.
Baud Rate	38400	9600 19200 38400 57600 76800 115200	Baud Rate is an adjustable item that is the Data Transfer speed.
Max Master	127	1-127	Max Master is an adjustable item that specifies the highest possible address for master nodes and shall be less than or equal to 127.
Max Info Frm	10	1-127	Max Info Frm is an adjustable item that specifies the maximum number of information frames the BACnet communication module may send before it must pass the token.
BACnetOverRS485	Passive	Active Passive	BACnetOverRS485 is an adjustable item that enables BACnet MSTP communication to the controller. This should be set to Passive if BACnet IP is used, Active if BACnet MS/TP is used.
Unit System	US	SI US CA	Unit System is an adjustable item to indicate if the BACnet communication uses US, metric, or Canadian units of measure.
Save Config	No	No Yes	Save Config saves the configuration changes made in the menu items above

Service Menus

The Service Menus section covers several menus that will be useful while maintaining the equipment.

Fan Service

Table 21: Fan Service Menu

Main Menu \ Service Menus \ Fan Service			
Menu Display Name	Default	Range	Description
ArrayOp Hrs	-	--	ArrayOp Hrs indicates the number of run hours on the array
ArrayCyc Cnt	-	--	ArrayCyc Cnt indicates the number of operational cycles on the array (number of times the array has been started/stopped)

Operating Hours

Table 22: Operating Hours Menu

Main Menu \ Service Menus \ Fan Service \ Fan Op Hours			
Menu Display Name	Default	Range	Description
Fan1	-	0-999,999h	Fan Hours is a status only item that displays the number run hours on the Fan
Fan2	-	0-999,999h	Fan Hours is a status only item that displays the number run hours on the Fan
...	-	0-999,999h	Fan Hours is a status only item that displays the number run hours on the Fan
FanXX (max 20 fans)	-	0-999,999h	Fan Hours is a status only item that displays the number run hours on the Fan

Modbus

The Modbus menu is to be used for addressing the fans in the field.

Figure 18: Modbus Menu

Main Menu \ Service Menus \ Modbus			
Menu Display Name	Default	Range	Description
Fan1CommStat	-	Fault OK	Fan1CommStat is a status only item that displays the current communication status for fan 1
Fan2CommStat	-	Fault OK	Fan2CommStat is a status only item that displays the current communication status for fan 2
FanXX (max 20 fans)	-	Fault OK	FanXXCommStat is a status only item that displays the current communication status for fan XX
ModbusResistor	-	0 × 0000	ModbusResistor indicates the bus pull up/pull down resistor, termination resistor configuration
DefaultECMStat	-	No Yes N/A	DefaultECMStat indicates if there is a fan with a default factory address available
ChngECMTo	Default	Default 1–20	ChngECMTo is an adjustable item that sets which master fan address will be changed to during the field addressing process
ChngECMFrom	Default	Default 1–20	ChngECMFrom is an adjustable item that sets which master fan address will be changed from during the field addressing process
Save Config	No	No Yes	Save Config saves the configuration changes made in the menu items above
ChndIDly	25 mSec	0–1000 mSec	ChndIDly is an adjustable item that sets the Modbus port release timeout delay on inactivity. Units are in milliseconds.
ChndIRSPTMO	250 mSec	0–1000 mSec	ChndIRSPTMO is an adjustable item that sets the Modbus response timeout delay. Units are in milliseconds.

To address the fans in the field, follow the procedure below:

1. Ensure the controller has power (requires a 24V power supply if not powered from the transformer in the fan array power box).
2. Ensure the fan(s) have power - the fans can be powered one at a time, or the whole array can be powered simultaneously. If powered individually, the fans need a minimum of 15W @ 110V single phase power in order to be addressed.
3. Confirm that the array is configured for the correct number of fans in the fan service menu (Main Menu \ Commission Array \ Config Fans)
4. Disconnect the modbus communication harnesses from all of the fans in the array except for one (ideally the fan closest to the control panel), leaving that fan connected to the MT4 controller.
5. Navigate back to the Modbus menu (Main Menu \ Service Menus \ Modbus), and check to see if the fan is ready to be addressed – the DefaultECMStat should show “Yes” and all FanCommStat variables should say “Flt”.

6. Reference the fan arrangement label (example shown below) to determine the fan number being addressed.

Figure 19: Fan Arrangement Diagram

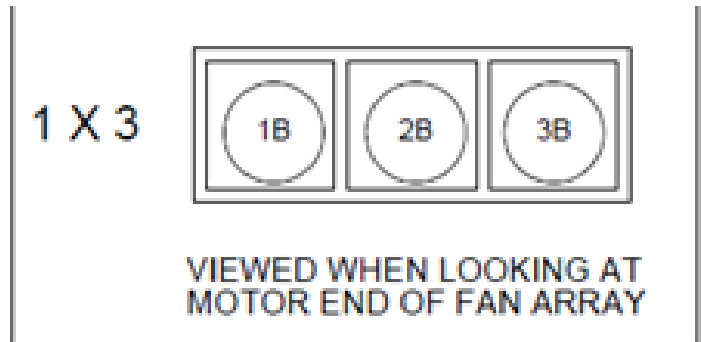

7. Set ChngECMTo to be the number of the fan to be addressed, and set ChngECMFrom to “Default”.
8. Set Save Config to “Yes”. After a short delay, the FanCommStat entry corresponding to the fan being addressed should change from Flt to OK.
9. Cycle power to the fan that was just addressed (or the entire array), then cycle power to the EC Fan Controller.
10. The next fan to be addressed can be connected back into the Modbus control “daisy chain”.
11. Repeat steps 5-10 until all fans have been addressed.

Air Flow

The Air Flow menu is used to define the constants utilized when the fan array control mode is constant CFM. These values are used with the pressure sensor on the leading fan to calculate the airflow. The fan array total airflow is then calculated by multiplying the calculated airflow by the quantity of running fans. "Altitude" is the only field set item in this menu. The other variables are defined by other parameter inputs – e.g. fan size.

Table 23: Air Flow Settings Menu

Main Menu \ Service Menus \ Air Flow Settings			
Menu Display Name	Default	Range	Description
Altitude SP	0	0–8,000 ft	Altitude SP is an adjustable item that determines the altitude-related parameters of unit operation. The Altitude SP should be set to the altitude of where the unit is intended to operate.
AltFactor (AF)	-	0.70–1.00	AltFactor (AF) is the altitude factor, dependent on the defined altitude.
FreeInlet (C1)	-	N/A	C1 is the coefficient factor for free and ducted inlet, using the standard density method for calculating airflow. The value depends on the impeller size of the fan.
Area (A)	-	N/A	Area (A) is the inlet funnel area as determined by the fan impeller size.
AirFICalAdj	0%	-99%–99%	AirFICalAdj is an adjustable item that allows for calibration of the calculated airflow from the differential pressure measured by the airflow sensor.
AirFI DP	0	0–40	AirFI DP is a read-only item that displays the static pressure differential reported by the airflow measurement sensor.
AirFI	-	0–200,000 CFM	AirFI is the calculated airflow of the array.
MxRPMFAF	-	N/A	MxRPMFAF is the theoretical maximum airflow at the maximum fan speed with no static pressure.
AFRatioToMax	-	0–100%	AFRatioToMax is the ratio between the calculated airflow of the array divided by the theoretical maximum airflow.

DSP Control

Table 24: DSP PID Settings Menu

Main Menu \ Service Menus \ DSP PID Settings			
Menu Display Name	Default	Range	Description
DSP Period	5.0 s	0–100.0 s	DSP Period is an adjustable item that sets the "sample time" used in the PI control function to vary the fan capacity when duct static pressure (DSP) control is selected.
DSP Gain	0.2	0.0–100.0	DSP Gain is an adjustable item that sets the "gain" used in the PI control function to vary the fan capacity when duct static pressure (DSP) control is selected.
DSP PAT	0.0 s	0.0–100.0 s	DSP PAT is an adjustable item that sets the "project ahead time" used in the PI control function to vary the fan speed when DSP Control is selected .
DSP MaxChg	1.0%	0.0–100.0%	DSP MaxChg is an adjustable item that sets the maximum value of increase or decrease of the fan capacity each period used in the PI control function to vary the fan capacity when duct static pressure (DSP) control is selected .
DSPDeadBand	0.1 in Wa	0.0–0.5 in Wa	DSPDeadBand is an adjustable item that defines the deadband range for the DSP control setpoint (DSP SP) within which the DSP PID control loop will remain unchanged.
DSP Alm SP	0.25 in Wa	0.00–2.00 in Wa	DSP Alm SP is an adjustable item that determines the deadband for the duct pressure alarm fault parameter. If the duct pressure sensor returns a pressure reading outside of this deadband, a fault will occur.

CFM Control

Table 25: CFM PID Settings Menu

Main Menu \ Service Menus \ CFM PID Settings			
Menu Display Name	Default	Range	Description
CFMPeriod	20.0 s	0.0–100.0 s	CFMPeriod is an adjustable item that sets the "sample time" used in the PI control function to vary the supply fan speed when CFM control is selected.
CFMGain	0.1	0.0–100.0	CFMGain is an adjustable item that sets the "gain" used in the PI control function to vary the supply fan speed when CFM control is selected.
CFMPAT	0.0 s	0.0–100.0 s	CFMPAT is an adjustable item that sets the "project ahead time" used in the PI control function to vary the fan speed when CFMControl is selected .

Main Menu \ Service Menus \ CFM PID Settings			
Menu Display Name	Default	Range	Description
CFMMxChg	2.0%	0.0–100.0%	CFMMxChg is an adjustable item that sets the maximum value of increase or decrease of the supply fan speed each period used in the PI control function to vary the supply fan speed when CFM control is selected.
CFMDeadBand	3%	0–100%	CFMDeadBand is an adjustable item that defines the deadband range for the CFM control setpoint (AF SP) within which the CFM PID control loop will remain unchanged.

Alarms

Alarms provide the user with information about abnormal conditions that affect array operation. The cause of the alarm should be investigated and eliminated before the array or any disabled equipment in it is placed back into service.

Viewing Alarms

The Active Alarms menu displays up to 10 active alarms and is located in the menu at Main Menu \ Alarm List \ Active Alarms.

Pushing the scroll wheel in, will show details about the alarm as well as when it occurred. "Alarms" (located in the menu at Main Menu \ Alarm List \ Alarms), shows the same information, but up to 50 of the latest alarms both active and previous alarms.

All active alarms as well as the priority and date and time that they were detected are displayed on the Active Alarm menu. The last fifty alarm "events" detected as well as the date and times that they were detected are displayed on the Alarm Log menu . An alarm "event" is either an alarm becoming active or being cleared . A "+" symbol precedes the active alarm event and a "-" symbol precedes the cleared alarm event. These alarms are displayed in the order that they were detected. The alarm that was detected most recently is displayed first. Multiple occurrences of the same alarm may appear.

Table 26: Example Active Alarms Menu

Main Menu \ Alarm List \ Active Alarms	
Alm Ct	Displays the number of active alarms.
Alarms	Submenu to examine the specific active alarms.
Clear Alarms =	Adjustable item to remove all active alarms. Set to "Yes" to reset the alarm count.

Other Menu Items

About this Array

Table 27: About this Array Menu

Main Menu \ About This Array			
Menu Display Name	Default	Range	Description
Array Name	-	-	Array Name is an adjustable field that allows the user to name the fan section
SO_Item	-	-	SO_Item displays the array order number and is programmed from the factory
Array SN	-	-	Array SN displays the array serial number and is programmed from the factory
App Version	-	-	App Version displays the installed version of the controller software code
Main BSP	-	-	Main BSP displays the installed version of the controller operating system
HMI GUID	-	-	HMI GUID displays the installed version of the controller HMI
OBH GUID	-	-	OBH GUID displays the installed version of the controller OBH

MicroTech Inputs/Outputs

The complete set of Inputs and Outputs that are possible on a Vision EC Fan Controller are listed below.

Table 28: Main Control Board

I/O Location	Description	I/O Type	I/O Voltage	Comments
D1	Interlock Input	DI	Dry Contact	Optional, if it's available, ON- Ready, OFF-Not ready;
D2	Array ON/OFF	DI	Dry Contact	Optional, if it's available, ON- Start, OFF-Stop;
DU1	Spare	DI	24 VAC Active DI	
DU2	Spare	DI	24 VAC Active DI	
DL1	Spare	DI	110 VAC Active DI	
DL2	Spare	DI	110 VAC Active DI	
X1	Demand Input	AI	0–10 V/4–20 mA	Depending on control method, auto configured based on control method and control source.
X2	AO1 RPM	AO	0–10 V Output	RPM output, fan speed command sending to the secondary controller.
X3	DSP Pressure Sensor	AI	0–10 V/4–20 mA	DSP pressure sensor, sensor signal type as well as sensor scaling shall be done in sensor config menu.
X4	CFM Pressure Sensor	AI	0–10V/4–20mA	CFM pressure sensor signal type as well as sensor scaling shall be done in sensor config menu.
X5	AO2 CFM	AO	0–10 V Output	CFM output.
X6	Spare	XIO		
X7	Spare	XIO		
X8	Spare	XIO		
X9	Fire Mode Input	XI	Dry Contact	Optional, if it's available, ON- alarm, OFF-OK.
X10	Safety Input	XI	Dry Contact	Optional, if it's available, ON- alarm, OFF-OK.
X11	Spare	XI		
Q1	RO1 Ready	DO	Relay Output	
Q2	RO2 Running	DO	Relay Output	
Q3	RO3 Alarm	DO	Relay Output	
Q4	Spare	DO	Relay Output	
Q5	Spare	DO	Relay Output	
Q6	Spare	DO	Relay Output	
Q7	Spare	DO	Relay Output	
Q8	Spare	DO	Relay Output	
DO1	Spare	DO	TRAIC	
DO2	Spare	DO	TRAIC	
Ethernet Port	BACnet IP		IP Port	Need to enable/config manually by technician.
T6	BACnet MSTP		RS485	Need to enable/config manually by technician.
T14	ECM Fan Modbus Control		RS485	Enabled by default.

Modbus Inputs/Outputs

The EC fans in the array are controlled via an RS-485 bus built into the array controller using Modbus protocol.

Figure 20: Modbus Network Configuration Diagram

Modbus Network Configuration

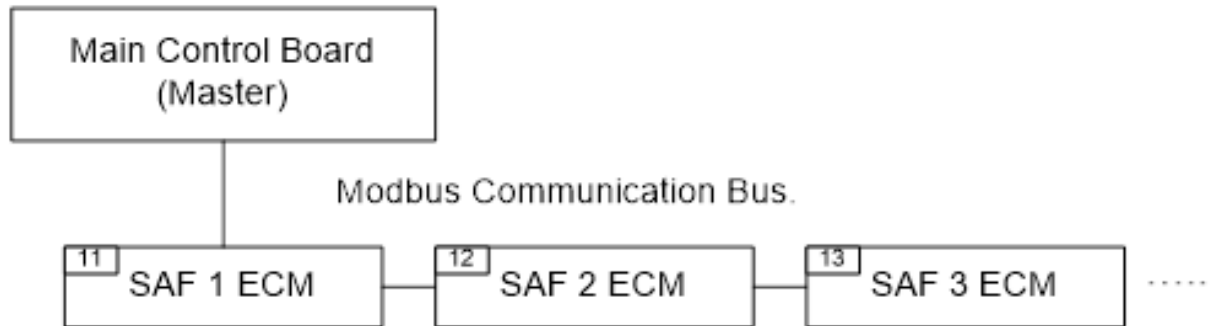

Keypad and Display

The following is a description of the Vision/Skyline Fan-Only Controller menu structure. These menus and items can all be viewed on the keypad/display. Menu items displayed will change based on the array configuration.

Figure 21: Keypad Key

=>	Indicates Entry Field
(X)	= RPM-BN or CFM or DSP
(L)	= Visible when user logged in
(S)	= See Config Array Settings

Figure 22: Display Menu (1)

Main Menu		Enter Password	
	Enter Password	Login	****(L)
(L)	Quick Menu	(L) Quick Menu	
(L)	View Status	Ctrl Mode =	Off
(L)	Ctrl Mode =>	Mode Status =	Off
	Mode Status =	Unit Alm =	No Alarm
	Unit State =	General Alm =	Off
(I)	Intr Lck In =	HMI Cmd SP =>	0.0 %
(F)	Fire Alm In =	HMI Cmd SP=>	0RPM
(S)	Safety In =	(X) Dmd SP =>	0 %
(O)	Array ON/OFF =	(D) DSP SP =>	0 inW
(L)	HMI Cmd SP =	(C) CFM SP =>	0 cfm
(X)	Dmd SP =	(R) Dmd Input SP =	0.0 %
(D)	DSP SP =	DmdFanSpdCmd =	0.0 %
(C)	CFM SP =	aDmdFanSpdCmd =	0 RPM
	Dmd Input SP =	AvgFanSpdCmdFb=	0.0 %
	DmdFanSpdCmd =	AvgFanSpdFb =	0 RPM
	aDmdFanSpdCmd =	AirFI DP =	0.0 inW
	AvgFanSpdCmdFb=	AirFI =	0 cfm
	AvgFanSpdFb=	AFRatioToMax =	40.3%
	Array Power =	(I) Intr Lck In =	Off
	DSPressure =	(F) Fire Alm In =	Off
	Air FI =	(S) Safety In =	Off
	AFRatioToMax=	(O) Array ON/OFF =	Off
	Clear Alarm =>	Array Power =	0.000kW
(L)	Commission Array	(D) DSPressure =	0.00 inW
(L)	Manual Control	(D) DSP Alm SP =>	0.00 inW
(L)	Service Menus		
(L)	BMS Communications	(L) Alarm List	
(L)	Alarm List	Active Alarm	
	About This Unit	Alarm Log	
About This AHU		(L) Active Alarm	
Name=>	Vision	Alm Ct: xx Clr Alms: No	
SO_Item=>	1234567_12345	Clr Alms: Alarm	
Unit SN=>	FBOU123456789	Alarms	
App Version=	2506990xxx	Alarms	
Main BSP=	xx.xx	(L) Alarm Log	
HMI GUID=	xxxxxxxx-xxxx-xxxx-xxxx-xxxxxxxxxxxx	Log Ct:	
OBH GUID=	xxxxxxxx-xxxx-xxxx-xxxx-xxxxxxxxxxxx	Log Clr:	
		Alarm Log	
		Alarm Log	

Figure 23: Display Menu (2)

<p>View Status</p> <ul style="list-style-type: none"> Unit Status Fan Status IO Status 	<p>Fan Status</p> <ul style="list-style-type: none"> Fan Run Cmd = Off DmdFanSpdCmd = 0.0 % aDmdFanSpdCmd = 0 RPM DmdFanSpdCmd = 0 RPM AvgFanSpdCmdFb = 0.0 % AvgFanSpdFb = 0 RPM MxPrmFanSpd = 2600 RPM Air FI DP = 0.0 inW AirFI = 0 cfm MaxAF@MaxRPM = 0 cfm AFRatioToMax = 0.0 % # Active Fans = 4 IntLck = Off IntLckTm => 180s IntLckAlm = Off DSPressure = 0.00 inW DSPHiAlm = OK Fan1 Fan2 Fan3 Fan4 	<p>Fan #</p> <ul style="list-style-type: none"> PN = GMT036PUQ36R D SN = Run Hrs = 0 Alarm Status Warn Status RPMAIm = OK CommErr = OK MtrFITsts = OK Mtr Sts = OK WarnCode = AlmCode = Online Modlvl = 0.0% SpdFb = 0 RPM MaxRPM = 2600RPM MaxPermRPM = 2600RPM Pwr = 0 W DC Link (V) = 0 V DC Link (I) = 0 A ModuleT = 0 F ElecT = 0 F MtrT = 0 F 	<p>Alarm Status</p> <ul style="list-style-type: none"> Code = PHA = TFE = SKF = TFM = HLL = BLK = n_Limit = TFEI = RL_Cal = UzHigh = UzLow = UeHigh = UeLow = Code = OC = OV = UV = OT = Lock = PL = RRP/RRW = Hall = EEPROM = POC = AC_OV = AC_UV =
<p>Unit Status</p> <ul style="list-style-type: none"> Ctrl Mode = Off Mode Status = Off Unit State = Off Unit Alm = Off 	<p>Manual Control</p> <ul style="list-style-type: none"> Manual Mode => Normal Count Down = 0Min Manual Speed => 0.0% AvgFanSpd = 0RPM Digital Input Sts: Intr Lck In = On Fire Alm In = On Safety In = On Array ON/OFF = On Digital/Analog Outputs: RO1 Ready => Off RO2 Running => Off RO3 Alarm => Off AO1 RPM => 0.0% AO2 CFM => 0.0% Clear Alarms => No 	<p>IO Status</p> <ul style="list-style-type: none"> Array ON/OFF = Off Demand Input = % DSP Press Snsr = 0.0 inW AirFICFM DPSnsr = 0.0 inW Interlock Input = Off Fire ModelInput = Off On Off Input = Off RO1 Ready = Off RO2 Running = Off RO3 Alarm = Off AO1 RPM = 0 % AO2 CFM = 0.0 % 	<p>Fan1 Warn</p> <ul style="list-style-type: none"> Code = I_Limit = L_high = P_Limit = TE_high = TM_High = TEI_high = LRF = Brake = UzHigh = UzLow = UeHigh = UeLow = RL_Cal = Op_circ = n_Low =
<p>BMS Communications</p> <ul style="list-style-type: none"> BACnet T-IP Setup BACnet MS/TP Setup 	<p>Fan20</p>		
<p>BACnet T-IP Setup</p> <ul style="list-style-type: none"> Name = MT4_DFA_1542 Dev Instance => 15422 UDP Port => 47808 DHCP => Off ActIP 192.168.1.42 ActMask 255.255.255.0 ActGwy 192.168.1.1 Gvn IP => 192.168.1.42 GvnMask => 255.255.255.0 GvnGwy => 192.168.1.1 Enable => Passive UnitSystem => US Save Config => No 			
<p>BACnet MS/TP Setup</p> <ul style="list-style-type: none"> Name = MT4_DFA_1542 Dev Instance => 15422 MSTP-Address => 18 Baud Rate => 38400 MaxMaster => 127 Max Info Frm => 10 BACNetOverRS485 => Active UtilitySystem => US Save Config => No 			

Figure 24: Figure Display (3)

Ⓛ	Commission Array
	Config Array ▶
	Config Fans ▶
	Array Set-up ▶
	SaveCfg = No
Ⓛ	Config Array
	Ctrl Method => RPM Ⓡ
	Ctrl Method => CFM Ⓒ
	Ctrl Method => DSP Ⓓ
	Ctrl Method => Tracking Ⓣ
	DmdSrc => 0-10V Ⓥ
	DmdSrc => 4-20mA Ⓐ
	DmdSrc => BACnet Ⓝ
	DmdSrc => HMI Ⓜ
Ⓣ	Fan Tracking ▶
Ⓓ	DSPSenSetup ▶
	CFMSenSetup ▶
	Fire En => ⓕ
	IntLck En => Ⓡ
	Safety En => Ⓢ
	OnOff En => Ⓣ
Ⓛ	Config Fans
	FanNumber => 4
	Fan Supplier => Delta
	FanSize => 355
	FanVoltage => 460V
	FanPower => 1.7kW
	DecTime => 60.0s
	IncTime => 60.0s
	Max RPM => 2600RPM
	Min (0%) RPM => 0RPM
	VentOverSpd => 0RPM
	RPMFbErr => 300RPM
	AdptvSpd => No
Ⓛ	Array Set-up
	Eng Units => US
	Name => Vision Skyline
	Date/Time Settings ▶
	Date Time
	Date => 05.22.2024
	Time => 09:20:28
	UTC Diff => 360min
	DLSSstartMonth Mar
	DLSSstartWeek 2ndWeek
	DLSEndMonth Nov
	DLSEndWeek 1stWeek
	DLSEnable Enable
Ⓣ	Tracking Config
	Set Tracking Min ▶
	Set Tracking Max ▶
Ⓣ	Set Tck Min
	SetTckMin => No
	MinRPMtck => 0RPM
	SaveTckData => No
Ⓣ	Set Tck Max
	SetTckMax => No
	MaxRPMtck => 2600RPM
	SaveTckData => No
	DSPSenSetup
	SDPSnsrType = mA
	V/A@MinPressDSP = 4.0
	MinPressDSP = 0.0inWa
	V/A@MaxPressDSP = 20
	MaxPressDSP = 20.0inWa
Ⓛ	CFMSenSetup
	CFMSnsrType = mA
	V/A@MinPressCFM = 4.0
	MinPressCFM = 0.0inWa
	V/A@MaxPressCFM = 20
	MaxPressCFM = 20.0inWa

Figure 25: Keypad Display (4)

Service Menu		Op Settings		AirFlwSettings	
Fan Service	▶	OffDlyWOIntrk =>	30s	Altitude SP =>	0ft
Operational Settings	▶▶	OffDlyWIntrk =>	30s	AltFactor(AF)	1.000
Modbus	▶▶▶	AutoStrtDly =>	5s	C1	774.47
Air Flow Settings	▶▶▶▶			Area	0.458sq.ft
DSP PID Settings	▶▶▶▶▶			AirFl	0cfm
CFM PID Settings	▶▶▶▶▶▶			AirFIRel	%
Fan Service		Modbus		DSP PID Loop	
ArrayOp Hrs =	0h	Fan1ComStat =	OK	DSPPeriod	2.0s
ArrayCyc Cnt =	0	Fan2ComStat =	OK	DSPGain	1.0
Fan Op Hours	▶	Fan3ComStat =	OK	DSPPAT	10.0s
		Fan4ComStat =	OK	DSPMaxChg (%)	2.0
		Fan5ComStat =	OK	DSPDeadBand	2.0%
		Fan6ComStat =	OK		
		Fan7ComStat =	OK	CFM PID Loop	
		Fan8ComStat =	OK	CFMPeriod	2.0s
		Fan9ComStat =	OK	CFMGain	1.0
		Fan10ComStat =	OK	CFMPAT	10.0s
		Fan11ComStat =	OK	CFMMaxChg (%)	2.0
		Fan12ComStat =	OK	CFMDeadBand	2.0%
		Fan13ComStat =	OK		
		Fan14ComStat =	OK		
		Fan15ComStat =	OK		
		Fan16ComStat =	OK		
		Fan17ComStat =	OK		
		Fan18ComStat =	OK		
		Fan19ComStat =	OK		
		Fan20ComStat =	OK		
		MB Resis =>	0x0000		
		DfltECMStat =	Fit		
		ChngECMTo =>	Default		
		ChngECMFrom =>	Default		
		Save Config=>	No		
		ChndIDly =>	25		
		ChndIRSPTMO =>	250		

Figure 26: Navigation Wheel

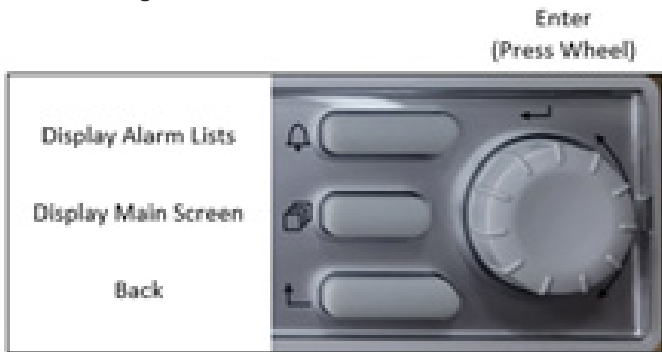

Turn wheel to scroll up and down menu or to change values

This navigation map represents all possible Fan Array menus and menu items. Not all menus and items shown here will appear on the HMI display depending on the specific Fan Array configuration. Those that do not appear are not applicable to this Array.

COMPLETE HVAC SYSTEM SOLUTIONS

SELF-CONTAINED | ROOFTOPS | COILS | CONDENSING UNITS
AIR HANDLERS | WATER-COOLED CHILLERS | AIR-COOLED CHILLERS
MODULAR CENTRAL PLANTS | CONNECTED BUILDING CONTROLS
UNIT HEATERS | FAN COILS | AIR PURIFIERS | WATER SOURCE HEAT PUMPS
VARIABLE AIR VOLUME UNITS | UNIT VENTILATORS



13600 INDUSTRIAL PARK BLVD. | MINNEAPOLIS, MN 55441
1-800-432-1342 | 763-553-5330

LEARN MORE AT
DAIKINAPPLIED.COM

PART NUMBER: OM1329

© 2026 DAIKIN APPLIED | (800) 432.1342 | WWW.DAIKINAPPLIED.COM