

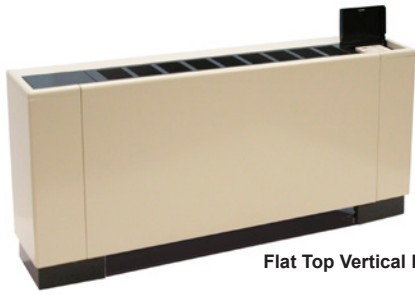
## ThinLine Vertical Fan Coils

Type FCVC, FCVH, FCVS Vertical Design



<b>Nomenclature and Certification</b> . . . . .	<b>3</b>	<b>Performance Data</b> . . . . .	<b>15</b>
ThinLine Vertical Fan Coils . . . . .	3	Two-Pipe Systems - Hot Water Heat . . . . .	15
<b>Overview</b> . . . . .	<b>4</b>	Four-Pipe Systems - Hot Water Preheat (1 or 2 row) or Reheat (1 row) . . . . .	16
The ThinLine Advantage . . . . .	4	Four-Pipe Systems - Steam Preheat or Reheat . . . . .	17
<b>Features and Benefits</b> . . . . .	<b>5</b>	Air Volume Capacity Data . . . . .	18
<b>Options and Accessories</b> . . . . .	<b>6</b>	<b>Electrical Data</b> . . . . .	<b>19</b>
Control Options . . . . .	6	Electric Heaters . . . . .	19
Unit Accessories . . . . .	8	Motor Electrical Data . . . . .	20
Factory Valve & Piping Packages . . . . .	10	<b>Physical Data</b> . . . . .	<b>21</b>
Control Valve Options . . . . .	12	Unit Data . . . . .	21
<b>Unit Selection</b> . . . . .	<b>14</b>	<b>Physical Data</b> . . . . .	<b>21</b>
		Unit Dimensions . . . . .	22
		Decorative Wall Plate Dimensions . . . . .	26
		Fresh Air Intake Box Dimensions . . . . .	26
		<b>Guide Specification</b> . . . . .	<b>27</b>

## ThinLine Vertical Fan Coils

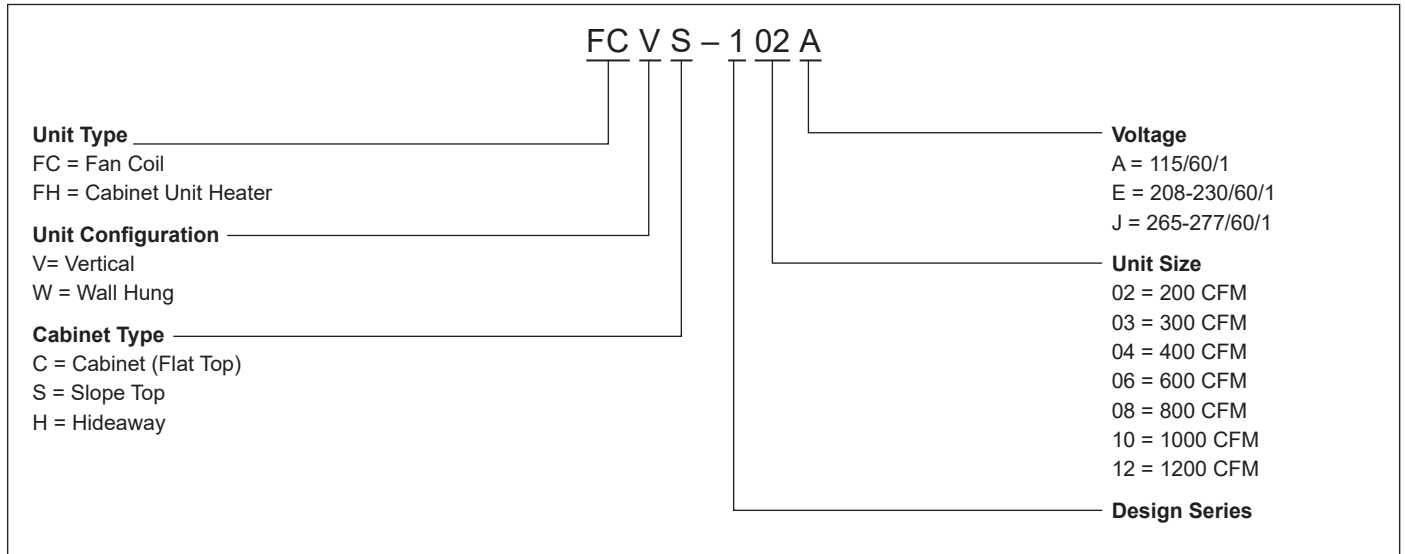


Flat Top Vertical Fan Coil



Slope Top Vertical Fan Coil

**Figure 1: Nomenclature**



### AHRI Certification



Standard size units certified in accordance with the Room Fan-Coil Unit certification program, which is based on AHRI Standard 440.

### Agency Listed



All standard units  
All Canadian units

## The ThinLine Advantage

New ThinLine vertical fan coils combine the features most desired in a fan coil by building owners, specifying engineers and contractors alike. The result is a new, third generation fan coil design that meets the needs of all three.

### For building owners

ThinLine fan coils offer quiet operation. They fully comply with [ASHRAE 62.1-2004](#) standards for high indoor air quality. And they offer a range of control options that can enhance occupant comfort and reduce operating costs. These units are also easy to maintain, with easy access to filters, fan motors and control systems. Heavier-gauge panels and locked control compartments for tamper-proof style cabinets are available. A total of five color options, both as standard and special requests are available for a variety of decor styles.

### For specifying engineers

ThinLine fan coils provide great versatility. A variety of vertical models are available with multiple arrangements and configurations.

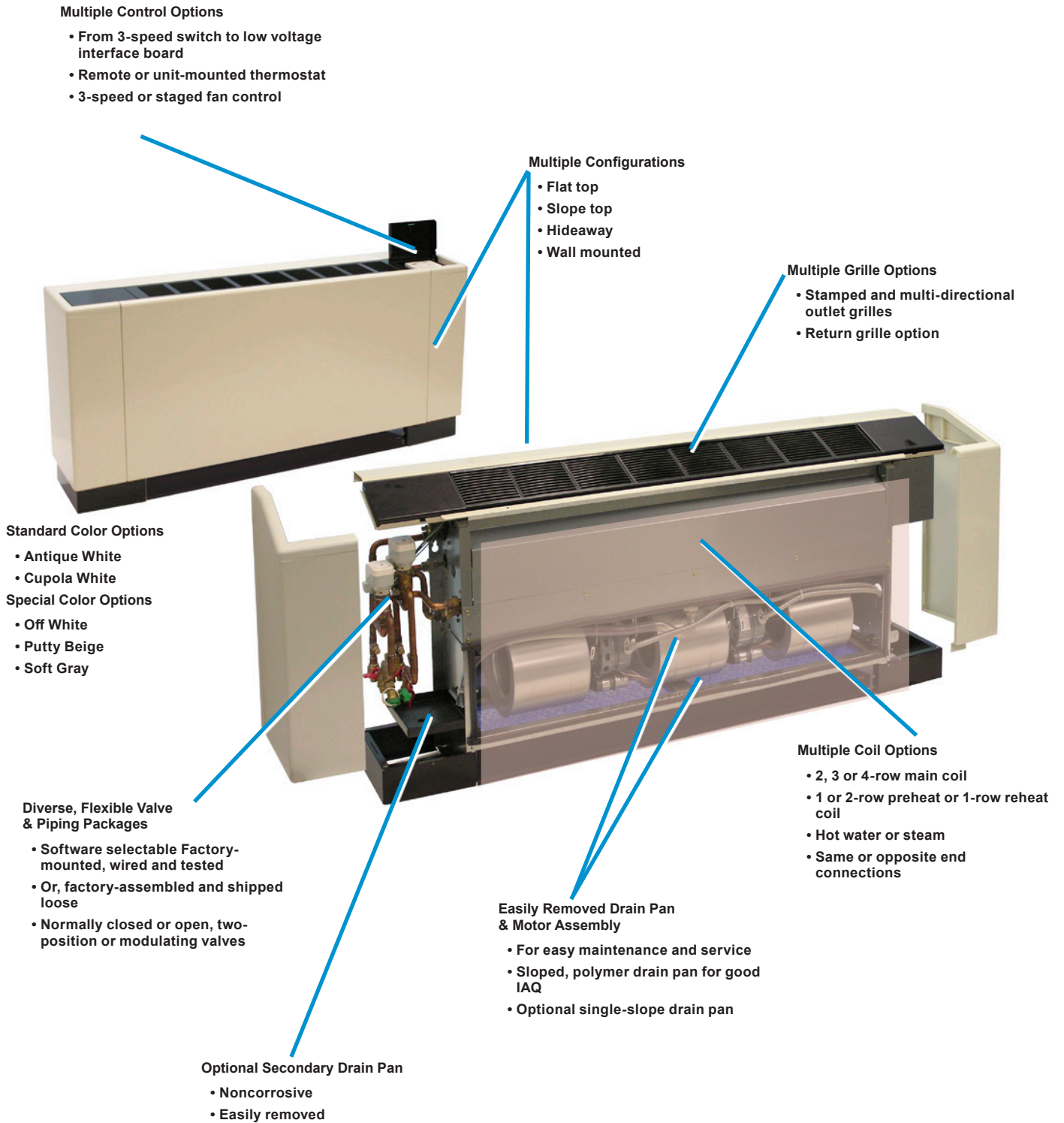
- Coil options include two, three, and four-row main coils to provide precise heating and cooling performance for any requirement. Separate, single-row reheat coils (hot water or steam) are available. Separate, one-row or two-row preheat coils are also available with same or opposite-end coil connections.
- Multiple control options range from a simple fan speed switch to a low voltage interface board that can tie into most building automation systems. Non-communicating or communicating control options for LONTALK® and BACnet® will be available soon. Contact your Daikin representative for details.
- Grille options include stamped inlet and outlet grilles and multidirectional grilles. Aluminum fresh air boxes are also available.
- Appearance options include cabinet units with a durable, powder paint finish and decorative wall plate panels for hideaway units in Cupola White or Antique Ivory. Other colors such as Off White, Putty Beige and Soft Gray are available as specials. Custom colors can be matched as a special item. Leveling feet are available, as are rear cabinet extensions in 4 and 8-inch depths. Tamper-proof units are a selectable option, with 16-gauge steel panels, a return grille and key-operated, locking access doors.

### For contractors

For contractors, ThinLine fan coils feature Quick Ship options for fast delivery and a number of features that make installation fast and simple.

- Factory-mounted, wired and tested valve and piping packages for quick hookup to the building piping to reduce installation time. Packages can also be shipped loose with the unit for quick and easy field installation. Valve and piping packages are designed for entering-water-temperature sampling. This eliminates the need for inefficient bleed lines to sense automatic changeover on two-pipe units.
- Factory-mounted and tested controls minimize field setup. Depending on the option requested, controls can be wired with a 24 VAC transformer to provide a single-source power connection to the unit. Several options are available for unit or wall mounted thermostats and sensors. All wall-mounted thermostat and zone sensors require only low-voltage control wiring from the device to the unit control box.
- Easy, end-panel removal for hookup of electrical and piping connections minimizes field-labor time and cost.
- End compartment panels can be removed for installation and service without removing the front panel covering the fan blower section. This means that airflow through the filter and coil is not jeopardized for taking temperature and performance readings.
- Both the main drain pan and optional secondary drain pan are easily accessed for cleaning.
- The fan deck and motor assembly is easily removed when required for service.

**Figure 2: Unit Features**



## Control Options

### Manual 4-Position Fan Switch



Several styles of the four-position fan switch (OFF, High, Med, Low) are available for unit-mount, remote- or wall-mount. The remote-mount option operates on low-voltage or line-voltage power and can be provided with a factory-

mounted, low-voltage interface board, which contains (3) 24-volt relays with line-voltage contactors and terminal connections. The transformer is factory-installed and wired. The unit-mounted option operates on line voltage.

#### Sequence of operation

- **OFF:** Fan is turned OFF.
- **High, Medium, Low:** Fan runs continuously at the selected speed.

### Analog Electronic Thermostat, Unit-Mounted

The unit-mounted analog electronic thermostat option combines the three-position fan switch with an analog thermostat for room temperature control. It is compatible with two pipe or four pipe fan coils and is available with automatic (MTB-155) or manual (MTA-155) changeover.



#### Sequence of operation

##### Fan Switch

- **OFF:** Fan is turned OFF. Thermostat is OFF. The ON/OFF motorized control valve, when supplied, is closed.
- **High, Medium, Low:** Fan runs continuously at the selected speed.

##### Thermostat

- Cycles the valve(s) open or closed on demand based on occupant-desired level.

##### Changeover:

- **Manual:** The user selects whether the thermostat operates in heating or cooling mode. In heating mode the valve opens when the room temperature is below the set point. In cooling the valve opens when the room temperature is above the set point. A factory installed aquastat prevents valve operation if heating is selected when pipes contain chilled water or if cooling is selected when pipes contain hot water.
- **Automatic:** The thermostat automatically selects heating or cooling mode based on the temperature of the water in the pipes. A factory installed aquastat operates the valve in heating mode when the pipes contain hot water or cooling mode when pipes contain chilled water.

### MT155 Thermostat, Wall-Mounted



The MT155 series thermostat provides ON-OFF control for low-voltage or line-voltage valves and fan motors. It is remote-mounted. Options include manual or automatic changeover, two or four pipe fan coil control, with or without three speed control continuous fan

operation. This thermostat can be field-mounted on any vertical ThinLine fan coil unit equipped with a low voltage interface board, refer to Daikin publication [IM 1089](#).

This thermostat is capable of continuous fan operation and ON-OFF, normally closed valve control. The thermostat cycles the valves ON and OFF with demand. The fan runs continuously at the manually selected fan speed. When the system switch is in the OFF position, the fan is OFF and the valve is closed.

### Digital Thermostats, Unit- and Wall-Mounted

Daikin offers a broad range of unit-mounted and remote, wall-mounted digital thermostats with the capability to control ON-OFF, 3-wire floating and proportional modulating actuator, and Normally-Closed or Normally-Open valves. See [Table 1](#). For more information, refer to the Daikin publication [ED 18513-1](#) and Installation Manuals for the specific thermostat (also see [IM 980-1](#)).



### MT158 and MT168 Thermostat-Controllers with Digital Display

Series MT158 and MT168 microprocessor-based thermostat controllers combine a proportional integral (PI) control algorithm with adaptive logic. They can be unit-mounted or remote-wall mounted.



Heating and cooling outputs for the MTB158 are individually configurable for three-wire floating point, ON/OFF normally open, or ON/OFF normally closed control valves.

Heating and cooling outputs for the MT168 provide 0-10 Vdc or 4-20 mA. An integrated, three-speed fan control switch is line-voltage capable to allow direct connection to the fan motors. A manual or automatic changeover is provided with remote setback capability from a time clock or facility management system. Features include a Fahrenheit or Celsius digital display and built-in purge cycling which assists the controller to determine if the system is supplying hot water or chilled water.

Standard control features constant fan operation with cycled or modulating valve operation. The fan runs continuously at the manually selected fan speed (High, Medium or Low). The controller modulates or cycles the valve with demand.

### T170 and T180 Wall Mounted Thermostats



Daikin offers four different wall mounted Digital Heating/ Cooling Thermostats with constant fan or Fan cycled, ON/OFF normally closed Valve Control. The non-programmable TA170 and TB170 and the seven day, four event programmable TA180 and TB180.

The TA170 and TA180 are configured for user selected fan speed control. The TB170 and TB180 are configured for staged fan speed control where the thermostat selects high, medium, or low based on the room temperature and set point differential. All four provide automatic and manual changeover, adjustable dead band, one two or three speed fan control, adjustable setback, condensate overflow alarm and on-off normally closed damper control. All can be used with line or low control voltage. The thermostat interface contains buttons for use in navigation to accompanying menus/screens and for performing specific operations. Detailed installation instructions and modes of operation can be found in [IM 1152](#).

**Table 1: Thermostat Summary Table**

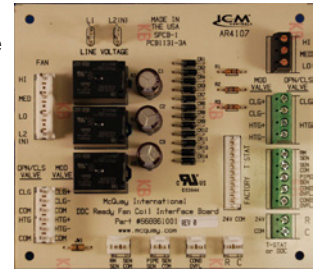
Thermostat Type	Model	Mounting	Software Tabs
On/Off Switch with 3-speed Fan Switch with Hi/Med/Lo Settings and Switched Auxiliary Connection	MTE-155	Unit or Remote*	Control Type or Accessories
2-Pole Dead-Band Auto-Changeover Thermostat with Manual ON-OFF System Switch and Manual 3-Speed Fan Switch, ON/OFF Valve Control	MTB-155	Unit or Remote*	Analog Control Type or Accessories
Thermostat with Manual Heat-OFF-Cool System Switch and Manual 3-speed Fan Switch, ON/OFF Valve Control	MTA-155	Unit or Remote*	Analog Control Type or Accessories
Digital Thermostat 24 vac/120-277 vac with 3-speed Fan Control (Continuous or Fan Cycle)	MTA-170	Remote	Accessories
Digital Thermostat with 7-Day Programmable, 24 vac/120-277 vac with 3-speed Fan Control (Continuous or Fan Cycle)	MTA-180	Remote	Accessories
Digital Thermostat 24 vac/120-277 vac with Staged Fan (Continuous or Fan Cycle)	MTB-170	Remote	Accessories
Digital Thermostat with 7-Day Programmable, 24 vac/120-277 vac with Staged Fan (Continuous or Fan Cycle)	MTB-180	Remote	Accessories
Digital Thermostat with Dead Band Auto-Changeover for Heating/Cooling, ON/OFF or 3-wire Floating Valve Control and 3-speed Fan Switch	MTB-158	Unit or Remote*	Digital Control Type or Accessories
Digital Thermostat with Dead Band Auto-Changeover for Heating/Cooling, ON/OFF, and Manual 3-speed Fan Switch	MTA-158	Unit or Remote*	Digital Control Type or Accessories
Digital Thermostat with Auto-Changeover, Dead-Band, 0-10 vDC Proportional Modulating Valve Control.	MTB-168	Unit or Remote*	Digital Control Type or Accessories
Digital Thermostat with Auto-Changeover, Dead-Band, 0-10 vDC Proportional Modulating Valve Control, and Manual 3-speed Fan Switch	MTA-168	Unit or Remote*	Digital Control Type or Accessories

\*Can be field-mounted on units with Low Voltage Interface Boards, refer to [IM 1089](#)

**NOTE:** (†)To select a thermostat with a manual switch (MTA-155), simply click on the "Manual" option in the Changeover selection box in Daikin Tools software. If no factory valves are provided, the default choice for this thermostat type will be an Autoswitch (MTB-155).

### Low Voltage Interface Board

The Low-Voltage, Interface Board (LV board) is used with any remote (wall-mounted) Daikin thermostat. It can also be used with a BAS (Building Automation System) control where low voltage is needed to operate a fan coil.



The LV interface board includes:

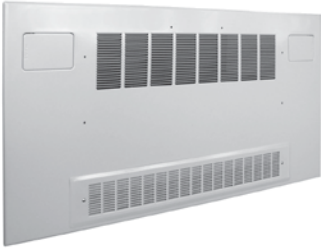
- Three 24-volt relays with line voltage contactors to operate fan motor speeds
- A factory wired and installed transformer
- Terminal connections for interfacing to:
- An optional wall-mounted thermostat
- Low-voltage actuators for heating and cooling valves
- A return air sensor
- A pipe temperature sensor for changeover from heating to cooling on two-pipe systems
- An optional condensate overflow switch

### Customer-Supplied Controls

Your Daikin representative can work with engineers and/or contractors to factory install and wire other manufacturers' DDC controllers in one of the end pockets of the fan coil. Contact your local Daikin representative for assistance with your specific project.

## Unit Accessories

### Decorative Wall Plate Option



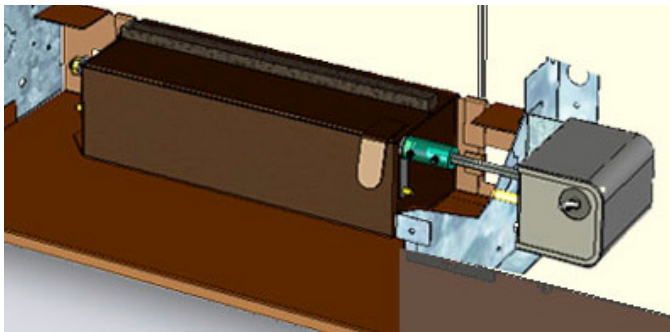
Decorative wall plates have rounded corners for an attractive appearance. Wall plate can be selected as an accessory in a variety of colors with front or top discharge. Custom colors may be available. Contact your Daikin Applications Group with inquiries. For Dimensions, see [Figure 16 on page 26](#).

### Cabinet Color Options

Exposed units are shipped in the standard color of Antique Ivory. Special colors include: Cupola White, Off White, Putty Beige and Soft Gray. For details of paint colors and finishes, refer to Daikin publication Form [2F-1188](#). Metal samples are available upon request.

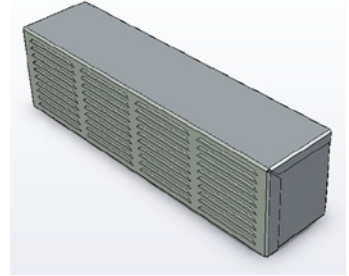
### Fresh Air Damper Options (Manual and Motorized)

A fresh air intake damper that will provide up to 25% fresh air can be ordered either as factory-installed or as a field-installed kit. The kit consists of an intake with damper blade and insect screen. The damper may be manually controlled through the return air opening or with an optional factory- or field-installed 24 V damper motor. If freezing air temperatures are expected, the damper must be closed or outside air must be tempered before entering the unit. A low-temperature sensor is recommended.



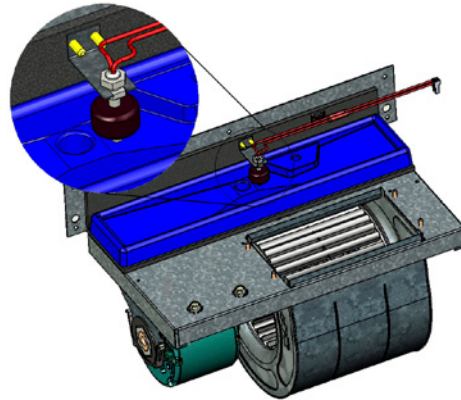
### Fresh Air Intake Box Option

Fabricated of aluminum with weep holes, the Fresh Air Intake Box has a double set of louvers in series to prevent moisture draw-through. This is used with a fresh air damper and is mounted in an exterior wall. For Dimensions, see [Figure 17 on page 26](#).



### Condensate Overflow Switch Option

With proper mounting, the condensate overflow switch will detect water collecting in the primary drain pan before an overflow can occur. This is a N.C. low voltage switch that opens when water levels rise and closes when water is no longer present. The switch should be field-wired to a controller to facilitate the fan and/or control valve shut-down when condensate starts collecting in the drain pan.



### Tamperproof Cabinet Option

This option can be factory- or field-installed on cabinet units to prevent access to unit controls and unauthorized removal of cabinet panels. It includes a key lock access door to unit controls and torx head screws for cabinet panels. Stamped grille for return air is standard with tamper-proof models.



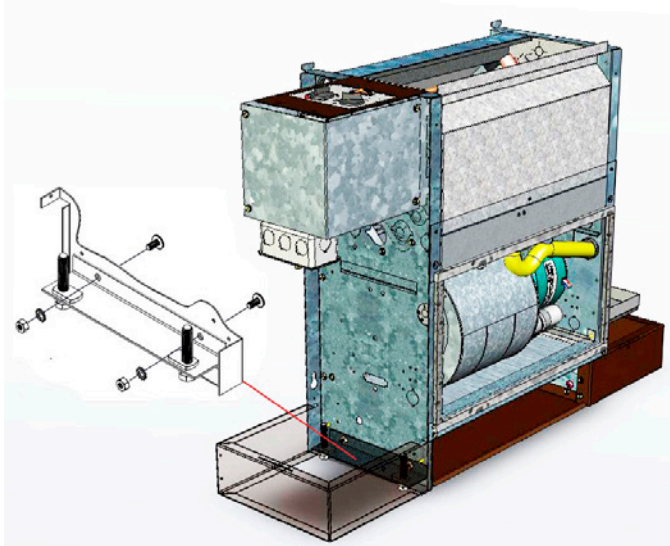
### Return Air Grille

A stamped-steel return air grilles are available as factory- or field-installed options. This option is standard with tamper-proof models.



### Leveling Legs Option

Field- or factory-installed kits are available with 0" to 1" adjustment for positive leveling of floor-mounted units.

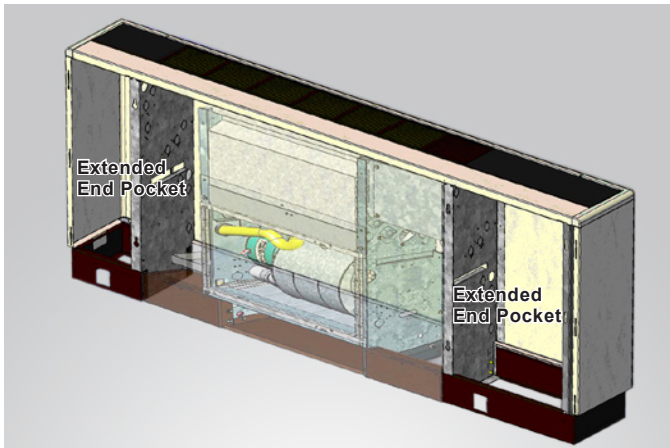


### Extended End Pockets and Raised Sub-bases

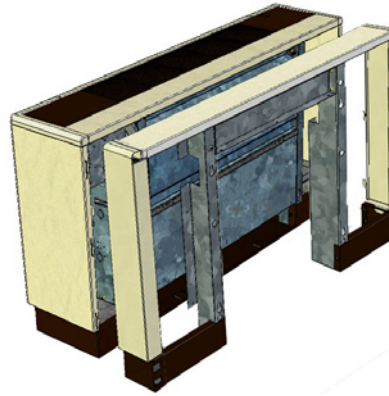
Standard end pockets on Daikin units can accommodate most installation requirements. Therefore, extended pockets are seldom needed. However, units with 4" or 8" extensions on one or both sides of the unit are available. As a rule, a total extension of 8" is only possible. The extended end pockets are used for applications with field-installed valve piping packages or controls by others when extra space is needed. They can also be used for remodeling or replacement projects to hide floor covering terminations.

**NOTE:** When extended end pockets are used, a standard rear cabinet extension may not be usable. Call your Daikin Sales Representative for suggestions.

Raised sub-base options are also available. Contact your Daikin Sales representative for details.



### Rear Cabinet Extension Option



This kit is available for applications where additional depth is needed. This kit is not designed to be an air duct or outside air plenum. 4" or 8" extension kits are standard. Other extension depths are available as a special request. Contact your Daikin representative for details.

Some common applications for the rear cabinet extension include:

- Additional depth for unit appearance
- Additional clearance for cross-over piping and connections
- Extend the discharge grille past drapery or wall hangings
- Hide floor covering terminations in remodeling projects
- Piping entry through the side panels of the unit

**NOTE:** When extended end pockets are used, a standard rear cabinet extension may not be usable. Call Daikin Applications Group for suggestions.

## Factory Valve & Piping Packages

Factory valve and piping packages are available for both two-pipe and four-pipe systems with either right or left hand connections. Four-pipe systems can be configured with the heating and cooling connections on the same or opposite sides of the unit. Packages can be either factory-installed or factory-assembled and shipped loose with the unit. Units are also available without valve and piping packages in either a right-hand or left-hand configurations. All packages are fully leak tested.

Factory-installed packages are sweated to the coil and wired to the unit control box or LV Interface Board. Chilled and hot water pipes are the only field connections required. Piping is 1/2" nominal copper (5/8" OD).

**Figure 3: Four-Pipe Deluxe Valve and Piping Package**



Pre-determined field connection points are located for easy access. See [Figure 11 on page 13](#) for connection locations. The installing contractor can pre-pipe the building water connections before the units arrive on the jobsite. A label clearly identifies chilled and hot water connection points on every unit.

All chilled water piping and components are located to allow condensate to drain into the secondary drain pan supplied with the valve package. Insulation of the factory piping package is not required.

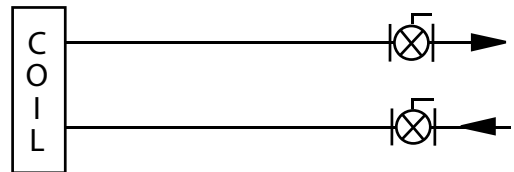
## Available Packages

Numerous piping packages are available to match design configurations. Additional components can be added to meet exact requirements, including P/T ports, unions, and flexible stainless steel hoses.

### Shut-Off Only Packages

Shut-Off Only piping packages provide interconnecting copper piping and shut-off ball valves for ease in connecting supply and return lines to the unit. Four-pipe packages include a venting valve for the preheat or reheat coil. Primary coils on all units have an integral venting valve.

**Figure 4: Shut-Off Only Package**

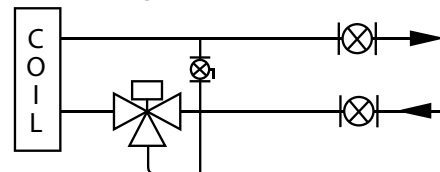


(See [Figure 10](#) for components key)

### Basic Packages

Basic valve and piping packages add control valves to the Shut-Off Only package. All Daikin control valves are factory-mounted in the supply water pipe. See [Control Valve Options on page 12](#) for more information on the variety of control valves available.

**Figure 5: Basic Package**

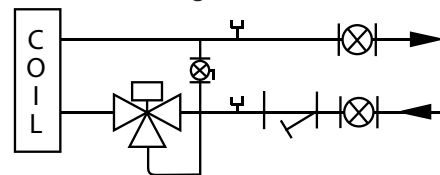


(See [Figure 10](#) for components key)

### Enhanced Packages

Enhanced valve and piping packages add a strainer to the Basic package supply water pipe. The strainer is attached to the supply water pipe at the coil connections. The strainer body is cast brass construction with a stainless steel mesh that is easy to remove for cleaning.

**Figure 6: Enhanced Package**



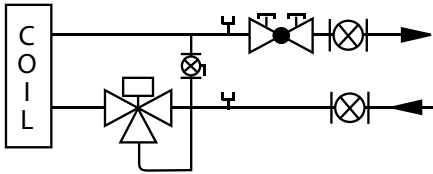
(See [Figure 10](#) for components key)

**Premium Packages**

Premium valve and piping packages replace the Basic package a ball valve in the return line with a manual or automatic circuit setter. The manual circuit setter is also known as a manual flow control valve. The auto circuit setter acts as both a flow setting device and a shut-off valve. It allows water flow through the fan coil to be set quickly and accurately. The circuit setter includes a cartridge within the valve body that is sized to allow a specific flow rate through the coil without any action required by a system piping balancer.

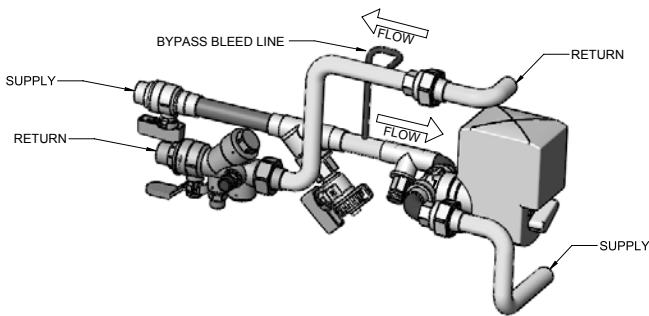
P/T ports are included, which are used to measure the temperature or pressure drop across the valve. This pressure drop can be compared to factory supplied tables that relate the pressure drop to a specific flow rate. The manual circuit setter valve also has a memory stop so that the correct setting can be found quickly.

**Figure 7: Premium Package**



(See Figure 10 for components key)

**Figure 8: Bypass Bleed Line**

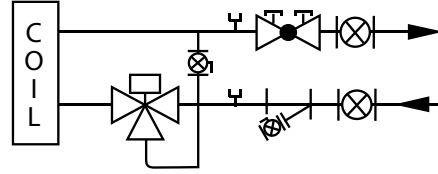


**NOTE:** A bypass bleed line is installed on all factory provided fan coil valve packages with a 2-way control valve to prevent stagnation of water near the changeover switch (aqua-stat) or changeover sensor (10K pipe sensor). The bleed line allows 3 – 4 gpm of flow to bypass the coil which is necessary for the proper function of the automatic changeover system. All valve packages, cooling and heating, with a 2-way control valve automatically include the bypass bleed line. If the bleed line is unwanted, it may be crimped by the installing contractor to prevent bypass flow.

**Deluxe Packages**

Deluxe valve and piping packages add a strainer to the Premium package. The strainer is available with or without an optional draining (blow-off) valve.

**Figure 9: Deluxe Package**



(See Figure 10 for components key)

**Figure 10: Components Key for Schematics**

		<b>Manual Shutoff Ball Valve:</b> Water shut-off. Handle rotates 90 degrees.
		<b>Manual Shutoff Ball Valve with Memory Stop:</b> Used on return line for limiting water flow.
		<b>2-Way, N.C., On/Off Valve, Spring Return:</b> Turn On or Off water flow to the coil in response to 24V or line voltage signal
		<b>3-Way, N.C., On/Off Valve, Spring Return:</b> Bypass water flow away from coil in response to 24V or line voltage signal. Includes fixed orifice for balancing.
		<b>2-Way Modulating Valve (3-wire or proportional):</b> Modulates water flow in response to 24V signal.
		<b>3-Way Modulating Valve (3-wire or proportional):</b> Modulates or bypass water flow in response to 24V signal. Includes fixed orifice for balancing.
		<b>PT Port:</b> For connecting a pressure or temperature gauge.
		<b>Y-Strainer:</b> Removable screen filters out small particles from supply line during normal system operation.
		<b>Manually Adjustable Circuit Setter with Shutoff:</b> Pressure-dependent, ball-type, manual flow control.
		<b>Cartridge-Type, Auto-Fixed Circuit Setter:</b> Pressure-compensated, automatic fixed-flow control.
		<b>Union:</b> For easy removal of piping from coil.
		<b>Bypass Balancing Valve:</b> Adjustable balancing of water flow through the bypass circuit on a 3-way control valve.

**Note:** Daikin 3-way valves are equipped with a fixed balance orifice in the bypass line, eliminating the need for a separate balancing valve

## Control Valve Options

Except for Shut-off Only packages, all valve and piping packages include control valves for controlling water flow. All Daikin control valves are factory assembled and mounted in the supply water pipe downstream of the coil. Several options are available:

### Two-Way/Two-Position Valves

These valves will be either Fully-Open or Fully-Closed in response to a line voltage (115, 208-230 or 265-277 VAC) or 24 VAC signal from the Daikin thermostat or controller. Some means of relieving pump head pressure should be applied when two-way valves are selected. Normally-Open or Normally-Closed valves are available, both spring-return type.

### Three-Way Two-Position Valves

These valves either allow full water flow through the coil or divert the flow through a bypass line. The valves respond to a line voltage (115, 203-230 or 265-277 VAC) or to 24 VAC signal from the Daikin thermostat or controller. All standard three-way valves come with a fixed-balance orifice in a bypass line to compensate for flow balancing in the bypass position, eliminating the need for an additional balancing valve. Normally-Open or Normally-Closed valves are available.

### Motor option

Horizontal ThinLine fan coil units are equipped with standard three-tap Permanently-Split Capacitor (PCS) motors for 115/1/60, 208-230/1/60 and 277/1/60 volt applications. Optional brush-less DC Electronically Commutated Motors (ECMs) are available for the above voltage ranges. These motors are also used for high-static applications. All motors are connected to a unit-mounted electric panel with Quick-Connect fitting for ease of maintenance

### Two-Way Modulating Valves

These valves modulate the water flow through the coil in response to a signal from the Daikin thermostat or controller. Standard Daikin modulating valves are three-wire floating point equal percentage valves. Zero to 10 VDC proportional valves are also available. The modulating valves are factory mounted in the supply water pipe upstream of the coil.

### Three-Way Modulating Valves

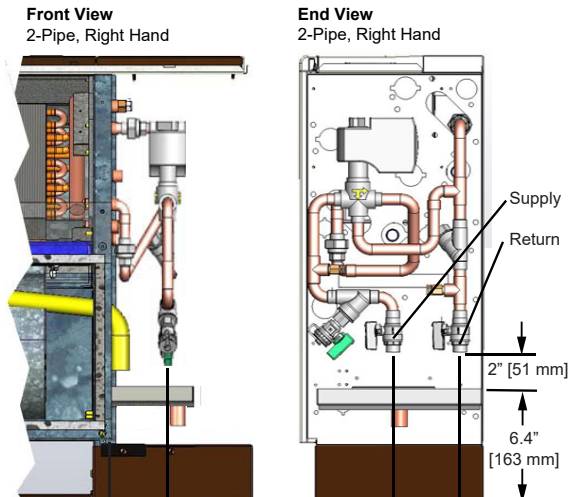
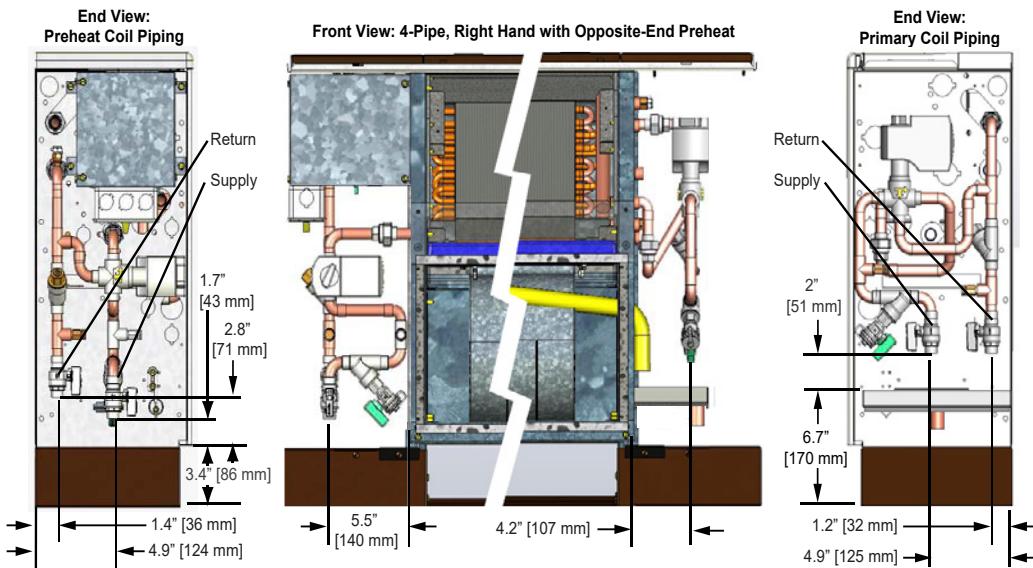
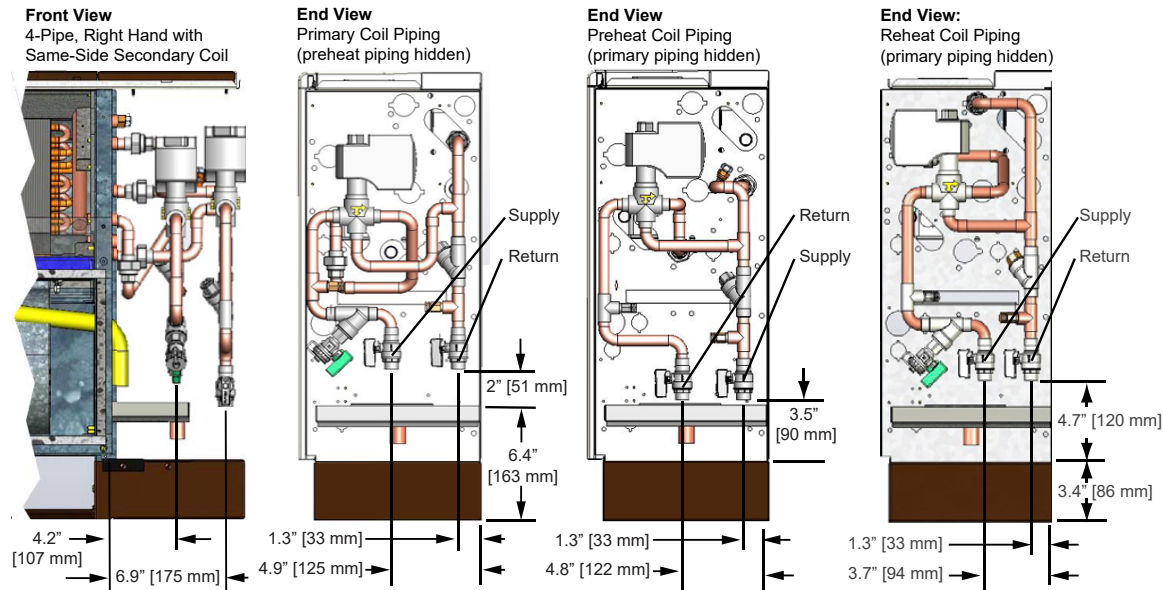
These valves modulate water flow through a coil in response to a signal from a Daikin thermostat or controller. Three-way valves allow water that is directed through the coil to mix with water that is directed through the bypass line. This mixture exits through the leaving water pipe. Modulating valves are three-wire, floating-point equal percentage valves or 0-10 VDC proportional. The modulating valves are factory mounted in the supply water pipe upstream of the coil.

### Selecting Correct Size Modulating Valves

Daikin Tools™ software automatically selects the best modulating valve size for the unit and coil being considered. By combining the [AHRI](#) performance data, the coil flow rate and the DP across the water coil, the water coil Cv is calculated and the best matching modulating port size is selected. Valve and piping packages can easily be configured and automatically selected using Daikin Tools™.

Figure 11: Hook Up Locations: Factory-Installed Valve and Piping Packages

4-pipe arrangement wit Same end Connections



**Deluxe valve packages are shown.**

**NOTE:** All valve packages, regardless of components included, have the same hookup locations. Right-hand connections are shown here. Left-hand connection distances are the same. Distances to connections from chassis are from unit mounting holes. Dimensions may vary slightly from given values.

To achieve an efficient fan coil system, accurate system design and proper equipment selection is necessary. Variations, limitations/control of fan coil systems, design conditions and design load calculations are not described in detail in this catalog. More detailed information may be found in the [ASHRAE](#) Guide. This catalog contains AHRI-certified ratings and application ratings for ThinLine fan coil units from which a design engineer can make initial unit selections to meet system requirements.

A mechanical system designer must select the unit types best suited to the overall system before the actual unit sizes can be determined. The factors that generally influence this decision are: intended building usage, building layout, architectural and aesthetic values, economics, geographical location, and type of maintenance service available. The general results may be a mixture of unit types within a given system. Daikin manufactures fan coil units to meet many needs including ThinLine, HiLine™ and Large Capacity models. For Daikin product information, please go to [www.DaikinApplied.com](http://www.DaikinApplied.com).

## Basic design data

Prior to selecting individual unit sizes, a design engineer must fix or determine the following factors:

- Inside and outside wet and dry bulb design temperatures
- Total and sensible heat gains and losses of the area to be served
- Ventilation air
- Properties of the heating and cooling medium
- Available electric power service
- Any special design requirements of the building or system

## Unit Size

The capacity ratings presented in this catalog are provided for initial unit selection only. Water cooling and heating capacities, unit air flow, static pressure and glycol solutions are all incorporated into the program to provide the best possible selection. Consult your Daikin representative for a selection tailored to specific applications.

Unit sizes for the ideal system should be selected by calculating peak load requirements due to unusually high occupancy or severe climatic conditions and with fans operating at high speed. Ordinary day-to-day cooling and heating requirements are then achieved at low and medium speeds.

The initial unit selection should be checked for air volume in the design system and the cooling capacities checked against actual operating conditions. While units selected on the basis of sensible load will generally meet the total cooling load, total load should be checked in all cases.

The unit size is generally selected on the basis of matching the sensible cooling capacity of the unit with the calculated requirements when operating at high speed.

## Coil Types

Standard coils are designed to meet both cooling and heating requirements in a typical system. Two additional levels of enhanced primary coils are available to meet the total and sensible requirements of any application.

Heating requirements for two-pipe systems are generally met by employing the same water flow rate as cooling and adjusting the entering hot water temperature to obtain a matching unit heat output at low fan speed.

Four-pipe systems are generally designed by specifying the flow rate through the separate heating coil to meet the required heat load with the fan operating at the desired fan speed. Daikin offers two coil options for preheat and one option for reheat.

## Two-Pipe Systems - Hot Water Heat

All performance measured on high speed tap, 115 V, zero ESP, with a throwaway filter. Cooling performance is based on 80/67°F (27/19°C) entering air temperature, 45°F (7°C) entering chilled water temperature with a 10°F (5.5°C) ΔT.

Heating performance is based on 70°F (21°C) entering air temperature, 180°F (82°C) entering hot water temperature with a 30°F (17°C) DT.

**Table 2: Cooling and Heating Performance – Two-Pipe Systems**

Unit Size	Main Coil Rows	SCFM	Cooling Performance*				Heating Performance*			
			Total MBh (kW)	Sensible MBh (kW)	G(L/s)	WPD Ft H <sub>2</sub> O (kPa)	MBh	Q/ITD	G(L/s)	WPD Ft H <sub>2</sub> O (kPa)
02	2 Row	218	4.2 (1.2)	3.8 (1.1)	0.9 (0.06)	0.3 (0.9)	14.1 (4.1)	0.128 (0.067)	0.9 (0.06)	0.3 (0.9)
	3 Row	209	5.7 (1.7)	4.6 (1.3)	1.2 (0.08)	0.5 (1.5)	17.2 (5.0)	0.156 (0.082)	1.2 (0.08)	0.5 (1.5)
	4 Row	200	5.9 (1.7)	4.7 (1.4)	1.2 (0.08)	0.6 (1.8)	19.2 (5.6)	0.175 (0.092)	1.2 (0.08)	0.6 (1.8)
03	2 Row	299	5.0 (1.5)	4.8 (1.4)	1.1 (0.07)	0.4 (1.2)	19.8 (5.8)	0.180 (0.095)	1.1 (0.07)	0.4 (1.2)
	3 Row	291	6.9 (2.0)	6.0 (1.8)	1.5 (0.09)	0.5 (1.5)	24.4 (7.2)	0.222 (0.118)	1.5 (0.09)	0.5 (1.5)
	4 Row	265	9.4 (2.8)	6.9 (2.0)	1.9 (0.12)	1.5 (4.5)	27.2 (8.0)	0.247 (0.131)	1.9 (0.12)	1.5 (4.5)
04	2 Row	398	8.0 (2.3)	7.2 (2.1)	1.7 (0.11)	1.0 (3.0)	28.3 (8.3)	0.257 (0.136)	1.7 (0.11)	1.0 (3.0)
	3 Row	385	10.7 (3.1)	8.7 (2.5)	2.2 (0.14)	1.3 (3.9)	34.0 (10.0)	0.309 (0.164)	2.2 (0.14)	1.3 (3.9)
	4 Row	374	14.3 (4.2)	10.2 (3.0)	2.9 (0.18)	3.4 (10.2)	38.9 (11.4)	0.354 (0.187)	2.9 (0.18)	3.4 (10.2)
06	2 Row	602	14.0 (4.1)	11.5 (3.4)	2.9 (0.18)	4.4 (13.1)	41.0 (12.0)	0.373 (0.196)	2.9 (0.18)	4.4 (13.1)
	3 Row	565	17.7 (5.2)	13.3 (3.9)	3.7 (0.23)	5.2 (15.5)	47.1 (13.8)	0.428 (0.226)	3.7 (0.23)	5.2 (15.5)
	4 Row	554	22.4 (6.6)	15.2 (4.5)	4.6 (0.29)	9.0 (26.9)	52.6 (15.4)	0.478 (0.252)	4.6 (0.29)	9.0 (26.9)
08	2 Row	675	17.0 (5.0)	13.4 (3.9)	3.6 (0.23)	7.7 (23.0)	50.3 (14.7)	0.457 (0.241)	3.6 (0.23)	7.7 (23.0)
	3 Row	656	21.7 (6.4)	15.9 (4.7)	4.5 (0.28)	8.0 (23.9)	58.7 (17.2)	0.534 (0.281)	4.5 (0.28)	8.0 (23.9)
	4 Row	634	26.4 (7.7)	17.8 (5.2)	5.5 (0.35)	14.8 (44.2)	64.3 (18.8)	0.585 (0.308)	5.5 (0.35)	14.8 (44.2)
10	2 Row	831	20.9 (6.1)	16.7 (4.9)	4.4 (0.28)	6.8 (20.3)	62.4 (18.3)	0.567 (0.299)	4.4 (0.28)	6.8 (20.3)
	3 Row	808	27.4 (8.0)	19.9 (5.8)	5.7 (0.36)	8.7 (26.0)	73.2 (21.5)	0.665 (0.352)	5.7 (0.36)	8.7 (26.0)
	4 Row	795	32.4 (9.5)	21.9 (6.4)	6.7 (0.42)	11.1 (33.2)	80.8 (23.7)	0.735 (0.388)	6.7 (0.42)	11.1 (33.2)
12	2 Row	1118	27.1 (7.9)	21.2 (6.2)	5.6 (0.35)	12.5 (37.4)	78.3 (22.9)	0.712 (0.375)	5.6 (0.35)	12.5 (37.4)
	3 Row	1059	34.5 (10.1)	24.9 (7.3)	7.1 (0.45)	15.5 (46.3)	95.4 (28.0)	0.867 (0.458)	7.1 (0.45)	15.5 (46.3)
	4 Row	1022	40.2 (11.8)	27.0 (7.9)	8.3 (0.52)	18.3 (54.7)	103.8 (30.4)	0.944 (0.497)	8.3 (0.52)	18.3 (54.7)

\* Performance at medium or low fan speed settings is approximately 88% and 68%, respectively, of that shown in the table above. 115/1/60 PSC motor at high speed setting.

## Four-Pipe Systems - Hot Water Preheat (1 or 2 row) or Reheat (1 row)

All performance measured on high speed tap, 115 V, zero ESP, with a throwaway filter. Cooling performance is based on 80/67°F (27/19°C) entering air temperature, 45°F (7°C) entering chilled water temperature with a 10°F (5.5°C) ΔT.

Heating performance is based on 70°F (21°C) entering air temperature, 180°F (82°C) entering hot water temperature with a 30°F (17°C) DT.

**Table 3: Cooling and Heating Performance – Four-Pipe Systems, Hot Water Heat**

Unit Size	Main Coil Rows	Heating Coil Rows	SCFM	Cooling Performance				Heating Performance			
				Total MBh (kW)	Sensible MBh (kW)	G(L/s)	WPD Ft H <sub>2</sub> O (kPa)	MBh (kW)	Q/ITD	G(L/s)	WPD Ft H <sub>2</sub> O (kPa)
02	2 Row	1 Row	201	4.0 (1.2)	3.6 (1.1)	0.8 (0.05)	0.3 (0.9)	8.4 (2.5)	0.076 (0.041)	0.9 (0.1)	1.4 (4)
		2 Row*	192	3.9 (1.1)	3.5 (1.0)	0.8 (0.05)	0.3 (0.9)	11.6 (3.4)	0.105 (0.056)	0.8 (0.1)	0.6 (1.8)
	3 Row	1 Row	192	5.3 (1.6)	4.3 (1.3)	1.1 (0.07)	0.4 (1.2)	8.2 (2.4)	0.075 (0.039)	0.9 (0.1)	1.3 (4)
		2 Row*	184	5.1 (1.5)	4.2 (1.2)	1.1 (0.07)	0.4 (1.2)	11.3 (3.3)	0.102 (0.054)	0.8 (0.1)	0.6 (1.8)
	4 Row	1 Row	184	5.7 (1.7)	4.5 (1.3)	1.2 (0.08)	0.6 (1.8)	8.1 (2.4)	0.073 (0.039)	0.9 (0.1)	1.3 (4)
		2 Row*	176	6.4 (1.9)	4.7 (1.4)	1.3 (0.08)	0.7 (2.1)	11.0 (3.2)	0.100 (0.052)	0.8 (0.1)	0.5 (1.5)
03	2Row	1 Row	275	4.7 (1.4)	4.5 (1.3)	1.0 (0.06)	0.4 (1.2)	12.4 (3.6)	0.113 (0.059)	1.3 (0.1)	3.5 (10)
		2 Row*	263	4.6 (1.3)	4.4 (1.3)	1.0 (0.06)	0.4 (1.2)	17.3 (5.1)	0.157 (0.083)	1.2 (0.1)	1.5 (4.5)
	3 Row	1 Row	268	6.5 (1.9)	5.6 (1.6)	1.4 (0.09)	0.4 (1.2)	12.3 (3.6)	0.112 (0.059)	1.3 (0.1)	3.4 (10)
		2 Row*	256	6.3 (1.8)	5.4 (1.6)	1.3 (0.08)	0.4 (1.2)	17.0 (5.0)	0.154 (0.082)	1.2 (0.1)	1.4 (4.2)
	4 Row	1 Row	244	8.8 (2.6)	6.4 (1.9)	1.8 (0.11)	1.3 (3.9)	11.7 (3.4)	0.107 (0.056)	1.2 (0.1)	3.2 (10)
		2 Row*	233	8.4 (2.5)	6.1 (1.8)	1.8 (0.11)	1.2 (3.6)	16.0 (4.7)	0.145 (0.077)	1.1 (0.1)	1.3 (3.9)
04	2 Row	1 Row	366	7.5 (2.2)	6.8 (2.0)	1.6 (0.10)	0.9 (2.7)	16.9 (5.0)	0.153 (0.082)	1.8 (0.1)	7.1 (21)
		2 Row*	350	7.3 (2.1)	6.5 (1.9)	1.5 (0.09)	0.8 (2.4)	23.7 (6.9)	0.215 (0.113)	1.7 (0.1)	2.9 (8.7)
	3 Row	1 Row	354	10.1 (3.0)	8.1 (2.4)	2.1 (0.13)	1.2 (3.6)	16.6 (4.9)	0.151 (0.080)	1.8 (0.1)	6.9 (21)
		2 Row*	339	9.7 (2.8)	7.8 (2.3)	2.0 (0.13)	1.1 (3.3)	23.2 (6.8)	0.211 (0.111)	1.7 (0.1)	2.8 (8.4)
	4 Row	1 Row	344	13.4 (3.9)	9.4 (2.8)	2.8 (0.18)	3.0 (9.0)	16.4 (4.8)	0.149 (0.079)	1.7 (0.1)	6.7 (20)
		2 Row*	329	12.9 (3.8)	9.1 (2.7)	2.7 (0.17)	2.8 (8.4)	22.7 (6.7)	0.207 (0.110)	1.6 (0.1)	2.7 (8.1)
06	2 Row	1 Row	554	13.3 (3.9)	10.8 (3.2)	2.8 (0.18)	4.0 (12.0)	23.2 (6.8)	0.211 (0.111)	2.8 (0.2)	19.6 (59)
		2 Row*	530	12.9 (3.8)	10.4 (3.0)	2.7 (0.17)	3.8 (11.4)	32.9 (9.6)	0.299 (0.157)	2.6 (0.2)	7.7 (23.0)
	3 Row	1 Row	520	16.7 (4.9)	12.4 (3.6)	3.4 (0.21)	4.6 (13.7)	22.5 (6.6)	0.205 (0.108)	2.7 (0.2)	18.5 (55)
		2 Row*	497	16.1 (4.7)	12.0 (3.5)	3.3 (0.21)	4.3 (12.9)	31.6 (9.3)	0.287 (0.152)	2.5 (0.2)	7.2 (21.5)
	4 Row	1 Row	510	21.0 (6.2)	14.2 (4.2)	4.3 (0.27)	8.0 (23.9)	22.3 (6.5)	0.203 (0.106)	2.6 (0.2)	18.2 (54)
		2 Row*	488	20.2 (5.9)	13.6 (4.0)	4.2 (0.26)	7.5 (22.4)	31.2 (9.1)	0.284 (0.149)	2.5 (0.2)	7.0 (20.9)
08	2 Row	1 Row	621	16.1 (4.7)	12.6 (3.7)	3.4 (0.21)	7.0 (20.9)	28.3 (8.3)	0.257 (0.136)	3.2 (0.2)	28.0 (84)
		2 Row*	594	15.6 (4.6)	12.2 (3.6)	3.3 (0.21)	6.6 (19.7)	40.0 (11.7)	0.364 (0.191)	3.0 (0.2)	10.7 (32.0)
	3 Row	1 Row	604	20.4 (6.0)	14.9 (4.4)	4.2 (0.26)	7.2 (21.5)	27.9 (8.2)	0.254 (0.134)	3.1 (0.2)	27.3 (82)
		2 Row*	577	19.7 (5.8)	14.3 (4.2)	4.1 (0.26)	6.8 (20.3)	39.2 (11.5)	0.357 (0.188)	2.9 (0.2)	10.4 (31.1)
	4 Row	1 Row	583	24.8 (7.3)	16.6 (4.9)	5.1 (0.32)	13.2 (39.4)	27.4 (8.0)	0.249 (0.131)	3.1 (0.2)	26.4 (79)
		2 Row*	558	23.9 (7.0)	16.0 (4.7)	5.0 (0.32)	12.4 (37.1)	38.4 (11.3)	0.349 (0.185)	2.9 (0.2)	9.9 (29.6)
10	2Row	1 Row	765	19.8 (5.8)	15.7 (4.6)	4.1 (0.26)	6.2 (18.5)	35.9 (10.5)	0.326 (0.172)	4.0 (0.3)	51.1 (153)
		2 Row*	731	19.2 (5.6)	15.2 (4.5)	4.0 (0.25)	5.8 (17.3)	50.6 (14.8)	0.460 (0.242)	3.8 (0.2)	18.8 (56.2)
	3 Row	1 Row	743	25.7 (7.5)	18.6 (5.5)	5.3 (0.33)	7.8 (23.3)	35.3 (10.3)	0.321 (0.169)	4.0 (0.3)	49.7 (149)
		2 Row*	711	24.9 (7.3)	18.0 (5.3)	5.1 (0.32)	7.3 (21.8)	49.6 (14.5)	0.451 (0.237)	3.7 (0.2)	18.2 (54.4)
	4 Row	1 Row	731	30.2 (8.9)	20.4 (6.0)	6.2 (0.39)	9.8 (29.3)	35.1 (10.3)	0.319 (0.169)	3.9 (0.2)	49.0 (146)
		2 Row*	700	29.1 (8.5)	19.6 (5.7)	6.0 (0.38)	9.2 (27.5)	49.1 (14.4)	0.447 (0.236)	3.7 (0.2)	17.8 (53.2)
12	2 Row	1 Row	1029	25.9 (7.6)	20.1 (5.9)	5.4 (0.34)	11.5 (34.4)	43.8 (12.8)	0.398 (0.209)	5.2 (0.3)	93.6 (280)
		2 Row*	984	25.2 (7.4)	19.4 (5.7)	5.2 (0.33)	11.0 (32.9)	62.7 (18.4)	0.570 (0.301)	5.0 (0.3)	34.6 (103.4)
	3 Row	1 Row	974	32.7 (9.6)	23.3 (6.8)	6.7 (0.42)	14.0 (41.8)	45.1 (13.2)	0.410 (0.216)	5.1 (0.3)	89.0 (266)
		2 Row*	932	31.7 (9.3)	22.6 (6.6)	6.6 (0.42)	13.3 (39.7)	64.1 (18.8)	0.583 (0.308)	4.8 (0.3)	32.4 (96.8)
	4 Row	1 Row	940	37.8 (11.1)	25.2 (7.4)	7.8 (0.49)	16.2 (48.4)	44.3 (13.0)	0.403 (0.213)	5.0 (0.3)	86.2 (258)
		2 Row*	899	36.5 (10.7)	24.3 (7.1)	7.6 (0.48)	15.2 (45.4)	62.6 (18.3)	0.569 (0.299)	4.7 (0.3)	31.0 (92.6)

NOTE: \*2-Row hot water coils are only available in the preheat position



## Four-Pipe Systems - Steam Preheat or Reheat

All performance measured on high speed tap, 115 V, zero ESP, with a throwaway filter. Medium and low-speed capacities are approximately 88% and 68% respectively of the high-speed capacity.

$$Q/ITD = \frac{\text{MBh (kW)}}{\text{Saturated steam temp} - \text{Entering air temp}}$$

To determine heating capacities at different entering steam pressure or entering air temperature, compute the new Inlet Temperature Differential (ITD) and multiply it by the Q/ITD shown. See [Table 5](#) to determine the saturated steam temperatures at various entering steam pressures. For more accurate values, use Daikin Tools™ selection program available from your Daikin representative.

**Table 4: Steam Coil Performance with Free-Discharge Motor**

Unit Size	Steam Coil Rows	2 psig (14 kPa) Total MBH (KW)	5 psig (103 kPa) Total MBH (KW)	Q/ITD MBH/°F (KW/°C)
02	Pre/ReHeat 1 Row	10.2 (3.0)	11.3 (3.3)	0.069 (0.036)
03	Pre/ReHeat 1 Row	14.4 (4.2)	16.0 (4.7)	0.098 (0.052)
04	Pre/ReHeat 1 Row	19.1 (5.6)	21.1 (6.2)	0.130 (0.069)
06	Pre/ReHeat 1 Row	28.7 (8.4)	31.7 (9.3)	0.195 (0.103)
08	Pre/ReHeat 1 Row	32.7 (9.6)	36.2 (10.6)	0.222 (0.117)
10	Pre/ReHeat 1 Row	40.9 (12.0)	45.4 (13.3)	0.279 (0.147)
12	Pre/ReHeat 1 Row	52.7 (15.4)	58.1 (17.0)	0.358 (0.189)

**NOTE:** \*2-Row coils only available in preheat position.

**Table 5: Steam Properties**

Steam Pressure PSIG (kPa)	2 (13)	3 (20)	4 (27)	5 (34)
Sat. Steam Temp. °F (°C)	219 (104)	222 (106)	224 (107)	227 (108)
Latent Heat Btu/Lb (kJ/kg)	966 (2245)	964 (2242)	962 (2239)	961 (2233)

## Air Volume Capacity Data

Air volumes shown in the table are measured at the motor speeds indicated with 115v/60/1 electrical power, with a 1" throwaway filter installed, and with a stamped discharge grille on a vertical cabinet unit or a discharge duct collar on a hideaway unit at approximately 0.10 inch of pressure drop.

**Table 6: Air Volume at Various Fan Speeds, scfm, PSC Motors**

Unit Size	Main Coil Rows	Heating Coil Rows	SCFM			Unit Size	Main Coil Rows	Heating Coil Rows	SCFM		
			Motor on High Speed	Motor on Medium Speed	Motor on Low Speed				Motor on High Speed	Motor on Medium Speed	Motor on Low Speed
02	2 Row	None	214	197	167	08	2 Row	None	668	585	465
		1 Row	197	181	154			1 Row	614	538	428
		2 Row*	188	173	147			2 Row*	588	515	409
	3 Row	None	204	190	161		3 Row	None	654	576	456
		1 Row	188	175	148			1 Row	601	530	419
		2 Row*	180	168	142			2 Row*	575	507	401
	4 Row	None	197	183	159		4 Row	None	632	562	450
		1 Row	181	169	146			1 Row	581	517	414
		2 Row*	173	161	140			2 Row*	556	495	396
03	2 Row	None	296	264	211	10	2 Row	None	831	712	548
		1 Row	272	243	194			1 Row	764	655	504
		2 Row*	260	232	186			2 Row*	731	626	482
	3 Row	None	292	256	205		3 Row	None	807	696	536
		1 Row	268	236	188			1 Row	742	640	493
		2 Row*	257	225	180			2 Row*	710	612	472
	4 Row	None	283	253	206		4 Row	None	789	680	523
		1 Row	260	233	189			1 Row	726	625	481
		2 Row*	249	223	181			2 Row*	695	598	460
04	2 Row	None	380	330	261	12	2 Row	None	1110	995	840
		1 Row	349	304	241			1 Row	1021	916	773
		2 Row*	334	291	230			2 Row*	977	876	740
	3 Row	None	365	325	250		3 Row	None	1059	960	822
		1 Row	336	299	230			1 Row	974	883	756
		2 Row*	321	286	220			2 Row*	932	845	723
	4 Row	None	368	319	249		4 Row	None	1025	930	803
		1 Row	338	294	229			1 Row	943	856	739
		2 Row*	323	281	219			2 Row*	902	818	707
06	2 Row	None	600	524	421						
		1 Row	552	482	387						
		2 Row*	528	461	371						
	3 Row	None	559	483	373						
		1 Row	514	445	343						
		2 Row*	492	425	329						
	4 Row	None	554	486	409						
		1 Row	510	447	376						
		2 Row*	488	427	360						

NOTE: \*2-row HW coils are only available in the preheat position

**Table 7: Approximate Air Volume for Units with ECM Motors for 3-Row Coils and External Static Pressure up to 0.2"**

Size	Vertical		
	High	Medium	Low
02	214	195	172
03	309	262	209
04	395	308	240
06	621	502	417
08	834	554	462
10	1011	692	539
12	1244	1003	836

MCA (Minimum Circuit Ampacity), MOP (Maximum Overcurrent Protection) or MFS (Maximum Fuse Size) Calculations

The minimum circuit ampacity (MCA) is the minimum wire size required for a field-wired product. The maximum overcurrent protection (MOP), or maximum fuse size (MFS) is the maximum fuse or circuit breaker size required to properly protect the equipment.

Select a standard fuse size or HACR type circuit breaker equal to the MOP. Standard Fuse Sizes are: 15, 20, 25, 30, 35, 40, 45, 50, 60 amps. Use the next larger standard size if the MOP does not equal a standard size. See Table 8 through Table 10 for motor FLAs.

HACR (Heating, Air-Conditioning and Refrigeration) type circuit breakers are required in the branch circuit wiring for all fan coils with electric heat.

**NOTE:** MCA and MOP ratings are based on the unit and electric heat power supply having the same voltage. If the electric heat power supply is different, a separate circuit breaker may be required. Follow local codes.

$$\text{Heater Amps} = \frac{(\text{Heater kW} \times 1000)}{\text{Heater Voltage}}$$

**NOTE:** Use 120V heater voltage for 115V units. Use 240V heater voltage for 230V units.

$$\text{MCA} = 1.25 \times (\text{heater amps} + \text{all motor FLAs})$$

$$\text{MOP or MFS} = (2.25 \times \text{Largest Motor FLA}) + \text{Second Motor FLA} + \text{Heater Amps [If Applicable]}$$

## Electric Heaters

Table 8: Electric Heat kW\*

Unit Size	Unit Voltage	kW									
02	115	0.5	1.0	1.5							
	230	0.5	1.0	1.5							
	277	0.5	1.0	1.5							
	208	0.4	0.8	1.2							
03	115		1.0	1.5	2.0						
	230		1.0	1.5	2.0						
	277		1.0	1.5	2.0						
	208		0.8	1.2	1.6						
04	115		1.0	1.5	2.0	2.5					
	230		1.0	1.5	2.0	2.5	3.0				
	277		1.0	1.5	2.0	2.5	3.0				
	208			1.2	1.6	2.0	2.5				
06	115			1.5	2.0	2.5					
	230			1.5	2.0	2.5	3.0	4.0			
	277			1.5	2.0	2.5	3.0	4.0			
	208				1.6	2.0	2.5	3.3			
08	115				2.0	2.5	3.0				
	230				2.0	2.5	3.0	4.0	5.0		
	277				2.0	2.5	3.0	4.0	5.0		
	208							2.5	3.3	4.1	
10	115					2.5	3.0				
	230					2.5	3.0	4.0	5.0	6.0	
	277					2.5	3.0	4.0	5.0	6.0	
	208							2.5	3.3	4.1	4.9
12	115						3.0				8.0
	230						3.0	4.0	5.0	6.0	8.0
	277						3.0	4.0	5.0	6.0	8.0
	208							3.3	4.1	4.9	6.5

**NOTE:** \*Electric heat MBh = (Heater kW) x(3.413)

## Motor Electrical Data

**Table 9: Electrical Data - Standard (Free Discharge) Motor – 2-Row Coil**

	Motor Speed	Size 02			Size 03			Size 04			Size 06			Size 08			Size 10			Size 12		
		Amps	Watts	RPM	Amps	Watts	RPM	Amps	Watts	RPM	Amps	Watts	RPM	Amps	Watts	RPM	Amps	Watts	RPM	Amps	Watts	RPM
115 V	High	0.49	53	1059	0.56	63	993	0.68	72	991	1.32	123	1122	1.20	129	1015	1.37	148	987	2.52	237	1123
	Med	0.42	44	984	0.48	53	886	0.57	59	876	0.99	95	987	1.01	108	910	1.16	124	866	1.81	175	1013
	Low	0.35	36	856	0.39	42	726	0.45	45	705	0.90	81	815	0.83	84	741	0.92	95	681	1.64	153	864
208 V	High	0.27	53	955	0.30	62	837	0.38	75	928	0.61	122	1102	0.77	154	1070	0.72	147	860	1.15	236	1113
	Med	0.23	48	766	0.24	52	639	0.30	59	764	0.44	87	910	0.58	48	709	0.58	120	681	0.83	166	960
	Low	0.19	39	561	0.19	42	485	0.25	49	611	0.36	65	691	0.50	39	504	0.45	93	533	0.70	127	708
230 V	High	0.27	57	1026	0.30	67	949	0.37	75	998	0.63	133	1124	0.80	180	1093	0.73	163	954	1.19	261	1131
	Med	0.23	52	914	0.25	60	791	0.31	64	880	0.41	89	1011	0.57	131	1006	0.61	139	797	0.81	178	1021
	Low	0.20	45	742	0.21	50	607	0.26	6	737	0.36	78	844	0.50	111	870	0.50	113	616	0.71	149	831
265 V	High	0.28	55	1026	0.29	61	931	0.34	77	917	0.47	117	1118	0.79	172	1097	0.65	149	906	0.95	246	1104
	Med	0.20	49	915	0.21	44	778	0.27	64	771	0.34	85	986	0.56	133	1007	0.50	126	737	0.74	188	933
	Low	0.16	41	758	0.16	43	597	0.20	46	609	0.30	69	836	0.47	114	882	0.38	99	594	0.63	152	737
277 V	High	0.29	57	1049	0.29	66	948	0.35	75	955	0.49	132	1125	0.81	183	1110	0.71	159	948	0.97	265	1115
	Med	0.22	51	953	0.22	58	788	0.27	65	820	0.34	86	1018	0.57	139	1030	0.51	135	791	0.72	196	968
	Low	0.16	44	827	0.17	47	625	0.21	56	682	0.30	72	890	0.47	120	924	0.39	108	638	0.64	159	793

**Table 10: Electrical Data - Standard (Free Discharge) Motor – 3-Row Coil**

	Motor Speed	Size 02			Size 03			Size 04			Size 06			Size 08			Size 10			Size 12		
		Amps	Watts	RPM	Amps	Watts	RPM	Amps	Watts	RPM	Amps	Watts	RPM	Amps	Watts	RPM	Amps	Watts	RPM	Amps	Watts	RPM
115 V	High	0.48	52	1067	0.55	62	1005	0.68	72	994	1.29	121	1120	1.20	129	1018	1.37	149	992	2.48	231	1127
	Med	0.41	43	1007	0.48	53	899	0.57	59	876	1.01	96	976	1.01	108	915	1.15	124	871	1.76	169	1029
	Low	0.34	35	889	0.39	42	722	0.45	45	700	0.89	80	783	0.83	84	749	0.91	95	689	1.60	149	895
208 V	High	0.26	52	962	0.29	62	847	0.38	75	931	0.60	120	1100	0.77	154	1073	0.72	148	865	1.13	230	1117
	Med	0.22	46	784	0.24	52	648	0.30	59	764	0.45	88	900	0.58	48	713	0.57	119	685	0.81	160	975
	Low	0.18	38	583	0.19	42	482	0.25	49	607	0.36	64	664	0.50	39	509	0.45	93	539	0.68	124	733
230 V	High	0.26	55	1034	0.29	66	960	0.37	75	1001	0.62	131	1122	0.80	179	1096	0.72	163	959	1.17	254	1135
	Med	0.22	50	935	0.25	59	803	0.31	64	880	0.42	90	1000	0.57	130	1011	0.60	138	802	0.79	172	1037
	Low	0.19	44	771	0.21	50	604	0.26	6	732	0.36	77	811	0.50	111	879	0.49	113	624	0.69	145	861
265 V	High	0.27	54	1034	0.28	61	942	0.34	77	920	0.46	115	1116	0.79	172	1100	0.65	150	911	0.93	240	1108
	Med	0.20	47	936	0.21	44	789	0.27	64	771	0.35	86	975	0.56	133	1012	0.49	126	742	0.72	182	948
	Low	0.16	41	787	0.17	44	594	0.20	46	605	0.30	68	803	0.47	114	891	0.38	99	601	0.61	148	763
277 V	High	0.28	56	1057	0.29	65	959	0.35	75	958	0.48	130	1123	0.81	183	1113	0.70	159	953	0.95	258	1119
	Med	0.21	49	975	0.22	58	800	0.27	65	820	0.35	87	1007	0.57	139	1035	0.51	134	796	0.70	189	983
	Low	0.16	43	859	0.17	48	622	0.21	56	677	0.30	71	855	0.47	120	933	0.39	108	646	0.62	155	821

**Table 11: Electrical Data - Standard (Free Discharge) Motor – 4-Row Coil**

	Motor Speed	Size 02			Size 03			Size 04			Size 06			Size 08			Size 10			Size 12		
		Amps	Watts	RPM	Amps	Watts	RPM	Amps	Watts	RPM	Amps	Watts	RPM	Amps	Watts	RPM	Amps	Watts	RPM	Amps	Watts	RPM
115 V	High	0.48	52	1069	0.54	61	1019	0.68	71	1002	1.28	118	1127	1.17	126	1027	1.36	152	993	2.46	228	1131
	Med	0.41	43	1007	0.47	52	923	0.57	59	890	0.93	88	1017	0.98	105	935	1.15	123	863	1.73	166	1036
	Low	0.34	35	888	0.38	41	779	0.45	45	712	0.86	77	873	0.81	83	769	0.91	94	684	1.57	147	909
208 V	High	0.26	52	964	0.29	60	859	0.38	74	938	0.60	117	1107	0.75	150	1083	0.71	151	865	1.12	227	1121
	Med	0.22	46	784	0.23	50	665	0.30	59	776	0.41	81	938	0.56	47	729	0.57	118	678	0.80	157	982
	Low	0.18	38	582	0.19	41	520	0.25	49	617	0.35	62	740	0.48	39	523	0.45	92	535	0.67	122	744
230 V	High	0.26	55	1036	0.29	64	973	0.37	74	1009	0.62	128	1129	0.78	175	1106	0.72	166	959	1.16	251	1139
	Med	0.22	50	935	0.24	58	824	0.31	64	894	0.39	83	1042	0.55	127	1034	0.60	137	795	0.78	169	1044
	Low	0.19	44	770	0.20	49	652	0.26	6	745	0.35	74	904	0.49	110	903	0.49	112	619	0.68	143	874
265 V	High	0.27	54	1036	0.28	59	955	0.34	76	927	0.46	112	1123	0.77	167	1110	0.65	153	911	0.92	237	1112
	Med	0.20	47	936	0.21	42	810	0.27	64	783	0.32	79	1016	0.55	130	1034	0.49	125	735	0.71	179	954
	Low	0.16	40	786	0.16	43	641	0.20	46	615	0.29	65	895	0.45	113	915	0.37	98	597	0.60	146	775
277 V	High	0.28	56	1059	0.28	63	972	0.35	74	966	0.48	127	1130	0.79	178	1123	0.70	162	953	0.94	255	1123
	Med	0.21	49	975	0.21	56	821	0.27	65	833	0.32	80	1049	0.55	136	1058	0.51	133	789	0.69	186	990
	Low	0.16	42	858	0.17	46	671	0.21	56	689	0.29	68	953	0.46	119	959	0.39	106	641	0.61	153	834

## Unit Data

**Table 12: Physical Data: Coils, Fans, Motors and Filters**

	02	03	04	06	08	10	12
<b>Primary Coil Data</b>							
Face Area, ft <sup>2</sup> (cm <sup>2</sup> )	0.74 (685)	1.08 (1004)	1.43 (1323)	2.11 (1962)	2.46 (2281)	3.14 (2917)	3.83 (3559)
Fins/inch (cm)	12 [4.7]	12 [4.7]	12 [4.7]	12 [4.7]	12 [4.7]	12 [4.7]	12 [4.7]
Connection Size	1/2" Nominal Copper (5/8" OD)						
<b>Coil Dimensions</b>							
2-Row L x D x H, in (cm)	11.8 x 1.7 x 9 (30.0x4.4x22.9)	17.3 x 1.7 x 9 (43.9x4.4x22.9)	22.8 x 1.7 x 9 (57.9x4.4x22.9)	33.8 x 1.7 x 9 (85.9x4.4x22.9)	39.3 x 1.7 x 9 (99.8x4.4x22.9)	50.2 x 1.7 x 9 (127.6x4.4x22.9)	61.3 x 1.7 x 9 (155.7x4.4x22.9)
3-Row L x D x H, in (cm)	11.8 x 2.6 x 9 (30.0x6.6x22.9)	17.3 x 2.6 x 9 (43.9x6.6x22.9)	22.8 x 2.6 x 9 (57.9x6.6x22.9)	33.8 x 2.6 x 9 (85.9x6.6x22.9)	39.3 x 2.6 x 9 (99.8x6.6x22.9)	50.2 x 2.6 x 9 (127.6x6.6x22.9)	61.3 x 2.6 x 9 (155.7x6.6x22.9)
4-Row L x D x H, in (cm)	11.8 x 3.5 x 9 (30.0x8.8x22.9)	17.3 x 3.5 x 9 (43.9x8.8x22.9)	22.8 x 3.5 x 9 (57.9x8.8x22.9)	33.8 x 3.5 x 9 (85.9x8.8x22.9)	39.3 x 3.5 x 9 (99.8x8.8x22.9)	50.2 x 3.5 x 9 (127.6x8.8x22.9)	61.3 x 3.5 x 9 (155.7x8.8x22.9)
<b>Coil Volume, Gal (Liters)</b>							
2-Row	0.15 (0.6)	0.19 (0.7)	0.24 (0.9)	0.32 (1.2)	0.37 (1.4)	0.46 (1.7)	0.55 (2.1)
3-Row	0.20 (0.7)	0.26 (1.0)	0.32 (1.2)	0.45 (1.7)	0.52 (2.0)	0.64 (2.4)	0.77 (2.9)
4-Row	0.26 (1.0)	0.34 (1.3)	0.43 (1.6)	0.61 (2.3)	0.70 (2.6)	0.87 (3.3)	1.05 (4.0)
<b>Reheat Coil Data: 1-Row, Hot Water or Steam</b>							
Face Area, ft <sup>2</sup> (cm <sup>2</sup> )	0.49 (456)	0.72 (669)	0.95 (882)	1.41 (1308)	1.64 (1521)	2.09 (1944)	2.55 (2372)
Fins/inch (cm)	12 [4.7]	12 [4.7]	12 [4.7]	12 [4.7]	12 [4.7]	12 [4.7]	12 [4.7]
L x D x H, in (cm)	11.8 x 0.9 x 6 (30.0x2.2x15.2)	17.3 x 0.9 x 6 (43.9x2.2x15.2)	22.8 x 0.9 x 6 (57.9x2.2x15.2)	33.8 x 0.9 x 6 (85.9x2.2x15.2)	39.3 x 0.9 x 6 (99.8x2.2x15.2)	50.2 x 0.9 x 6 (127.6x2.2x15.2)	61.3 x 0.9 x 6 (155.7x2.2x15.2)
Connection Size	1/2" Nominal Copper (5/8" OD)						
Volume, Gal (Liters)	0.04 (0.1)	0.05 (0.2)	0.07 (0.3)	0.10 (0.4)	0.11 (0.4)	0.14 (0.5)	0.17 (0.7)
<b>Preheat Coil Data, 2-Row, Hot Water or Steam</b>							
Hot Water or Steam							
Face Area, ft <sup>2</sup> (cm <sup>2</sup> )	0.49 (456)	0.72 (669)	0.95 (882)	1.41 (1308)	1.64 (1521)	2.09 (1944)	2.55 (2372)
Fins/inch (cm)	12 [4.7]	12 [4.7]	12 [4.7]	12 [4.7]	12 [4.7]	12 [4.7]	12 [4.7]
L x D x H, in. (cm)	11.8 x 1.7 x 6 (30.0x4.4x15.2)	17.3 x 1.7 x 6 (43.9x4.4x15.2)	22.8 x 1.7 x 6 (57.9x4.4x15.2)	33.8 x 1.7 x 6 (85.9x4.4x15.2)	39.3 x 1.7 x 6 (99.8x4.4x15.2)	50.2 x 1.7 x 6 (127.6x4.4x15.2)	61.3 x 1.7 x 6 (155.7x4.4x15.2)
Connection Size	1/2" Nominal Copper (5/8" OD)						
Volume, Gal (Liters)	0.08 (0.3)	0.10 (0.4)	0.13 (0.5)	0.19 (0.7)	0.22 (0.8)	0.29 (1.1)	0.35 (1.3)
<b>Fan/Motor Data</b>							
Fan Quantity	1	1	2	2	3	4	4
Size, Dia" x W" (cm)	6.26 x 6.3 (15.9 x 16)	7.95 x 6.3 (20 x 16)	6.26 x 6.3 (15.9 x 16)	7.95 x 6.3 (20 x 16)	6.26 x 6.3 (15.9 x 16)	6.26 x 6.3 (15.9 x 16)	7.95 x 6.3 (20 x 16)
Motor Quantity	1	1	1	1	2	2	2
<b>Filter Data</b>							
Part Number	668332901	668332902	668332903	668332907	668332905	668332906	668332904
1" (25.4 cm) Media	TA only	TA only	TA only	TA only	TA only	TA only	TA only
Quantity	1	1	1	1	2	2	2
L x D x H, in. (cm)	16 x 8.75 x 1 (40.6 x 22 x 2.5)	21.5 x 8.75 x 1 (54.6 x 22 x 2.5)	27 x 8.75 x 1 (68.5 x 22 x 2.5)	38 x 8.75 x 1 (96.5 x 22 x 2.5)	21.7 x 8.75 x 1 (56.1 x 22 x 2.5)	27.2 x 8.75 x 1 (69.0 x 22 x 2.5)	32.7 x 8.75 x 1 (83.1 x 22 x 2.5)

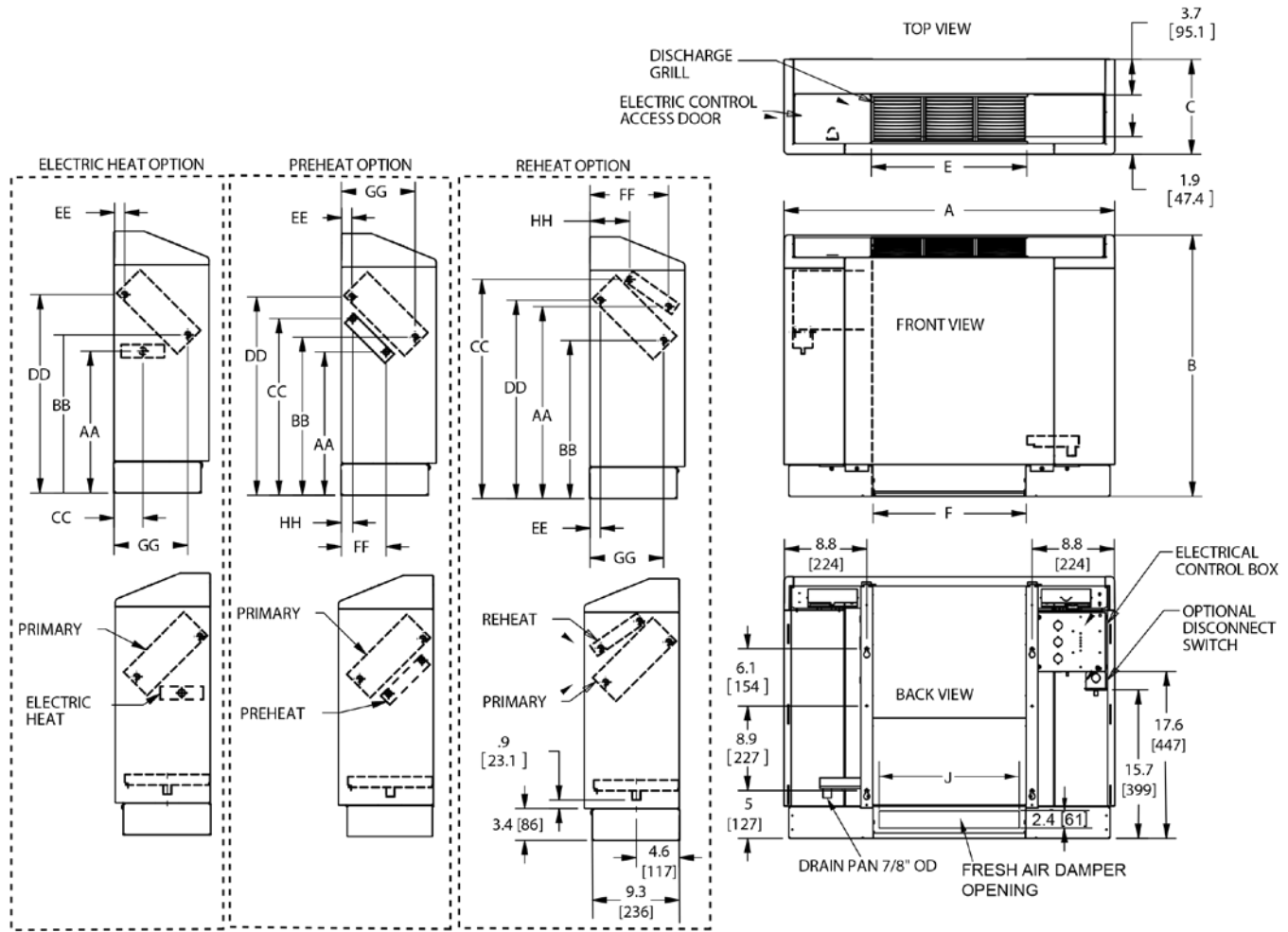
**Table 13: Approximate Shipping Weights - lbs (kg)\***

Unit Type	Unit Size						
	S02	S03	S04	S06	S08	S10	S12
FCVC, FCVS	84 (38)	95 (43)	108 (49)	131 (60)	152 (69)	177 (80)	202 (92)
FCVH	55 (25)	63 (29)	74 (34)	91 (41)	110 (50)	129 (59)	149 (68)

Note: \*Approximate shipping weights do not include valve packages, hot water coils, electric heaters or other options.

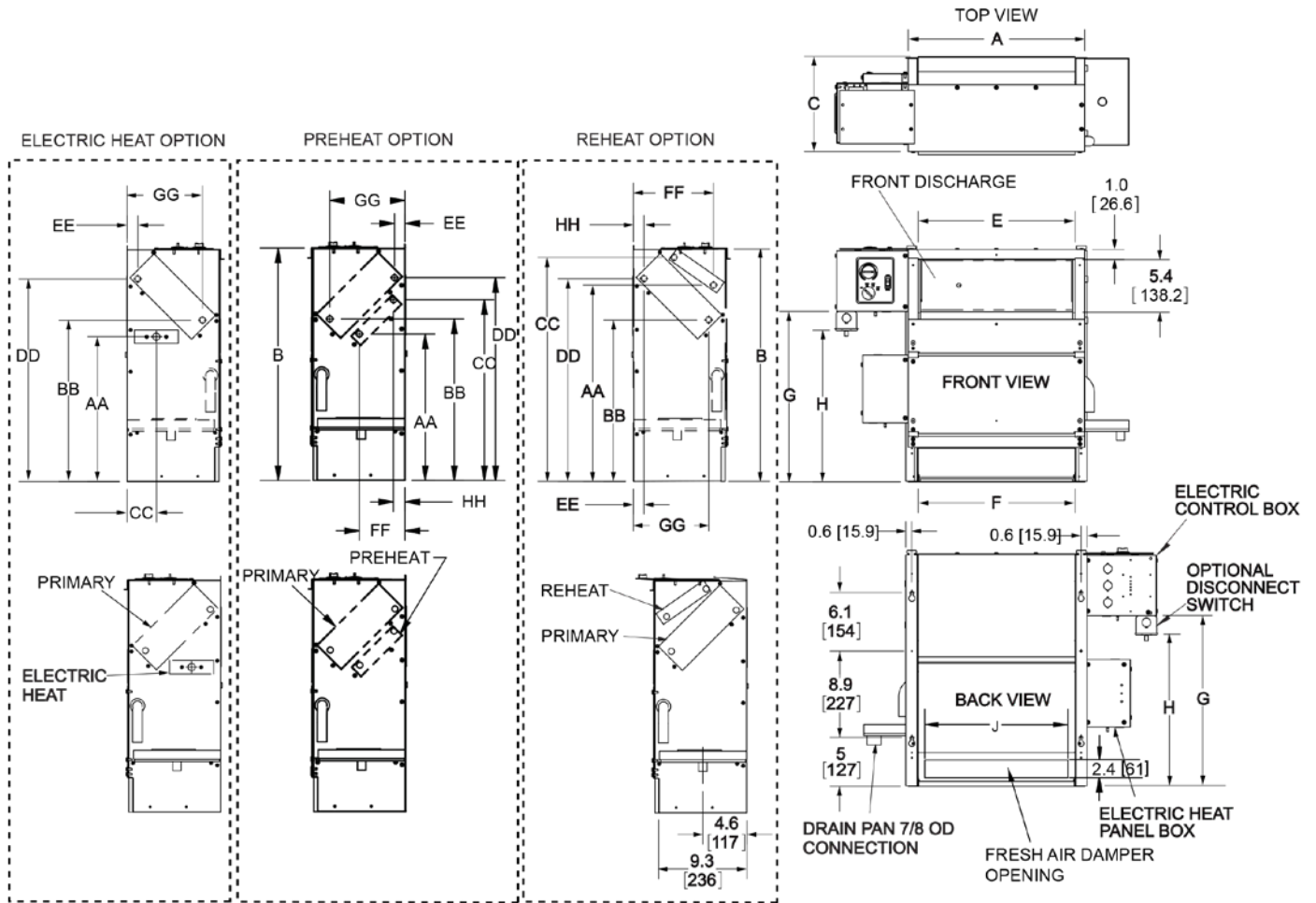


Figure 13: Dimensions: Slope Top Fan Coils



Dimension		S02		S03		S04		S06		S08		S10		S12	
		inch	mm	inch	mm	inch	mm	inch	mm	inch	mm	inch	mm	inch	mm
Unit Width	A	35.0	889	40.5	1029	46.0	1168	57.0	1448	62.5	1588	73.5	1867	84.5	2146
Unit Height	B	27.6	701	27.6	701	27.6	701	27.6	701	27.6	701	27.6	701	27.6	701
Unit Depth	C	10.0	254	10.0	254	10.0	254	10.0	254	10.0	254	10.0	254	10.0	254
Discharge Grille - Width	E	16.3	414	21.8	554	27.3	693	38.3	973	43.8	1113	54.8	1392	65.8	1671
Return Air Opening - Width	F	16.2	411	21.7	551	27.2	691	38.2	970	43.7	1110	54.7	1389	65.7	1669
Electric Heat Connection	AA	15.1	384	15.1	384	15.1	384	15.1	384	15.1	384	15.1	384	15.1	384
	CC	3.0	76	3.0	76	3.0	76	3.0	76	3.0	76	3.0	76	3.0	76
Primary Coil - Water Return	DD	21	533	21	533	21	533	21	533	21	533	21	533	21	533
	EE	1.1	28	1.1	28	1.1	28	1.1	28	1.1	28	1.1	28	1.1	28
Primary Coil - Water Supply	BB	16.7	424	16.7	424	16.7	424	16.7	424	16.7	424	16.7	424	16.7	424
	GG	7.8	198	7.8	198	7.8	198	7.8	198	7.8	198	7.8	198	7.8	198
Preheat Coil - Water Return	CC	18.7	475	18.7	475	18.7	475	18.7	475	18.7	475	18.7	475	18.7	475
	HH	1.2	30	1.2	30	1.2	30	1.2	30	1.2	30	1.2	30	1.2	30
Preheat Coil - Water Supply	AA	15	381	15	381	15	381	15	381	15	381	15	381	15	381
	FF	4.7	119	4.7	119	4.7	119	4.7	119	4.7	119	4.7	119	4.7	119
Reheat Coil - Water Return	CC	23.2	589	23.2	589	23.2	589	23.2	589	23.2	589	23.2	589	23.2	589
	HH	4.2	107	4.2	107	4.2	107	4.2	107	4.2	107	4.2	107	4.2	107
Reheat Coil - Water Supply	AA	20.3	516	20.3	516	20.3	516	20.3	516	20.3	516	20.3	516	20.3	516
	FF	8.3	211	8.3	211	8.3	211	8.3	211	8.3	211	8.3	211	8.3	211
Fresh Air Damper Width	J	10	254	10	254	16	406	16	406	32	813	32	813	32	813

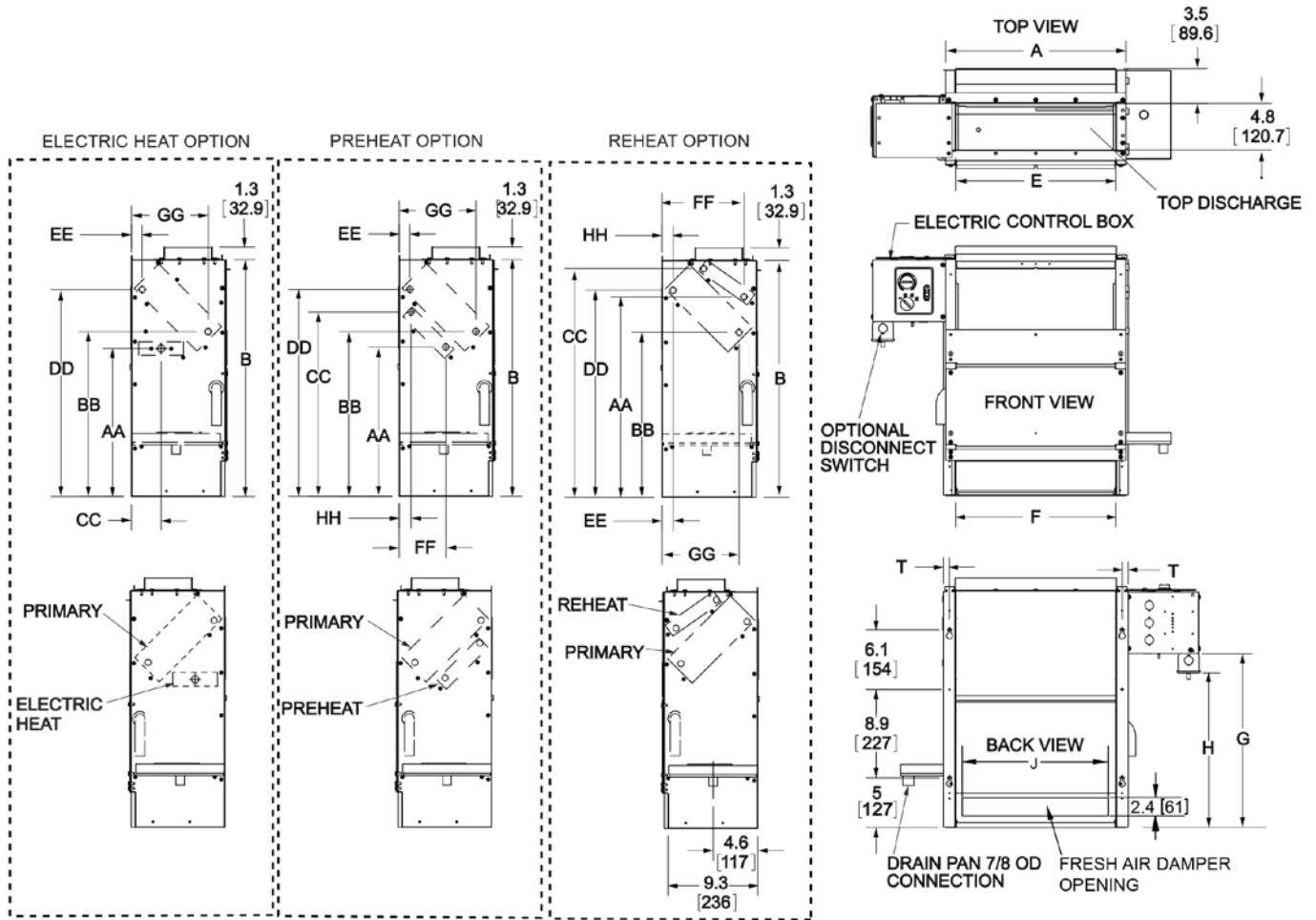
Figure 14: Dimensions: Hideaway, Front-Discharge Fan Coils



Dimension		S02		S03		S04		S06		S08		S10		S12	
		inch	mm	inch	mm	inch	mm	inch	mm	inch	mm	inch	mm	inch	mm
Unit Width	A	18.8	475	24.3	617	29.8	757	40.8	1036	46.3	1176	57.3	1455	68.3	1735
Unit Height	B	24.0	610	24.0	610	24.0	610	24.0	610	24.0	610	24.0	610	24.0	610
Unit Depth	C	9.6	243	9.6	243	9.6	243	9.6	243	9.6	243	9.6	243	9.6	243
Discharge Grille - Width	E	16.3	414	21.8	554	27.3	693	38.3	973	43.8	1113	54.8	1392	65.8	1671
Return Air Opening - Width	F	16.2	411	21.7	551	27.2	691	38.2	970	43.7	1110	54.7	1389	65.7	1669
Control Box to Floor	G	17.6	447	17.6	447	17.6	447	17.6	447	17.6	447	17.6	447	17.6	447
Disconnect Switch to Floor	H	15.7	399	15.7	399	15.7	399	15.7	399	15.7	399	15.7	399	15.7	399
Electric Heat Connection	AA	15.1	384	15.1	384	15.1	384	15.1	384	15.1	384	15.1	384	15.1	384
	CC	3.0	76	3.0	76	3.0	76	3.0	76	3.0	76	3.0	76	3.0	76
Primary Coil - Water Return	DD	21	533	21	533	21	533	21	533	21	533	21	533	21	533
	EE	1.1	28	1.1	28	1.1	28	1.1	28	1.1	28	1.1	28	1.1	28
Primary Coil - Water Supply	BB	16.7	424	16.7	424	16.7	424	16.7	424	16.7	424	16.7	424	16.7	424
	GG	7.8	198	7.8	198	7.8	198	7.8	198	7.8	198	7.8	198	7.8	198
Preheat Coil - Water Return	CC	18.7	475	18.7	475	18.7	475	18.7	475	18.7	475	18.7	475	18.7	475
	HH	1.2	30	1.2	30	1.2	30	1.2	30	1.2	30	1.2	30	1.2	30
Preheat Coil - Water Supply	AA	15	381	15	381	15	381	15	381	15	381	15	381	15	381
	FF	4.7	119	4.7	119	4.7	119	4.7	119	4.7	119	4.7	119	4.7	119
Reheat Coil - Water Return	CC	23.2	589	23.2	589	23.2	589	23.2	589	23.2	589	23.2	589	23.2	589
	HH	4.2	107	4.2	107	4.2	107	4.2	107	4.2	107	4.2	107	4.2	107
Reheat Coil - Water Supply	AA	20.3	516	20.3	516	20.3	516	20.3	516	20.3	516	20.3	516	20.3	516
	FF	8.3	211	8.3	211	8.3	211	8.3	211	8.3	211	8.3	211	8.3	211
Fresh Air Damper Width	J	10	254	10	254	16	406	16	406	32	813	32	813	32	813



Figure 15: Dimensions: Hideaway, Top-Discharge Fan Coils

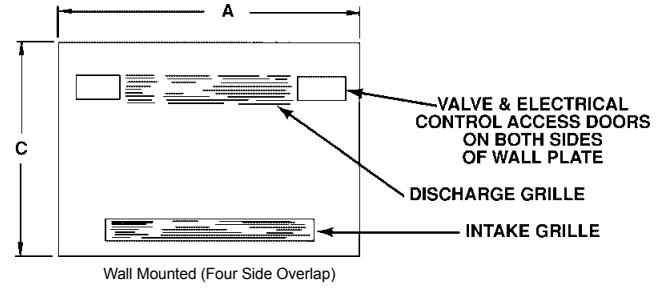


Dimension	S02		S03		S04		S06		S08		S10		S12		
	inch	mm	inch	mm	inch	mm	inch	mm	inch	mm	inch	mm	inch	mm	
Unit Width	A	18.8	475	24.3	617	29.8	757	40.8	1036	46.3	1176	57.3	1455	68.3	1735
Unit Height	B	24.0	610	24.0	610	24.0	610	24.0	610	24.0	610	24.0	610	24.0	610
Unit Depth	C	9.6	243	9.6	243	9.6	243	9.6	243	9.6	243	9.6	243	9.6	243
Discharge Grille - Width	E	16.3	414	21.8	554	27.3	693	38.3	973	43.8	1113	54.8	1392	65.8	1671
Return Air Opening - Width	F	16.2	411	21.7	551	27.2	691	38.2	970	43.7	1110	54.7	1389	65.7	1669
Control Box to Floor	G	17.6	447	17.6	447	17.6	447	17.6	447	17.6	447	17.6	447	17.6	447
Disconnect Switch to Floor	H	15.7	399	15.7	399	15.7	399	15.7	399	15.7	399	15.7	399	15.7	399
Electric Heat Connection	AA	15.1	384	15.1	384	15.1	384	15.1	384	15.1	384	15.1	384	15.1	384
	CC	3.0	76	3.0	76	3.0	76	3.0	76	3.0	76	3.0	76	3.0	76
Primary Coil - Water Return	DD	21	533	21	533	21	533	21	533	21	533	21	533	21	533
	EE	1.1	28	1.1	28	1.1	28	1.1	28	1.1	28	1.1	28	1.1	28
Primary Coil - Water Supply	BB	16.7	424	16.7	424	16.7	424	16.7	424	16.7	424	16.7	424	16.7	424
	GG	7.8	198	7.8	198	7.8	198	7.8	198	7.8	198	7.8	198	7.8	198
Preheat Coil - Water Return	CC	18.7	475	18.7	475	18.7	475	18.7	475	18.7	475	18.7	475	18.7	475
	HH	1.2	30	1.2	30	1.2	30	1.2	30	1.2	30	1.2	30	1.2	30
Preheat Coil - Water Supply	AA	15	381	15	381	15	381	15	381	15	381	15	381	15	381
	FF	4.7	119	4.7	119	4.7	119	4.7	119	4.7	119	4.7	119	4.7	119
Reheat Coil - Water Return	CC	23.2	589	23.2	589	23.2	589	23.2	589	23.2	589	23.2	589	23.2	589
	HH	4.2	107	4.2	107	4.2	107	4.2	107	4.2	107	4.2	107	4.2	107
Reheat Coil - Water Supply	AA	20.3	516	20.3	516	20.3	516	20.3	516	20.3	516	20.3	516	20.3	516
	FF	8.3	211	8.3	211	8.3	211	8.3	211	8.3	211	8.3	211	8.3	211
Fresh Air Damper Width	J	10	254	10	254	16	406	16	406	32	813	32	813	32	813

## Decorative Wall Plate Dimensions

Figure 16: Wall Plate Dimensions and Kit Part Numbers

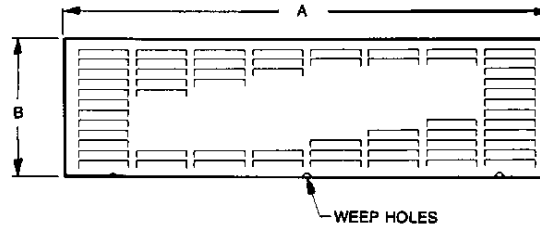
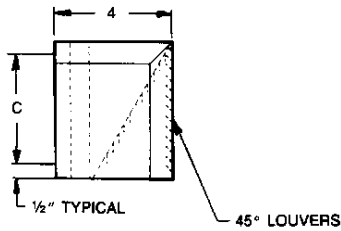
Unit Size	Inches (mm)		Kit Part Number	
	Wall Plate	Recommended Wall Opening	Front Discharge	Top Discharge
02	37.25 × 28.81 (946 × 732)	34 × 26 (864 × 660)	668114901	668114908
03	42.75 × 28.81 (1086 × 732)	40 × 26 (1016 × 660)	668114902	668114909
04	48.25 × 28.81 (1226 × 732)	45 × 26 (1143 × 660)	668114903	668114910
06	59.25 × 28.81 (1505 × 732)	56 × 26 (1422 × 660)	668114904	668114911
08	64.75 × 28.81 (1645 × 732)	62 × 26 (1575 × 660)	668114905	668114912
10	75.75 × 28.81 (1924 × 732)	72 × 26 (1828 × 660)	668114906	668114913
12	86.75 × 28.81 (2203 × 732)	84 × 26 (2134 × 660)	668114907	668114914



**NOTE:** Wall plate is designed for use with ThinLine vertical hideaway units mounted a minimum of 1.5 inches (38 mm) above the floor. Wall plates for Size 08, 10 and 12 units are in two sections. For installation instructions, see Daikin IM 1022

## Fresh Air Intake Box Dimensions

Figure 17: Fresh Air Intake Box Dimensions



Style	Dimensions (Inches)		
	A	B	C
2 Brick × 2 Brick	16 3/4	4 3/4	3 3/4
4 Brick × 4 Brick	33 1/2	4 3/4	3 3/4

## PART 1: GENERAL

### 1.01 SECTION INCLUDES

- A. Vertical Fan Coil

### 1.02 REFERENCES

- A. Load Ratings and Fatigue Life for Ball Bearings.
- B. Standards Handbook.
- C. Laboratory Methods of Testing Fans for Rating Purposes.
- D. Test Code for Sound Rating Air Moving Devices.
- E. Test Methods for Louver, Dampers, and Shutters.
- F. Room Fan Coil Unit.
- G. Standard Practice for Operating Salt Spray Apparatus.
- H. Motors and Generators.
- I. National Electrical Code.
- J. HVAC Duct Construction Standards - Metal and Flexible
- K. Test for Surface Burning Characteristics of Building Materials.
- L. Test Performance of Air Filter Units.
- M. Standard for Heating and Cooling Equipment.
- N. Test for Flammability of Plastic Materials for Parts in Devices and Appliances.

### 1.03 SUBMITTALS

- A. Shop Drawings: Indicate assembly, unit dimensions, weight loading, required clearances, construction details, field connection details, and electrical characteristics and connection requirements.
- B. Product Data
  - 1. Provide literature that indicates dimensions, weights, capacities, ratings, fan performance, gauges and finishes of materials, and electrical characteristics and connection requirements.

### 1.04 OPERATION AND MAINTENANCE DATA

- A. Maintenance Data: Include instructions for lubrication and filter replacement.

### 1.05 QUALIFICATIONS

- A. Manufacturer: Company specializing in manufacturing Air Handler products specified in this section must show a minimum five years documented experience and complete catalog data on total product.

### 1.06 DELIVERY, STORAGE, AND HANDLING

- A. Deliver, store, protect and handle products to site.
- B. Accept products on site wrapped in protective cardboard wrap. Inspect for damage.
- C. Store in a clean dry place and protect from weather and construction traffic. Handle carefully to avoid damage.

### 1.07 ENVIRONMENTAL REQUIREMENTS

- A. Do not operate units for any purpose, temporary or permanent, until ductwork is clean, filters are in place, bearings lubricated, and fan has been test run under observation.

## PART 2: PRODUCTS

### 2.01 ACCEPTABLE MANUFACTURERS

- A. The following manufacturers are approved for use. No substitutions.
  1. Daikin Applied - 'ThinLine 3G' Fan Coil is the basis of design, including standard product features and all special features required per plans and specifications.
  2. ETI
  3. Greenheck

### 2.02 FAN COIL TYPE AND ARRANGEMENT

- A. The fan coil shall be furnished as a draw-through cooling coil with a heating coil in preheat/reheat position.

### 2.03 CABINET

- A. Unit shall be supplied with powder coat painted cabinet. Finish must meet ASTM B117 specifications (salt spray test).
- B. Unit shall be supplied with a decorative wall plate with powder coat paint. Finish must meet ASTM B117 specifications (salt spray test).

### 2.04 GENERAL CONSTRUCTION

- A. Hideaway

### 2.05 SUPPLY FAN

- A. Supply fans shall be a DWDI forward-curved type. Fan assemblies including fan, motor and sheaves shall be dynamically balanced by the manufacturer on all three planes at all bearing supports. Manufacturer must ensure maximum fan RPM is below the first critical speed.
- B. The complete fan assembly, including motor and main drain pan shall be easily removable.

- C. Units shall be certified in accordance with the Room Fan Coil Unit certification program that is based on ARI Standard 440.
- D. An ECM blower motor shall be provided on all units. Factory motor wiring shall be set for optimum fan performance. The unit shall be shipped at one fixed setting. The ECM motor shall utilize a permanent magnet rotor, which is connected to the shaft through resilient rings to absorb high frequency torque ripple. ECM motor shall be programmed for constant CFM or constant torque.
- E. ECM blower motor shall be 3 speeds, single phase with means for proportional field adjustment of each speed.

## 2.06 ELECTRICAL

- A. Supply fans shall be driven by permanent split-capacitor motors that are run-tested in the assembled unit and permanently lubricated. All motors shall have integral thermal overload protection with a maximum ambient operating temperature of 104°F. Motors shall be capable of starting at 78 percent of rated voltage and operating at 90 percent of rated voltage on all speed settings. Motors can operate up to 10 percent overvoltage.
- B. Motor wires shall include a quick-disconnect motor plug.

## 2.07 COOLING AND HEATING

- A. Cooling Coils
  - 1. Cooling performance shall be as specified on the unit schedule.
  - 2. Water coil fins shall have full drawn collars to provide a continuous surface cover over the entire tube for maximum heat transfer. Seamless copper tubes shall be mechanically expanded into the fins to provide a continuous primary-to-secondary compression bond over the entire finned length for maximum heat transfer rates. Bare copper tubes shall not be visible between fins. Coil casing shall be constructed of galvanized steel.
  - 3. Water coils shall be provided with headers of seamless copper tubing with intruded tube holes to permit expansion and contraction without creating undue stress or strain. Coil connections shall be copper sweat connections with connection size to be determined by manufacturer based upon the most efficient coil circuiting. Vent and drain connections shall be furnished on the coil connection, external to the cabinet. Vent connections provided at the highest point to assure proper venting. Drain connections shall be provided at the lowest point.
  - 4. All steel parts exposed to moisture shall be galvanized.
  - 5. Unit shall include a noncorrosive, ABS main drain pan, positively sloped in every plane and insulated with closed-cell insulation. The drain pan shall be designed to ensure no pooling of condensate water per ASHRAE 62.2.

- 6. Water coils shall not exceed an internal pressure of 500 psig.

### B. Water/Steam Heating Coil

- 1. Heating performance shall be as specified on the unit schedule.
- 2. Coil fins shall have full drawn collars to provide a continuous surface cover over the entire tube for maximum heat transfer. Seamless copper tubes shall be mechanically expanded into the fins to provide a continuous primary-to-secondary compression bond over the entire finned length for maximum heat transfer rates. Bare copper tubes shall not be visible between fins.
- 3. Coils shall be provided with headers of seamless copper tubing with intruded tube holes to permit expansion and contraction without creating undue stress or strain. Coil connections shall be copper sweat connections with connection size to be determined by manufacturer based upon the most efficient coil circuiting. Vent and drain connections shall be furnished on the coil connection, external to the cabinet. Vent connections shall be provided at the highest point to ensure proper venting. Drain connections shall be provided at the lowest point.
- 4. Water coils shall not exceed an internal pressure of 500 psig.
- 5. Steam coils shall not exceed an internal pressure of 150 psig.

## 2.08 VALVE PACKAGES

- A. Fan coil units shall be provided with factory-installed valve / piping package(s) available for the primary and secondary coils. All piping packages shall be factory assembled and tested at 400 psig (2760 kPa) and re-tested for leak when factory soldered to the coil(s) at 300 psig (2069 kPa). Maximum Working Pressure of the piping package shall be 300 psig (2069 kPa).
- B. The valve package shall be designed so that any condensation is directed into the secondary drain pan. With the secondary drain pan provided, insulation of the piping package is not required.
- C. The valve package shall be provided with:
  - 1. Interconnecting copper piping and shut-off ball valves.
  - 2. Connecting supply and return lines to the unit. Four-pipe packages shall include a venting valve for the preheat or reheat coil.
  - 3. A manual circuit setter in the supply water pipe. The circuit setter acts as both a flow-setting device and a shut-off valve. It allows water flow through the fan coil to be set quickly and accurately. The valve shall have a memory stop so that the correct setting can be found quickly.
  - 4. An automatic circuit setter. The circuit setter includes a cartridge within the valve body that is sized to allow a specific flow rate through the coil. This valve sets flow through the coil without any action required by a system piping balancer.

5. P/T ports to measure the temperature or pressure drop across the valve. This pressure drop can be compared to factory-supplied curves that relate the pressure drop to a specific flow rate.
6. Unions at the coil connections.
7. A 20 mesh strainer on the supply side that is easily removed for cleaning, with a blow-off valve. The strainer shall have a pressure rating of up to 400 psig (2,758 kPa).
8. Isolating ball valve on the supply side.
9. Balancing flow valve ( auto-fixed or manual) with isolating ball valve on the return.
10. Control valves in the supply water pipe.
11. Two-Way/Two-Position Valves that are fully open or fully closed in response to a line voltage (115 or 265-277 VAC) or a 24 VAC signal from the Daikin Applied thermostat or controller. Some means of relieving pump head pressure should be accounted for when two-way valves are selected. Normally open or normally closed valves are available. Both are spring-return.
12. Three-Way, Two-Position Valves that either allow full water flow through the coil or divert the flow through a bypass line. The valves respond to a line voltage (115 or 265-277 VAC) or to a 24 VAC signal from the Daikin Applied thermostat or controller. All standard three-way valves come with a fixed-balance orifice in the bypass line to compensate for flow balancing in the bypass position, eliminating the need for an additional balancing valve. Normally open or normally closed valves are available.
13. Two-Way Modulating Valves that modulate the water flow through the coil in response to a signal from the Daikin Applied thermostat or controller. All standard Daikin Applied modulating valves are three-wire floating point equal percentage valves. The modulating valves are factory mounted in the supply water pipe upstream of the coil.
14. Three-Way Modulating Valves that modulate the water flow through the coil in response to a signal from the Daikin Applied thermostat or controller. Three-way valves allow water that is directed through the coil to mix with water that is directed through the bypass line. This mixture exits through the leaving water pipe. All modulating valves are three-wire, floating-point equal percentage valves.

## 2.09 FILTERS

- A. Filters shall be 1" (25 mm) throwaway. They shall be concealed from sight and easily removable.

## 2.010 MICROTECH CONTROLS

- A. The unit control board shall be the main component of the system and shall contain the required inputs/ outputs to operate a fan coil unit.
- B. Unit controller inputs/outputs: The MicroTech controller will be microprocessor-based and have capabilities, performance, and memory sufficient to execute the various functions detailed in this specification. This document will not specify a type, a manufacturer, or a family of microcontrollers to be considered for use. However, at a minimum, the following features are deemed essential:
  1. Analog Inputs: Room or Return Temperature & Timed Override Switch, Condensate Overflow, Set point Adjust, Fan Speed Switch, Heat/Cool/ Auto Switch, Entering Water Temperature, Discharge Air Temperature.
  2. Condensate Overflow. The presence of excessive condensate in the condensate drain pan is detected by a condensate sensor, which consists of a metal terminal ring mounted just below the top of the condensate pan. The analog input dedicated to condensate sensing must be capable of detecting the conductivity of water between the ring terminal and chassis ground. The conductivity trip point is 2.5 micro-ohms.
  3. Set point Adjust. The Set point Adjust range will be interpreted by the base controller as an offset to the current temperature setpoint -5 to +5 degrees F or a range of 55 to 95 degrees F (software jumper selectable and scaled accordingly in software).
  4. Heat/Cool/Auto - The Room Sensor shall incorporate a voltage signal that present different values to a single analog input which correspond to the unit operating mode functions detailed below. The room sensor is designed with specific voltage values to coincide with the software in unit control module.  
0.0v = Cool, 1.0v = Auto, 2.5v = Heat, 5.0v = Switch not present.
  5. Fan Speed Switch - The Room Sensor shall incorporate a voltage signal that present different voltage values to a single analog input which correspond to the fan speed mode functions detailed below. The room sensor is designed with specific voltage values to coincide with the software in unit control module.  
0.0v = Auto, 1.0v = High, 2.0v = Medium, 3.0v = Low, 4.0v = OFF, 5.0v = Switch is not present.

6. Temperature Input. Sensing element in the MicroTech room temperature sensor is equivalent to NTC Thermistor – 10K ohms @ 25°C, 0.2°C interchangeability. Advanced Thermal Products – Curve Z. **NOTE:** The Timed (Tenant) Override switch will short out the Room sensor thermistor. Sensing range shall be 0 to 158°F with a resolution of 1°F and an accuracy of +/- 1.5°F Maximum Total Error.

7. Binary Inputs. 2 total (Freeze Fault Detection, Occupancy Sensor)

The Freeze Fault Detection switch shall be sourced with 24VAC or DC, +/-20%. The binary input detection circuit shall be designed such that a minimum of 7mA current flows through the external contacts. Unoccupied Mode: this binary input will detect the presence of an earth-grounded signal, which is supplied by an external, remote set of contacts.

C. Binary Outputs: 9 total (Fan Low Speed, Fan Medium Speed, Fan High Speed, Valve Output #1, Valve Output #2, Valve Output #3, or Electric Heat Stage 1, Valve Output #4 or Electric Heat Stage 2, 2 Position Damper, Room Sensor Status LED).

1. Fan Speed Outputs -There are three fan speed outputs on baseboard. If all three outputs are de-energized, the fan motor is off. Only a single type (low, medium, high) of speed output shall be turned on when fan operation is required.

Low Speed: this binary output is used to operate the fan at low speed. If this output is energized, the fan operates at low speed.

Medium Speed: this binary output is used to operate the fan at medium speed. If this output is energized, the fan operates at medium speed.

High Speed: this binary output is used to operate the fan at high speed. If this output is energized, the fan operates at high speed.

2. Two-Position Damper Output: Binary output may be used to open a fresh air ventilation damper. If the output is de-energized, the damper is closed. If the output is energized, the damper is open.

3. Room Sensor Status Output: Binary output may be used to energize and de-energize an indicator located on the room sensor. See Room Sensor Status Output Annunciation Table.

D. Automatic Fan speed selection.

1. When the fan mode/speed switch is in the “Auto” position and capacity is required, the fan speed is determined automatically based on the amount of error from the respective heating or cooling on setpoint. If the room temperature error exceeds 4°F (2.22°C), the fan will be “forced on” in the highest available fan speed. Once the room temperature error falls below 3°F (1.67°C), the fan will no longer be “forced on” in the highest available fan speed. If the “Highest Speed Force On” is not active the fan will start at low speed, and fan speed changes are determined by whether the room temperature is above or below the effective controlling on setpoint.

E. Valve and Electric Heat Control

1. The controller will be factory configurable for the following valve and electric heat control configurations.

Pipe Cooling Only Valve	2-Pipe Hydronic Cooling with 2-Position Valve
	2-Pipe Hydronic Cooling with Modulating Valve
	2-Pipe Hydronic Cooling with 2-Position Valve with Electric Heat
2-Pipe Heating Only Valve	2-Pipe Hydronic Heating with 2-Position Valve
	2-Pipe Hydronic Heating with Modulating Valve
	2-Pipe Hydronic Heating with 2-Position Valve with Electric Heat
	2-Pipe Hydronic Heating with Modulating Valve with Electric Heat
2-Pipe Changeover Valve	2-Pipe Hydronic Heating or Cooling Changeover with 2-Position Valve
	2-Pipe Hydronic Heating or Cooling Changeover with Modulating Valve
	2-Pipe Hydronic Heating or Cooling Changeover with 2-Position Valve with Electric Heat
	2-Pipe Hydronic Heating or Cooling Changeover with Modulating Valve with Electric Heat
4-Pipe, 2-Valves	4-Pipe Hydronic Heating and Cooling with 2-Position Valve
	4-Pipe Hydronic Heating and Cooling with Modulating Valve
Electric Heat Only	Electric Heat Only

**F. Software Jumpers**

- Software Jumpers will be designed into the MicroTech Fan Coil controller and used to modify controller configuration to match equipment configuration. The values of the jumper's (zero or one) shall set valve operation, fan operation, etc. Software Jumper definitions are below.

Function	Bit/Binary Setting	Model/Feature
Service Test Mode	Byte 1: b0	0 = Normal Operation 1 = Service Test Mode
Continuous/Cycling Fan	Byte 1: b1	0 = Continuous Fan 1 = Cycling Fan
Setpoint Adjust – Temperature Range	Byte 1: b2	0 = Short Range (-5 – +5°F) 1 = Long Range (55 to 95°F)
IO Expansion Board Selection	Byte1: b3	0 = No IO Expansion Board Present 1 = Enable IO Expansion Board
Economizer Selection	Byte 1: b4	0 = No Economizer Present 1 = Enable Economizer Use
N.O./N.C. 2-Position Heating Valve	Byte 1: b5	0 = Normally Open Heating Valve 1 = Normally Closed Heating Valve
N.O./N.C. 2-Position Cooling Valve	Byte 1: b6	0 = Normally Open Cooling Valve 1 = Normally Closed Cooling Valve
2-Position/Modulating Valves	Byte 1: b7	0 = 2-position Hydronic Valves 1 = Modulating Hydronic Valves
Heating Selection	Byte 2: b1=0,b0=0 Byte 2: b1=0,b0=1 Byte 2: b1=1,b0=0	00 = No Electric Heating 01 = 1-Stage Electric Heat 10 = 2-Stage Electric Heat (Future) 11 = Not Valid
Hydronic Valves Selection	Byte 2: b4=0,b3=0,b2=0 Byte 2: b4=0,b3=0,b2=1 Byte 2: b4=0,b3=1,b2=0 Byte 2: b4=0,b3=1,b2=1 Byte 2: b4=1,b3=0,b2=0	000 = No Hydronic Valves 001 = 2-Pipe Heating Only 010 = 2-Pipe Cooling Only 011 = 2-Pipe Heat & Cool Changeover 100 = 4-Pipe Hydronic Heat & Cool
Fan Speed Selection	Byte 2: b6=0,b5=0 Byte 2: b6=0,b5=1 Byte 2: b6=1,b5=0	00 = 1-Speed (Uses: High) 01 = 2-Speed (Uses: Low, High) 10 = 3-Speed (Uses: Low, Medium, High)
Freeze Fault Detect Binary Input Selection	Byte 2: b7	0 = Disable Binary Input 1 = Enable Binary Input
Emergency Shutdown Binary Input Selection	Byte 3: b0	0 = Disable Binary Input 1 = Enable Binary Input
Dirty Air Filter Binary Input Selection	Byte 3: b1	0 = Disable Binary Input 1 = Enable Binary Input

- Intelligent Reset: (Condensate Overflow Alarm). The “Fault Retry” feature helps to minimize nuisance trips of automatic lockouts caused by low-pressure or low temperature faults. This feature automatically clears these faults the first two times they occur within a 24-hour period and triggers an automatic lockout on the 3rd fault. The retry count is reset to zero every 24 hours. The fault retry feature does not apply to a high pressure fault – which causes an immediate lockout and requires a manual reset, or condensate overflow or brownout faults – which are self-clearing.

- MicroTech Unit Controller Status LED: Remote LED boards will provide visual feedback.

- Room Sensor Status LED: A 5VDC signal and shall operate as follows:

Condition	LED ON Time (sec)	LED OFF Time (sec)
Alarm Active: specific alarm determines number of flashes	0.3	0.3 (1.3 between cycles)
Calibration or Network Wink Activity	3.0	3.0
Service Test Mode	0.0	Continually
Unoccupied Mode	0.5	5.5
Standby Mode	5.5	0.5
Occupied, Bypass Mode	Continually	0.0

- Warranty - The contractor shall provide one full year warranty for furnishing parts on site which becomes defective in normal operation, from the date of start-up by the manufacturer's representative, or first beneficial use of the unit.
  - Manufacturer's warranty time periods may or may not coincide with the contractor's time period of obligation, but where the manufacturer's warranty contains an expiration date based upon the equipment shipping date, the contractor shall not be relieved of responsibility for covering the full time periods listed above.
  - The contractor shall be responsible for all shipping expenses not included by the manufacturer, both to procure the replacement part, and to return any defective parts to the manufacturer, as they may require.
  - The contractor's replacement warranty obligation after the first year shall be limited to furnishing of replacement parts only, and shall not include repair labor costs or materials such as refrigerant, oils, dehydration, refrigerant- moisture dryers, air filters, or drive belts.
  - The owner shall be responsible for providing replacement filters beyond the spares provided in the original contract, and for filter installation labor.

## **PART 3: EXECUTION**

### **3.01 INSTALLATION**

- A. The Thinline Fan Coil unit shall be installed per manufacturer's Installation & Maintenance Bulletin.
  - 1. Selected field mounted kits shall be specified on the unit schedule and installed per manufacturer's instruction.







### ***Daikin Applied Training and Development***

Now that you have made an investment in modern, efficient Daikin equipment, its care should be a high priority. For training information on all Daikin HVAC products, please visit us at [www.DaikinApplied.com](http://www.DaikinApplied.com) and click on Training, or call 540-248-9646 and ask for the Training Department.

### ***Warranty***

All Daikin equipment is sold pursuant to its standard terms and conditions of sale, including Limited Product Warranty. Consult your local Daikin Applied Representative for warranty details. To find your local Daikin Applied Representative, go to [www.DaikinApplied.com](http://www.DaikinApplied.com).

### ***Aftermarket Services***

To find your local parts office, visit [www.DaikinApplied.com](http://www.DaikinApplied.com) or call 800-37PARTS (800-377-2787). To find your local service office, visit [www.DaikinApplied.com](http://www.DaikinApplied.com) or call 800-432-1342.

This document contains the most current product information as of this printing. For the most up-to-date product information, please go to [www.DaikinApplied.com](http://www.DaikinApplied.com).

Products manufactured in an ISO Certified Facility.